

AG2

*Elevate
the Game*



ICE 2025 | Product Catalog

CONTENTS

MUSO CURVE-55 HYBRID

MUSO CURVE-55 Hybrid (Cabinet Feature)	4
Triple Treasure Pot Series	5
Triple Treasure Pot Eternal Prosperity	6
Triple Treasure Pot Heavenly Wealth	7
Long Fu Zhu Series	8
Long Fu Zhu Mongol Storm	9
Long Fu Zhu Panda Strike	10
Xin Yun Qiu Series	11
Xin Yun Qiu Dragon	12
Xin Yun Qiu Lion	13
Bingo Jackpot Series	14
Bingo Jackpot Las Vegas	15
Bingo Jackpot New York	16
Power Tower Series	17
Power Tower Dragon	18
Power Tower Lion	19
Double Firestorm Series	20
Double Firestorm Buffalo	21
Double Firestorm Wolf	22
Pow Pow Panda Series	23
Pow Pow Panda Gong Fortune	24
Pow Pow Panda Gong Jewelry Extreme	25

MUSO TRIPLE-32 HYBRID

MUSO TRIPLE-32 Hybrid (Cabinet Feature)	26
Tomb Treasure Series	27
Tomb Treasure Cleopatra Legend	28
Tomb Treasure Pharaoh Gold	29
Tomb Treasure Sphinx Gold	30
Lightning Arrow Series	31
Lightning Arrow Dragon Tiger Supremacy	32
Lightning Arrow Twin Kingdom	33
Qian Duo Duo Series	34
Qian Duo Duo Dragon	35
Qian Duo Duo Ox	36
Fortune Key Series	37
Fortune Key First Emperor	38
Fortune Key Jade Empress	39

HYPERSPEED

HYPERSPEED (Cabinet Feature)	40
Gong Cash Series	41
Gong Cash Dragon	42
Gong Cash Lion	43
Fu Jin Shu Series	44
Fu Jin Shu Dragon	45
Fu Jin Shu Phoenix	46
Cai Yun Lai Series	47
Cai Yun Lai Dragon	48
Cai Yun Lai Lion	49
Cai Yun Lai Panda	50

Fu Ru Yi Series	51
Fu Ru Yi Phoenix	52
Fu Ru Yi Kirin	53
Firestorm Series	54
Firestorm Bull	55
Firestorm Lion	56
Gong Gong Lai Fu Series	57
Gong Gong Lai Fu Caishen Riches	58
Gong Gong Lai Fu Mighty Buddha	59

SPEED

SPEED (Cabinet Feature)	60
Fortune Frame Series	61
Fortune Frame Dragon Bounty	62
Fortune Frame Panda Carnival	62
Coin Collector Series	63
Coin Collector Apex God	64
Coin Collector Apex Tiger	64
Coin Collector 5 Guardians	65
Coin Collector Aussie 5	65
Fu Lai Cai Lai Series	66
Fu Lai Cai Lai 5 Sea Legends	67
Fu Lai Cai Lai Triple Festival	67
Fu Lai Cai Lai Stack Wild Luxury	67
Fortune Drums Series	68
Fortune Drums Dragon Boat	69
Fortune Drums Zodiac Beasts	69
Fortune Drums Bag of Wealth	70
Fortune Drums Chinese Luxury	70
Bomb Collector Series	71
Bomb Collector Gold Heist	72
Bomb Collector Treasure Heist	72
Co Co Coin Series	73
Co Co Coin Egyptian Treasure	74
Co Co Coin Pirates Treasure	74
Gong Gong Lai Fu Series	75
Gong Gong Lai Fu Caishen Riches	76
Gong Gong Lai Fu Mighty Buddha	76

LPM

LPM Series	77
LPM Multi Game	78

iGaming

iGaming	79
---------	----

PRODUCTS

At Aruze Gaming, we focus on creative innovations that produce the best gaming experience for players and supply premium quality products with outstanding service to our customers across the globe.



Speed Cabinet, a premium speed LCD touch screen cabinet with dual 27" monitors and a 27" topper.



HyperSpeed Cabinet, a premium speed LCD touch screen cabinet with a 43" monitor and a 27" topper.



The Muso Triple-32HB has a stunning new honeycomb cabinet LED display to attract players. Thoughtful touches to keep them comfortable. All designed for an unparalleled gaming experience.



The Muso Curve-55HB has a stunning new honeycomb LED display to attract players. Crafted with thoughtful touches to keep them comfortable. Designed for an unparalleled 55-inch full screen dynamic gaming experience.

Please contact your Account Executive for more details.

sales@aruzeglobal.com

+1 702-781-8080

www.aruzeglobal.com

Follow us @AruzeGaming



Empire Technological Group Ltd dba
Aruze Gaming Global

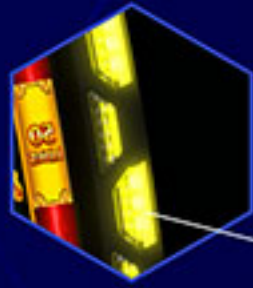

New honeycomb LED (Details)



New vertical 55-inch J-Style curved LCD monitor



New Face Design



MUSO™
CURVE-SSHB

Being the only one of its kind: unlike anything else.

A stunning new honeycomb cabinet LED display to attract players.

Thoughtful touches to keep them comfortable.

All designed for an unparalleled 55-inch full screen dynamic gaming experience.

DIMENSION

Upright Height (Tower Light Included)
2756.9 mm (108.3 in)

Upright Height (Tower Light Excluded)
2652.5 mm (104.4 in)

Width
810 mm (31.9 in)

Depth
838.2 mm (33 in)

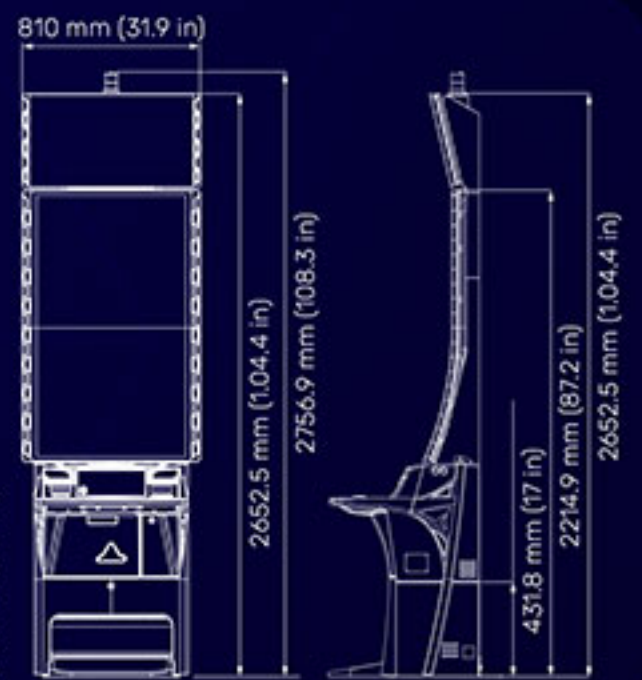
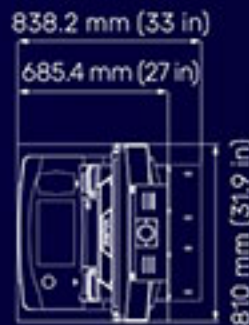

BUILT FOR EXCELLENCE

Please contact your Account Executive for more details.

sales@aruzeglobal.com

+1 702-781-8080

www.aruzeglobal.com

Follow us @AruzeGaming   



Empire Technological Group Ltd dba
Aruze Gaming Global

TRIPLE TREASURE POT



Win big
with a wealth of
multiple features!



Also available in other Cabinets



TYPE OF PRODUCT

LINK / SAP

REEL CONFIGURATION

5-Reel 4-Row Video Slot
5-Reel 6-Row (During the Ox Feature only)

PAYLINES

50 Lines
100 Lines (During the Ox Feature only)

SA DENOMINATIONS

1	2	3
R0.01	R0.02	R0.05
R0.10	R0.20	R0.50
R1	R2	R5

EU DENOMINATIONS

1	2	3
€0.01	€0.02	€0.05
€0.10	€0.20	€0.50
€1	€2	€5

BET CONFIGURATIONS

1, 2, 3, 6, 10

MIN/MAX BET & Cost to Cover

MIN BET	MAX BET	Cost to Cover	Denomination
88	880	88	Denomination 1
88	528	88	Denomination 2
88	264	88	Denomination 3

(Depends on the above Bet Configurations)



TIGER FEATURE



There is a chance that the TIGER FEATURE is triggered when 1 or more appear. TIGER FEATURE awards 5 free spins. Any reel with 1, 2 or 3 nudges to show 4 when any ACTION SYMBOL appears on reel 5. Line wins are determined only once before any reel nudge occurs. Prizes on are won only once after any reel nudge occurs. Any other FEATURE triggered during the TIGER FEATURE starts after the TIGER FEATURE ends, except ACTION PRIZES FEATURE.

DRAGON FEATURE



There is a chance that the DRAGON FEATURE is triggered when 1 or more appear. DRAGON FEATURE awards 10 free spins. Different reels are used during the DRAGON FEATURE. 1 of the following is displayed on each .

- CREDIT PRIZE: 100, 500 or 1000 credits multiplied by bet multiplier as displayed.
- MINI, MINOR, MAJOR or GRAND

Each CREDIT PRIZE displayed on is won. Each MINI, MINOR, MAJOR or GRAND displayed on is collected in its corresponding meter on the screen. Each appearing awards 1 additional free spin and up to 5 can be awarded only.

OX FEATURE



There is a chance that the OX FEATURE is triggered when 1 or more appear. OX FEATURE awards 5 free spins. Different reels are used during the OX FEATURE. Before the OX FEATURE starts, all reels are expanded upward 2 rows of symbols. Any other FEATURE triggered during the OX FEATURE starts after the OX FEATURE ends, except ACTION PRIZES FEATURE.

ACTION PRIZES FEATURE



Any combination of 1 or more and 1 ACTION SYMBOL trigger the corresponding ACTION PRIZE shown below.

ACTION SYMBOL	ACTION PRIZE
	Each prize displayed is won.
	Each prize displayed on is won after being increased by the credit value displayed on .
	Each displayed on is won after being multiplied by the multiplier displayed on .



Also available in other Cabinets



TYPE OF PRODUCT

LINK / SAP

REEL CONFIGURATION

5-Reel 4-Row Video Slot
5-Reel 6-Row (During the Ox Feature only)

PAYLINES

50 Lines
100 Lines (During the Ox Feature only)

SA DENOMINATIONS

1	2	3
R0.01	R0.02	R0.05
R0.10	R0.20	R0.50
R1	R2	R5

EU DENOMINATIONS

1	2	3
€0.01	€0.02	€0.05
€0.10	€0.20	€0.50
€1	€2	€5

BET CONFIGURATIONS

1, 2, 3, 6, 10

MIN/MAX BET & Cost to Cover

MIN BET	MAX BET	Cost to Cover	Denomination
88	880	88	Denomination 1
88	528	88	Denomination 2
88	264	88	Denomination 3

(Depends on the above Bet Configurations)



TIGER FEATURE



There is a chance that the TIGER FEATURE is triggered when 1 or more appear. TIGER FEATURE awards 5 free spins. Any reel with 1, 2 or 3 nudges to show 4 when any ACTION SYMBOL appears on reel 5. Line wins are determined only once before any reel nudge occurs. Prizes on are won only once after any reel nudge occurs. Any other FEATURE triggered during the TIGER FEATURE starts after the TIGER FEATURE ends, except ACTION PRIZES FEATURE.

DRAGON FEATURE



There is a chance that the DRAGON FEATURE is triggered when 1 or more appear. DRAGON FEATURE awards 10 free spins. Different reels are used during the DRAGON FEATURE. 1 of the following is displayed on each .

- CREDIT PRIZE: 100, 500 or 1000 credits multiplied by bet multiplier as displayed.
- MINI, MINOR, MAJOR or GRAND

Each CREDIT PRIZE displayed on is won. Each MINI, MINOR, MAJOR or GRAND displayed on is collected in its corresponding meter on the screen. Each appearing awards 1 additional free spin and up to 5 can be awarded only.

OX FEATURE



There is a chance that the OX FEATURE is triggered when 1 or more appear. OX FEATURE awards 5 free spins. Different reels are used during the OX FEATURE. Before the OX FEATURE starts, all reels are expanded upward 2 rows of symbols. Any other FEATURE triggered during the OX FEATURE starts after the OX FEATURE ends, except ACTION PRIZES FEATURE.

ACTION PRIZES FEATURE



Any combination of 1 or more and 1 ACTION SYMBOL trigger the corresponding ACTION PRIZE shown below.

ACTION SYMBOL	ACTION PRIZE
	Each prize displayed is won.
	Each prize displayed on is won after being increased by the credit value displayed on .
	Each displayed on is won after being multiplied by the multiplier displayed on .

LONG FUZHU



Feel the heat
of the dragon's
breath unlocking
superb wins!



Also available in other Cabinets



TYPE OF PRODUCT

LINK / SAP

REEL CONFIGURATION

5-Reel 3-Row Video Slot

PAYLINES

50 Lines (Denomination 1, 2)
25 Lines (Denomination 3, 4, 5)
5 Lines (Denomination 6, 7, 8)

SA DENOMINATIONS

1	2	3	4	5	6	7	8
R0.01	R0.02	R0.05	R0.10	R0.20	R1	R2	R5
R0.05	R0.10	R0.25	R0.50	R1	R5	R10	R25
R0.10	R0.20	R0.50	R1	R2	R10	R20	R50
R0.50	R1	R2.50	R5	R10	R50	R100	R250
R1	R2	R5	R10	R20	R100	R200	R500

EU DENOMINATIONS

1	2	3	4	5	6	7	8
€0.01	€0.02	€0.05	€0.10	€0.20	€1	€2	€5
€0.05	€0.10	€0.25	€0.50	€1	€5	€10	€25
€0.10	€0.20	€0.50	€1	€2	€10	€20	€50
€0.50	€1	€2.50	€5	€10	€50	€100	€250
€1	€2	€5	€10	€20	€100	€200	€500

BET CONFIGURATIONS

1, 2, 3, 4, 5
1, 2, 3, 5, 8
1, 2, 3, 5, 10
1, 2, 5, 10, 20

MIN/MAX BET & Cost to Cover

MIN BET	MAX BET	Cost to Cover	Denomination
80	1600	80	Denomination 1, 2
40	800	40	Denomination 3, 4, 5
8	160	8	Denomination 6, 7, 8

(Depends on the above Bet Configurations)



FREE GAMES FEATURE



Any 3 appearing on reels 2, 3 and 4 trigger the FREE GAMES FEATURE with 6 free games. Reels used during the FREE GAMES FEATURE contain a greater total number of .

FREE GAMES FEATURE can be triggered again during the FREE GAMES FEATURE. FREE GAMES FEATURE starts after the DRAGON ORB FEATURE ends if triggered in the same game. If triggered in the same game, the FREE GAMES FEATURE starts after the DRAGON ORB FEATURE ends.

DRAGON ORB FEATURE



Any 6 or more appearing in a bought game or free game trigger the DRAGON ORB FEATURE. When DRAGON ORB FEATURE is triggered, 3 free spins are awarded. During the DRAGON ORB FEATURE, each symbol position becomes an individual spinning bonus reel.

Before the DRAGON ORB FEATURE starts, all reels are expanded upward 1 row of symbols and reel 5 is locked. In each free spin, reel 5 is locked if no new appearing on the reels. At the start of DRAGON ORB FEATURE, only 6 appear on random symbol positions on reels 1, 2, 3 and 4 and are held in the position for the duration of the DRAGON ORB FEATURE. In each free spin, any newly appearing unlock reel 5 for that spin only. Any newly appearing in a free spin unlocks the reel 5, and resets the number of remaining free spins to 3 and is held in position until the DRAGON ORB FEATURE ends.

PRIZES	ACTION PRIZE
MULTIPLIER x2, x3 or x8	Each prize displayed on held appearing on the same row in which the MULTIPLIER appears is being multiplied by that MULTIPLIER.
PRIZE AMOUNT (30 LINES) each equal to 5, 40, 80, 160, 190, 250 or 280 credits multiplied by bet multiplier as displayed	Each prize displayed on held appearing on the same row in which the PRIZE AMOUNT appears is increased by that PRIZE AMOUNT.
PRIZE AMOUNT (25 LINES) each equal to 5, 20, 25, 40, 60, 75, 100 or 125 credits multiplied by bet multiplier as displayed	Each prize displayed on held appearing on the same row in which the PRIZE AMOUNT appears is increased by that PRIZE AMOUNT.
PRIZE AMOUNT (5 Lines) each equal to 5, 4, 5, 5, 15, 15, 25 or 25 credits multiplied by bet multiplier as displayed	Each prize displayed on held appearing on the same row in which the PRIZE AMOUNT appears is increased by that PRIZE AMOUNT.
BONUS WINNERS ONLY	Each prize displayed on held appearing on the same row in which the BONUS appears is increased by that BONUS.

When the reel 5 unlocks, it will spin automatically and each symbol position displayed one of the available prizes. DRAGON ORB FEATURE ends after all awarded free spins have been played or if appear in all 16 symbol positions on reels 1, 2, 3 and 4.



MYSTERY JACKPOT AWARD

There is a chance that the GRAND JACKPOT is randomly won in bought games except when FREE GAMES FEATURE or DRAGON ORB FEATURE is triggered.



Also available in other Cabinets



TYPE OF PRODUCT

LINK / SAP

REEL CONFIGURATION

5-Reel 3-Row Video Slot

PAYLINES

50 Lines (Denomination 1, 2)
25 Lines (Denomination 3, 4, 5)
5 Lines (Denomination 6, 7, 8)

SA DENOMINATIONS

1	2	3	4	5	6	7	8
R0.01	R0.02	R0.05	R0.10	R0.20	R1	R2	R5
R0.05	R0.10	R0.25	R0.50	R1	R5	R10	R25
R0.10	R0.20	R0.50	R1	R2	R10	R20	R50
R0.50	R1	R2.50	R5	R10	R50	R100	R250
R1	R2	R5	R10	R20	R100	R200	R500

EU DENOMINATIONS

1	2	3	4	5	6	7	8
€0.01	€0.02	€0.05	€0.10	€0.20	€1	€2	€5
€0.05	€0.10	€0.25	€0.50	€1	€5	€10	€25
€0.10	€0.20	€0.50	€1	€2	€10	€20	€50
€0.50	€1	€2.50	€5	€10	€50	€100	€250
€1	€2	€5	€10	€20	€100	€200	€500

BET CONFIGURATIONS

1, 2, 3, 4, 5
1, 2, 3, 5, 8
1, 2, 3, 5, 10
1, 2, 5, 10, 20

MIN/MAX BET & Cost to Cover

MIN BET	MAX BET	Cost to Cover	Denomination
80	1600	80	Denomination 1, 2
40	800	40	Denomination 3, 4, 5
8	160	8	Denomination 6, 7, 8

(Depends on the above Bet Configurations)



FREE GAMES FEATURE

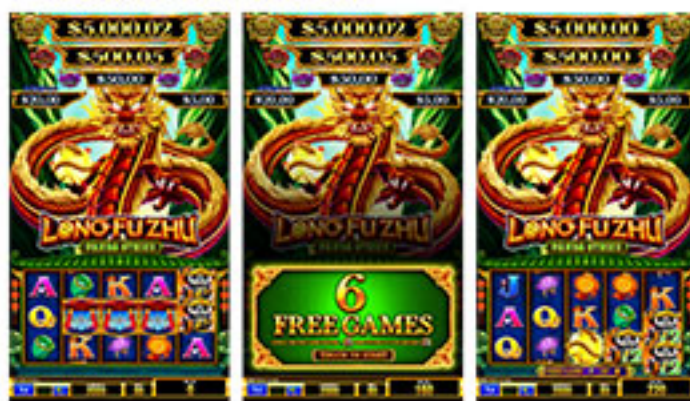

Any 3 appearing on reels 2, 3 and 4 trigger the FREE GAMES FEATURE with 6 free games. During the FREE GAMES FEATURE, substituting in a win becomes . The sum of multipliers from every that substitutes in a win multiplies the pay for that win. FREE GAMES FEATURE can be triggered again during the FREE GAMES FEATURE. FREE GAMES FEATURE starts after the DRAGON ORB FEATURE ends if triggered in the same game. If triggered in the same game, the FREE GAMES FEATURE starts after the DRAGON ORB FEATURE ends.

DRAGON ORB FEATURE



Any 6 or more appearing in a bought game or free game trigger the DRAGON ORB FEATURE. When DRAGON ORB FEATURE is triggered, 3 free spins are awarded. During the DRAGON ORB FEATURE, each symbol position becomes an individual spinning bonus reel.

Before the DRAGON ORB FEATURE starts, all reels are expanded upward 1 row of symbols and reel 5 is locked. In each free spin, reel 5 is locked if no new appearing on the reels. At the start of DRAGON ORB FEATURE, only 6 appear on random symbol positions on reels 1, 2, 3 and 4 and are held in the position for the duration of the DRAGON ORB FEATURE. In each free spin, any newly appearing unlock reel 5 for that spin only. Any newly appearing in a free spin unlocks the reel 5, and resets the number of remaining free spins to 3 and is held in position until the DRAGON ORB FEATURE ends.

PRIZES	ACTION PRIZE
MULTIPLIER x2, x3 or x5	Each prize displayed on held appearing on the same row in which the MULTIPLIER appears is being multiplied by that MULTIPLIER.
PRIZE AMOUNT (50 LINES) each equal to 5, 40, 80, 160, 100, 200 or 250 credits multiplied by bet multiplier as displayed	Each prize displayed on held appearing on the same row in which the PRIZE AMOUNT appears is increased by that PRIZE AMOUNT.
PRIZE AMOUNT (25 LINES) each equal to 5, 20, 40, 80, 70, 100 or 125 credits multiplied by bet multiplier as displayed	Each prize displayed on held appearing on the same row in which the PRIZE AMOUNT appears is increased by that PRIZE AMOUNT.
PRIZE AMOUNT (5 LINES) each equal to 5, 4, 8, 8, 15, 15, 25 or 25 credits multiplied by bet multiplier as displayed	Each prize displayed on held appearing on the same row in which the PRIZE AMOUNT appears is increased by that PRIZE AMOUNT.
BONUS x2, x3 or x5	Each prize displayed on held appearing on the same row in which the BONUS appears is increased by that BONUS.

When the reel 5 unlocks, it will spin automatically and each symbol position displayed one of the available prizes. DRAGON ORB FEATURE ends after all awarded free spins have been played or if appear in all 16 symbol positions on reels 1, 2, 3 and 4.



MYSTERY JACKPOT AWARD

There is a chance that the GRAND JACKPOT is randomly won in bought games except when FREE GAMES FEATURE or DRAGON ORB FEATURE is triggered.

XINYUNQIU™

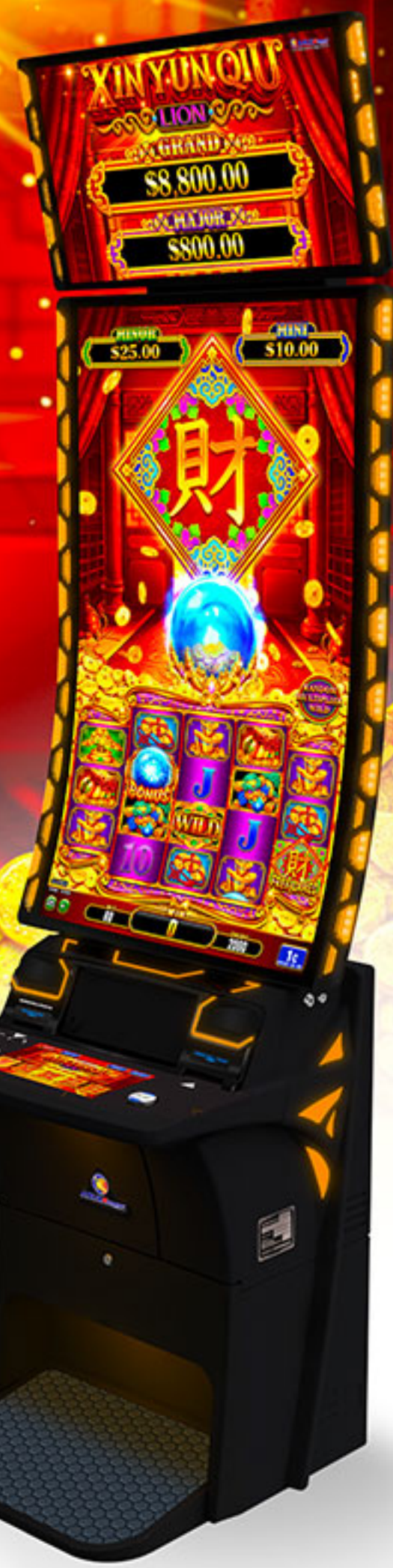

The powerful orb
brings extraordinary
fortunes!

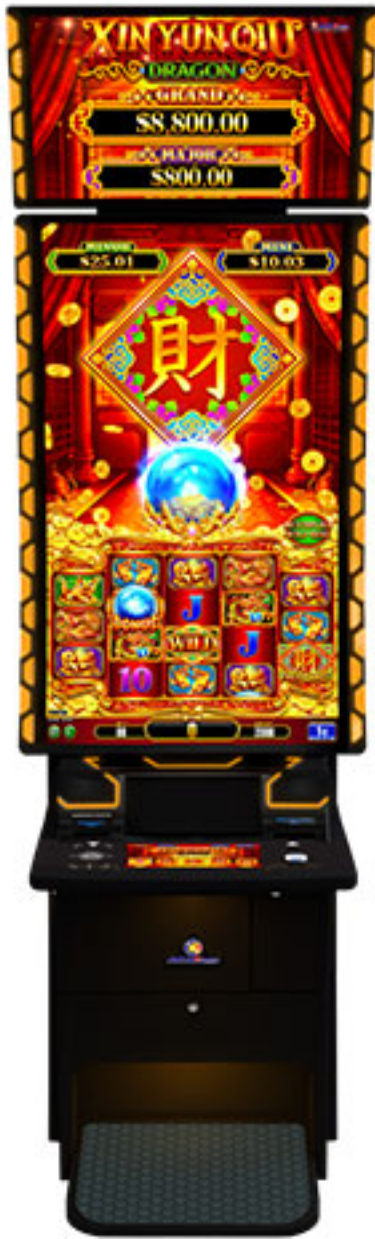

Also available in other Cabinets



TYPE OF PRODUCT

LINK / SAP

REEL CONFIGURATION

5-Reel 3-4-4-4-3-Row Video Slot

PAYLINES

32 Lines

DENOMINATIONS

SA R0.10

EU €0.01

BET CONFIGURATIONS

1, 2, 3, 4, 5, 6, 7, 8, 9, 10

MIN/MAX BET & Cost to Cover

MIN BET	MAX BET	Cost to Cover
88	880	88

(Depends on the above Bet Configurations)

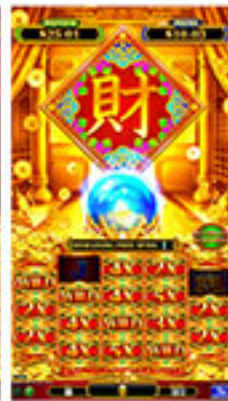

WILD HOLD FEATURE

3 scattered Wild appearing on reels 2, 3 and 4 trigger WILD HOLD FEATURE with 6 free spins.

Reels that triggered WILD HOLD FEATURE are held during the entirety of WILD HOLD FEATURE. Similarly, when WILD HOLD FEATURE triggered inside JACKPOT FEATURE, reels that triggered the JACKPOT FEATURE will use.

Wild symbol change to WILD after reel stop are held until all free spins have been awarded.

The sum of multipliers from every Wild / Wild / Wild / Wild / Wild that substitutes in a win multiplies the pay for that win. No wins for any combination during the free spins. All wins for WILD HOLD FEATURE are determined after the last free spin. However during JACKPOT FEATURE any coinciding win will be award first before proceeding to WILD HOLD FEATURE. WILD HOLD FEATURE start after the JACKPOT FEATURE ends if triggered in the same bought game.

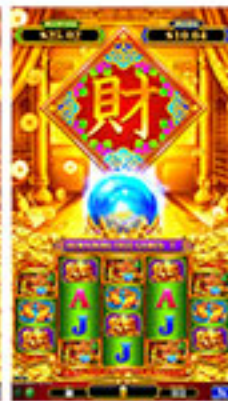
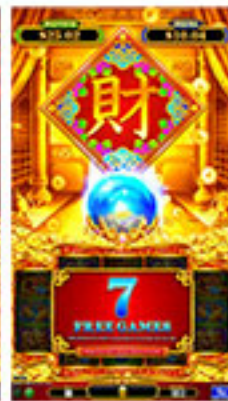

FREE GAMES FEATURE

3 Wild on reels 1, 3 and 5 trigger 7 FREE GAMES. FREE GAMES start after the JACKPOT FEATURE end if triggered in the same bought game. Bet Multiplier during the FREE GAME is same as the game that triggered the FREE GAME.

RANDOM WILD REEL

There is a chance that Wild change to Wild / Wild / Wild or Wild after reel stop. The sum of multipliers from every Wild / Wild / Wild / Wild that substitutes in a win multiplies the pay for that win.



JACKPOT FEATURE

There is a chance that the JACKPOT FEATURE may be triggered when 1 or more Wild appear in bought games only. In the JACKPOT FEATURE, there are 4 types of jackpot and WILD HOLD BONUS symbols hidden behind 15 icons. Select an icon until 3 matching symbol corresponding to JACKPOT or WILD HOLD BONUS are revealed.

When 3 matching jackpot symbol has been revealed, the corresponding JACKPOT is won and JACKPOT FEATURE ends. However when 3 matching Bonus has been revealed, proceed to WILD HOLD FEATURE and JACKPOT FEATURE ends. The chances of revealing each jackpot or Bonus icons are not equal.



MYSTERY CREDIT AWARD

There is a chance that the MYSTERY CREDIT AWARD may occur in bought games only when Wild is not stopped.

MYSTERY CREDIT AWARD is 15,000 credits, and multiplied by bet multiplier as displayed are awarded.

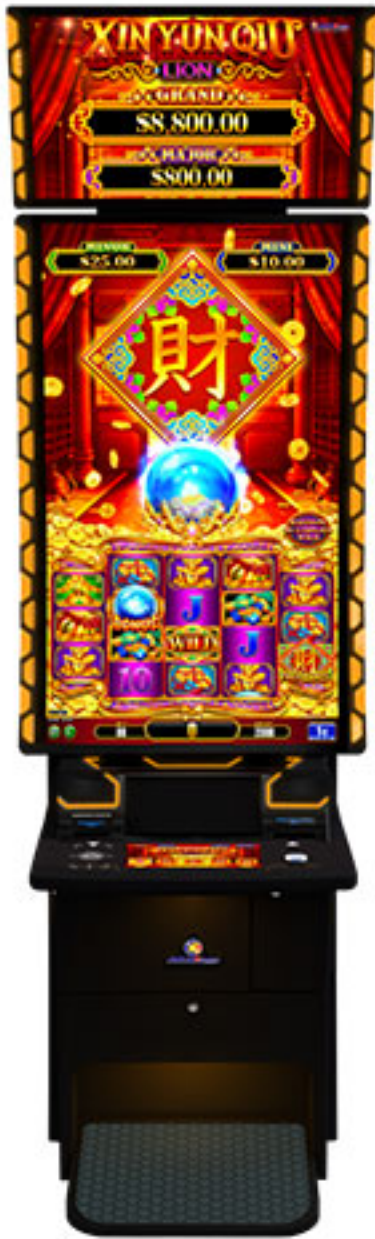

Also available in other Cabinets



TYPE OF PRODUCT

LINK / SAP

REEL CONFIGURATION

5-Reel 3-4-4-4-3-Row Video Slot

PAYLINES

32 Lines

DENOMINATIONS

SA R0.10

EU €0.01

BET CONFIGURATIONS

1, 2, 3, 4, 5, 6, 7, 8, 9, 10

MIN/MAX BET & Cost to Cover

MIN BET	MAX BET	Cost to Cover
88	880	88

(Depends on the above Bet Configurations)



WILD HOLD FEATURE

3 scattered appearing on reels 2, 3 and 4 trigger WILD HOLD FEATURE with 6 free spins.

Reels that triggered WILD HOLD FEATURE are held during the entirety of WILD HOLD FEATURE. Similarly, when WILD HOLD FEATURE triggered inside JACKPOT FEATURE, reels that triggered the JACKPOT FEATURE will use.

symbol change to WILD after reel stop are held until all free spins have been awarded.

The sum of multipliers from every / / / / that substitutes in a win multiplies the pay for that win. No wins for any combination during the free spins. All wins for WILD HOLD FEATURE are determined after the last free spin. However during JACKPOT FEATURE any coinciding win will be award first before proceeding to WILD HOLD FEATURE. WILD HOLD FEATURE start after the JACKPOT FEATURE ends if triggered in the same bought game.



FREE GAMES FEATURE

3 on reels 1, 3 and 5 trigger 7 FREE GAMES. FREE GAMES start after the JACKPOT FEATURE end if triggered in the same bought game. Bet Multiplier during the FREE GAME is same as the game that triggered the FREE GAME.

EXTRA RANDOM WILD

During reel spin, or may randomly add on the reel. The sum of multipliers from every / that substitutes in a win multiplies the pay for that win.



JACKPOT FEATURE

There is a chance that the JACKPOT FEATURE may be triggered when 1 or more appear in bought games only. In the JACKPOT FEATURE, there are 4 types of jackpot and WILD HOLD BONUS symbols hidden behind 15 icons. Select an icon until 3 matching symbol corresponding to JACKPOT or WILD HOLD BONUS are revealed.

When 3 matching jackpot symbol has been revealed, the corresponding JACKPOT is won and JACKPOT FEATURE ends. However when 3 matching has been revealed, proceed to WILD HOLD FEATURE and JACKPOT FEATURE ends. The chances of revealing each jackpot or Bonus icons are not equal.



MYSTERY CREDIT AWARD

There is a chance that the MYSTERY CREDIT AWARD may occur in bought games only when is not stopped.

MYSTERY CREDIT AWARD is 15,000 credits, and multiplied by bet multiplier as displayed are awarded.

BINGO JACKPOT™



The thrill
of the bingo game
enhanced with additional
exciting features!

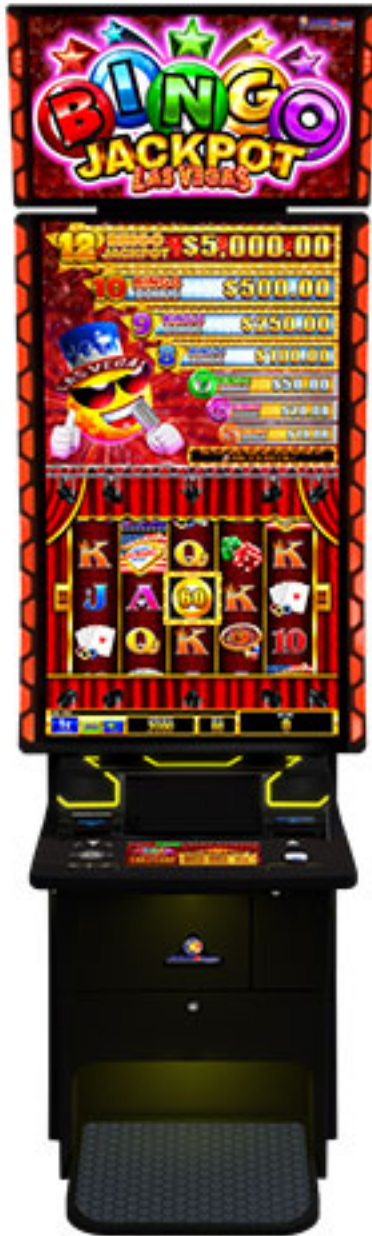

Also available in other Cabinets



TYPE OF PRODUCT

[LINK](#) / [SAP](#)

REEL CONFIGURATION

5-Reel 3-Row Video Slot
(Up to 5-Reel 5-Rows during the Bingo Collect Feature)

PAYLINES

50 Lines

DENOMINATIONS

SA R0.10

EU €0.01

BET CONFIGURATIONS

- 1, 2, 3, 4, 5
- 1, 2, 3, 4, 6
- 1, 2, 3, 4, 8
- 1, 2, 3, 5, 8
- 1, 2, 3, 5, 10
- 1, 2, 3, 6, 10

MIN/MAX BET & Cost to Cover

MIN BET	MAX BET	Cost to Cover
50	1000	50

(Depends on the above Bet Configurations)



FREE GAMES FEATURE



Any 3 or more trigger FREE GAMES FEATURE with 6 free games.

Different reels are used during the FREE GAMES FEATURE. FREE GAMES FEATURE can be triggered again during the FREE GAMES FEATURE.

FREE GAMES FEATURE starts after COLLECT FEATURE or BINGO COLLECT FEATURE ends if triggered in the same game.

COLLECT FEATURE



In bought games and FREE GAMES FEATURE, 6 or more prize symbols trigger COLLECT FEATURE.

However when appears in center position of reel 3, all prize shown in the reel will be awarded first before COLLECT FEATURE start. Any prize symbols appearing in the game that trigger the COLLECT FEATURE are held in position for the duration of the COLLECT FEATURE.

Each symbol position becomes an individual spinning bonus reel during the COLLECT FEATURE.

When the COLLECT FEATURE is triggered, 3 free spins are awarded. Each newly appearing prize symbol in a free spin resets the number of remaining free spins to 3 and is held in position until the COLLECT FEATURE ends.

During the COLLECT FEATURE, when appears on the center position of reel 3 BINGO COLLECT FEATURE is triggered. COLLECT FEATURE ends after all awarded free spins have been played or if BINGO COLLECT FEATURE is triggered.

BINGO COLLECT FEATURE



During base game and FREE GAME FEATURE, 5 or more prize symbol with appears on the center position of reel 3 triggers BINGO COLLECT FEATURE.

All prize symbol appearing in the game that triggers the BINGO COLLECT FEATURE are held in position for the duration of the BINGO COLLECT FEATURE.

Any newly appearing prize symbol in a free spin resets the number of remaining free spins to 3 and is held in position until the BINGO COLLECT FEATURE ends.

When the BINGO COLLECT FEATURE is triggered, 3 free spins are awarded. All reels are expanded to 5 symbol positions during the BINGO COLLECT FEATURE.

Each symbol position becomes an individual spinning bonus reel during the BINGO COLLECT FEATURE.

BINGO LINE wins are only paid at the end of the BINGO COLLECT FEATURE, with the highest BINGO LINE wins paid only. BINGO COLLECT FEATURE ends after all awarded free spins have been played or if BINGO LINE 12 is formed.



Also available in other Cabinets



TYPE OF PRODUCT

[LINK](#) / [SAP](#)

REEL CONFIGURATION

5-Reel 3-Row Video Slot
(Up to 5-Reel 5-Rows during the Bingo Collect Feature)

PAYLINES

50 Lines

DENOMINATIONS

SA R0.10

EU €0.01

BET CONFIGURATIONS

- 1, 2, 3, 4, 5
- 1, 2, 3, 4, 6
- 1, 2, 3, 4, 8
- 1, 2, 3, 5, 8
- 1, 2, 3, 5, 10
- 1, 2, 3, 6, 10

MIN/MAX BET & Cost to Cover

MIN BET	MAX BET	Cost to Cover
50	1000	50

(Depends on the above Bet Configurations)



FREE GAMES FEATURE



Any 3 or more trigger FREE GAMES FEATURE with 6 free games.

Different reels are used during the FREE GAMES FEATURE. FREE GAMES FEATURE can be triggered again during the FREE GAMES FEATURE.

FREE GAMES FEATURE starts after COLLECT FEATURE or BINGO COLLECT FEATURE ends if triggered in the same game.

COLLECT FEATURE



In bought games and FREE GAMES FEATURE, 6 or more prize symbols trigger COLLECT FEATURE.

However when appears in center position of reel 3, all prize shown in the reel will be awarded first before COLLECT FEATURE start. Any prize symbols appearing in the game that trigger the COLLECT FEATURE are held in position for the duration of the COLLECT FEATURE.

Each symbol position becomes an individual spinning bonus reel during the COLLECT FEATURE.

When the COLLECT FEATURE is triggered, 3 free spins are awarded. Each newly appearing prize symbol in a free spin resets the number of remaining free spins to 3 and is held in position until the COLLECT FEATURE ends.

During the COLLECT FEATURE, when appears on the center position of reel 3 BINGO COLLECT FEATURE is triggered. COLLECT FEATURE ends after all awarded free spins have been played or if BINGO COLLECT FEATURE is triggered.

BINGO COLLECT FEATURE



During base game and FREE GAME FEATURE, 5 or more prize symbol with appears on the center position of reel 3 triggers BINGO COLLECT FEATURE.

All prize symbol appearing in the game that triggers the BINGO COLLECT FEATURE are held in position for the duration of the BINGO COLLECT FEATURE.

Any newly appearing prize symbol in a free spin resets the number of remaining free spins to 3 and is held in position until the BINGO COLLECT FEATURE ends.

When the BINGO COLLECT FEATURE is triggered, 3 free spins are awarded. All reels are expanded to 5 symbol positions during the BINGO COLLECT FEATURE.

Each symbol position becomes an individual spinning bonus reel during the BINGO COLLECT FEATURE.

BINGO LINE wins are only paid at the end of the BINGO COLLECT FEATURE, with the highest BINGO LINE wins paid only. BINGO COLLECT FEATURE ends after all awarded free spins have been played or if BINGO LINE 12 is formed.

POWER TOWER™

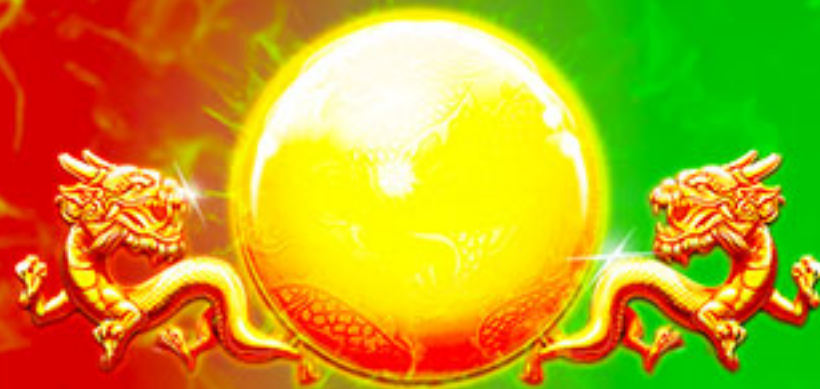

Play higher and
unlock your chances
for bigger fortunes
with special symbols!



HIGHER BETS HAVE BETTER LOCK IN FEATURE BONUS CHANCE

ORB POWER FEATURE



Any 6 or more scattered or a combination of and triggers the ORB POWER FEATURE.

During ORB POWER FEATURE, all symbol positions become individual spinning bonus reels.

Any that triggers ORB POWER FEATURE or appear during ORB POWER FEATURE are held for the duration of ORB POWER FEATURE. The symbols will be removed once the feature begins.

When ORB POWER FEATURE is triggered, 5 free spins are awarded. 1 of the following available prizes is displayed on each :

- Prize Amount
- Bonus: MINOR BONUS or MINI BONUS
- Jackpot: GRAND JACKPOT or MAJOR JACKPOT

and may also be awarded during ORB POWER FEATURE.

: Unlocks 1 reel window on the reel directly above where the appears.
(All prizes in the unlocked reel window will be awarded after the ORB POWER FEATURE)

: Awards 1 additional spin.

Also available in other Cabinets



TYPE OF PRODUCT

[LINK](#) / [SAP](#)

REEL CONFIGURATION

5-Reel 4-4-5-4-4 Row Video Slot

PAYLINES

50 Lines

DENOMINATIONS

SA R0.10

EU €0.01

BET CONFIGURATIONS

1, 2, 3, 4, 5

1, 2, 3, 5, 10

MIN/MAX BET & Cost to Cover

MIN BET	MAX BET	Cost to Cover
75	975	175

(Depends on the above Bet Configurations)

LOCK IN FEATURE



There is a chance that LOCK IN FEATURE may be triggered when any or appears on a reel. During bought games, when or appears on a reel and triggers the LOCK IN FEATURE, the corresponding upper reel will be unlocked.

When LOCK IN FEATURE is triggered, 5 free spins are awarded.

All prizes in the unlocked reel windows will be awarded after the LOCK IN FEATURE has completed. Any unlocked bonus symbol reel is locked again after LOCK IN FEATURE ends.



HIGHER BETS HAVE BETTER LOCK IN FEATURE BONUS CHANCE

Also available in other Cabinets



TYPE OF PRODUCT

LINK / SAP

REEL CONFIGURATION

5-Reel 4-4-5-4-4 Row Video Slot

PAYLINES

50 Lines

DENOMINATIONS

SA R0.10

EU €0.01

BET CONFIGURATIONS

1, 2, 3, 4, 5

1, 2, 3, 5, 10

MIN/MAX BET & Cost to Cover

MIN BET	MAX BET	Cost to Cover
75	975	175

(Depends on the above Bet Configurations)

ORB POWER FEATURE

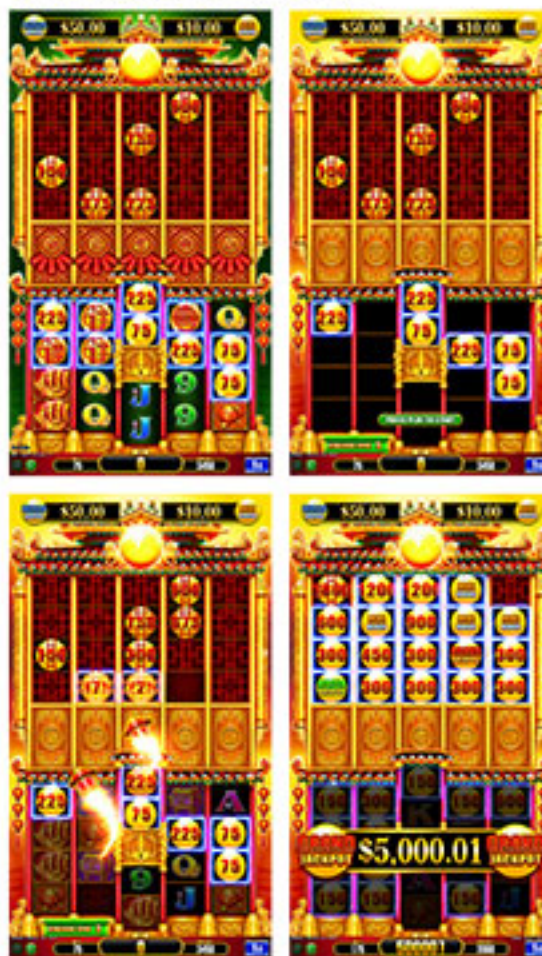

Any 6 or more scattered or a combination of and triggers the ORB POWER FEATURE.

During ORB POWER FEATURE, all symbol positions become individual spinning bonus reels.

Any that triggers ORB POWER FEATURE or appear during ORB POWER FEATURE are held for the duration of ORB POWER FEATURE. The symbols will be removed once the feature begins.

When ORB POWER FEATURE is triggered, 5 free spins are awarded. 1 of the following available prizes is displayed on each :

- Prize Amount
- Bonus: MINOR BONUS or MINI BONUS
- Jackpot: GRAND JACKPOT or MAJOR JACKPOT

and may also be awarded during ORB POWER FEATURE.

: Unlocks 1 reel window on the reel directly above where the appears.
(All prizes in the unlocked reel window will be awarded after the ORB POWER FEATURE)

: Awards 1 additional spin.

LOCK IN FEATURE



There is a chance that LOCK IN FEATURE may be triggered when any or appears on a reel. During bought games, when or appears on a reel and triggers the LOCK IN FEATURE, the corresponding upper reel will be unlocked.

When LOCK IN FEATURE is triggered, 5 free spins are awarded.

All prizes in the unlocked reel windows will be awarded after the LOCK IN FEATURE has completed.

Any unlocked bonus symbol reel is locked again after LOCK IN FEATURE ends.

DOUBLE FIRESTORM™



**Special fireball
symbols unlocking rows
and awarding
blazing prizes!**



Also available in other Cabinets



TYPE OF PRODUCT

[LINK](#) / [SAP](#)

REEL CONFIGURATION

5-Reel 4-Row Video Slot
(Up to 10 rows during RISING FIRE)

PAYLINES

50 Lines

SA DENOMINATIONS

1	2	3	4	5
R0.01	R0.02	R0.05	R0.10	R0.20
R0.05	R0.10	R0.25	R0.50	R1
R0.10	R0.20	R0.50	R1	R2
R0.50	R1	R2.50	R5	R10
R1	R2	R5	R10	R20

EU DENOMINATIONS

1	2	3	4	5
€0.01	€0.02	€0.05	€0.10	€0.20
€0.05	€0.10	€0.25	€0.50	€1
€0.10	€0.20	€0.50	€1	€2
€0.50	€1	€2.50	€5	€10
€1	€2	€5	€10	€20

BET CONFIGURATIONS

1, 2, 3, 4, 5, 8, 10

MIN/MAX BET & Cost to Cover

MIN BET	MAX BET	Cost to Cover	BET LEVEL
75	975	75	Bet Level 1
85	1075	85	Bet Level 2

(Depends on the above Bet Configurations)



PLAY HIGHER BET TO BOOST THE PRIZES!

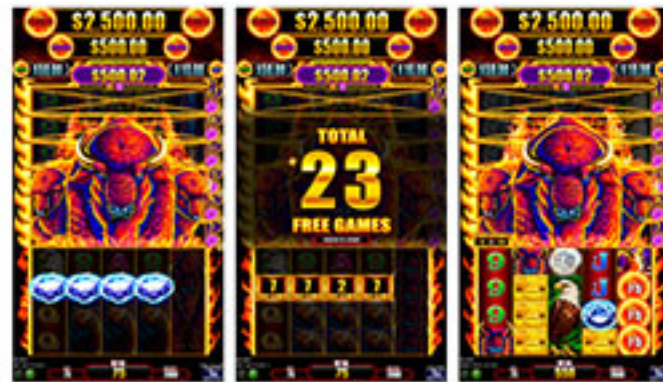

FREE GAMES FEATURE

appearing on 3 or more consecutive reels beginning with the leftmost reel trigger the FREE GAMES FEATURE. The sum of the numbers that appeared is awarded as FREE GAMES in the FREE GAMES FEATURE.

When the FREE GAMES FEATURE is triggered, a number appears on each that was involved in triggering the feature. 1, 2, 3, 5, 7 or 10 free games are awarded for each . If RISING FIRE is triggered during the FREE GAMES FEATURE, any remaining free games resume after RISING FIRE ends.

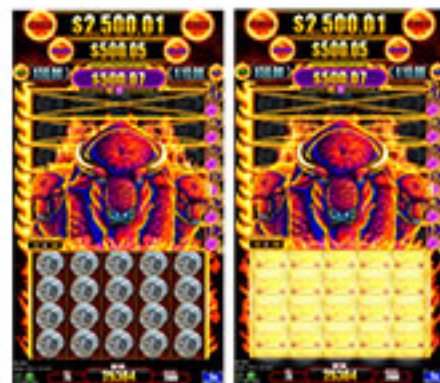

MYSTERY SYMBOL

During bought games, appearing on the reels changes to after all reels finish spinning. During FREE GAMES FEATURE, appearing on the reels changes to or after all reels finish spinning. All appearing in the same game randomly change to the same symbol. If appears, wins are determined after finishes changing.

IMPROVED JACKPOTS PER PLAY

Reels containing improved jackpots symbols can be played. When Game is played with Bet Level 2, the jackpot prize and bonus prize changes as described below:

- and : Initial value is doubled as displayed.
- and : Value is doubled as displayed



RISING FIRE

Any 6 or more in a bought game or free game trigger RISING FIRE. During RISING FIRE, all symbol positions become individual spinning bonus reels. Any that trigger RISING FIRE or appear during RISING FIRE are held for the duration of RISING FIRE. Any that trigger RISING FIRE or appear during RISING FIRE decrease the remaining number of needed to unlock bonus symbol rows and decrease the number of remaining needed to win the UP UP JACKPOT. When RISING FIRE is triggered, 3 free spins are awarded. Each newly appearing in a free spin resets the number of remaining free spins to 3. RISING FIRE ends after all awarded free spins have been played or if fills every symbol position. Any unlocked bonus symbol row is locked again after RISING FIRE ends. The number of remaining required to unlock any bonus symbol row is reset after RISING FIRE ends. The number of remaining required to win the UP UP JACKPOT is reset after RISING FIRE ends.

JACKPOT SURPRISE



There is a chance that 1 JACKPOT is randomly won in bought games except when FREE GAMES FEATURE or RISING FIRE is triggered.

NORMAL BET

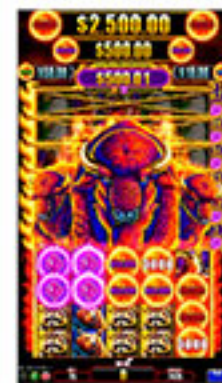

HIGHER BET



PLAY HIGHER BET FOR INCREASED JACKPOTS AND BONUSES!

POW POW PANDA™

**BOOST
BONUS**

**RISING
BONUS**



**Discover your
chance for explosive
wins as the panda
lights firecrackers
for a shot at multiple
feature wins!**



Also available in other Cabinets



REEL CONFIGURATION

5-Reel 3-Row Video Slot
5-Reel 5-Row Video Slot (During RISING BONUS FEATURE and BOOST & RISING BONUS FEATURE)

PAYLINES

20 Lines (Bet Level 1)
30 Lines (Bet Level 2)
40 Lines (Bet Level 3) (During RISING BONUS FEATURE and BOOST & RISING BONUS FEATURE add 10 Lines)

SA DENOMINATIONS

1	2	3	4
R0.01	R0.02	R0.05	R0.10
R0.02	R0.05	R0.10	R0.20
R0.05	R0.10	R0.20	R0.50
R0.10	R0.20	R0.50	R1
R0.20	R0.50	R1	R2
R0.50	R1	R2	R5
R1	R2	R5	R10

EU DENOMINATIONS

1	2	3	4
€0.01	€0.02	€0.05	€0.10
€0.02	€0.05	€0.10	€0.20
€0.05	€0.10	€0.20	€0.50
€0.10	€0.20	€0.50	€1
€0.20	€0.50	€1	€2
€0.50	€1	€2	€5
€1	€2	€5	€10

BET CONFIGURATIONS

1, 2, 3, 4, 5, 6, 7, 8, 9, 10

MIN/MAX BET & Cost to Cover

MIN BET	MAX BET	Cost to Cover	BET LEVEL
38	380	38	Bet Level 1
58	580	58	Bet Level 2
88	880	88	Bet Level 3

(Depends on the above Bet Configurations)



FREE GAMES FEATURE

When symbol appears on the center position of reel 3, there's a chance that FREE GAMES FEATURE will be triggered. A FIRECRACKER will explode and award the following: BOOST BONUS, RISING BONUS, and BOOST & RISING BONUS.

BOOST BONUS FEATURE



If the red firecracker explode, it triggers 6 FREE GAMES of BOOST BONUS FEATURE. Before BOOST BONUS FEATURE start, the state of the firecracker on the upper left side of the reels is reset. During free games of BOOST BONUS FEATURE, the symbol is always hold on the center position of reel 3.

Different reels are used during BOOST BONUS FEATURE.

If you trigger both free games of BOOST BONUS FEATURE and RISING BONUS FEATURE in the same game, free games of BOOST & RISING BONUS FEATURE will start after free games of BOOST BONUS FEATURE end.

If you trigger free games of RISING BONUS FEATURE in the same game, it will start after free games of BOOST BONUS FEATURE end. If you win free games of BOOST BONUS FEATURE in the same game, an additional 6 free games added.

RISING BONUS FEATURE

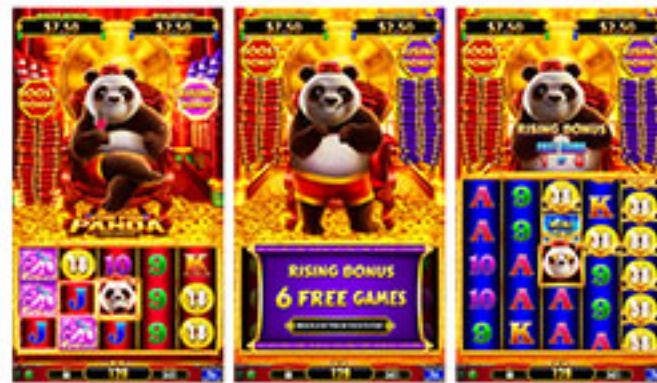

If the purple firecracker explode, it triggers 6 FREE GAMES of RISING BONUS FEATURE. Before RISING BONUS FEATURE start, the state of the firecracker on the upper right side of the reels is reset. At the start of RISING BONUS FEATURE, it would be 5 reels by 5 rows.

During RISING BONUS FEATURE, it will be 50 lines.

During free games of RISING BONUS FEATURE, the symbol is always hold on the center position of reel 3.

Different reels are used during RISING BONUS FEATURE.

If you trigger both free games of BOOST BONUS FEATURE and RISING BONUS FEATURE in the same game, free games of BOOST & RISING BONUS FEATURE will start after free games of RISING BONUS FEATURE end. If you win free games of RISING BONUS FEATURE in the same game, an additional 6 free games added. If you trigger free games of BOOST BONUS FEATURE in the same game, it will start after free games of RISING BONUS FEATURE end.

BOOST & RISING BONUS FEATURE



If the red and purple firecracker explode together, it triggers 12 FREE GAMES of BOOST & RISING BONUS FEATURE.

Before BOOST & RISING BONUS FEATURE start, the state of the firecracker on the upper left and right side of the reels is reset. At the start of BOOST & RISING BONUS FEATURE, it would be 5 reels by 5 rows. During BOOST & RISING BONUS FEATURE, it will be 50 lines.

During free games of BOOST & RISING BONUS FEATURE, the symbol is always hold on the center position of reel 3. Different reels are used during BOOST & RISING BONUS FEATURE.

If you win free games of BOOST & RISING BONUS FEATURE in the same game, an additional 12 free games added. If you trigger free games of RISING BONUS FEATURE in the same game, it will start after free games of BOOST & RISING BONUS FEATURE end. If you trigger free games of BOOST BONUS FEATURE in the same game, it will start after free games of BOOST & RISING BONUS FEATURE end.



Also available in other Cabinets



REEL CONFIGURATION

5-Reel 3-Row Video Slot
5-Reel 5-Row Video Slot (During RISING BONUS FEATURE and BOOST & RISING BONUS FEATURE)

PAYLINES

20 Lines (Bet Level 1)
30 Lines (Bet Level 2)
40 Lines (Bet Level 3) (During RISING BONUS FEATURE and BOOST & RISING BONUS FEATURE add 10 Lines)

SA DENOMINATIONS

1	2	3	4
R0.01	R0.02	R0.05	R0.10
R0.02	R0.05	R0.10	R0.20
R0.05	R0.10	R0.20	R0.50
R0.10	R0.20	R0.50	R1
R0.20	R0.50	R1	R2
R0.50	R1	R2	R5
R1	R2	R5	R10

EU DENOMINATIONS

1	2	3	4
€0.01	€0.02	€0.05	€0.10
€0.02	€0.05	€0.10	€0.20
€0.05	€0.10	€0.20	€0.50
€0.10	€0.20	€0.50	€1
€0.20	€0.50	€1	€2
€0.50	€1	€2	€5
€1	€2	€5	€10

BET CONFIGURATIONS

1, 2, 3, 4, 5, 6, 7, 8, 9, 10

MIN/MAX BET & Cost to Cover

MIN BET	MAX BET	Cost to Cover	BET LEVEL
38	380	38	Bet Level 1
58	580	58	Bet Level 2
88	880	88	Bet Level 3

(Depends on the above Bet Configurations)



FREE GAMES FEATURE

When symbol appears on the center position of reel 3, there's a chance that FREE GAMES FEATURE will be triggered. A FIRECRACKER will explode and award the following: BOOST BONUS, RISING BONUS, and BOOST & RISING BONUS.

BOOST BONUS FEATURE

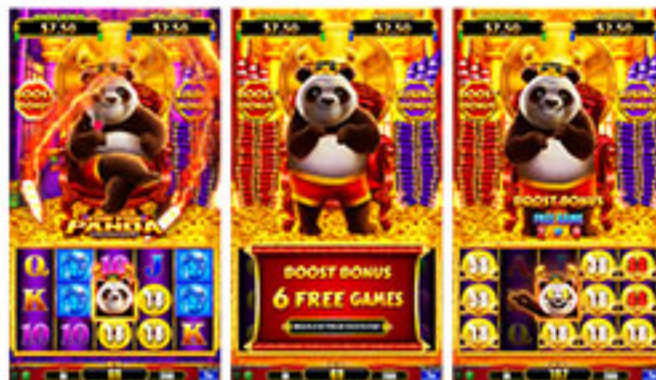

If the red firecracker explode, it triggers 6 FREE GAMES of BOOST BONUS FEATURE. Before BOOST BONUS FEATURE start, the state of the firecracker on the upper left side of the reels is reset.

During free games of BOOST BONUS FEATURE, the symbol appears more often on the center position of reel 3.

Different reels are used during BOOST BONUS FEATURE.

If you trigger both free games of BOOST BONUS FEATURE and RISING BONUS FEATURE in the same game, free games of BOOST & RISING BONUS FEATURE will start after free games of BOOST BONUS FEATURE end.

If you trigger free games of RISING BONUS FEATURE in the same game, it will start after free games of BOOST BONUS FEATURE end. If you win free games of BOOST BONUS FEATURE in the same game, an additional 6 free games added.

RISING BONUS FEATURE

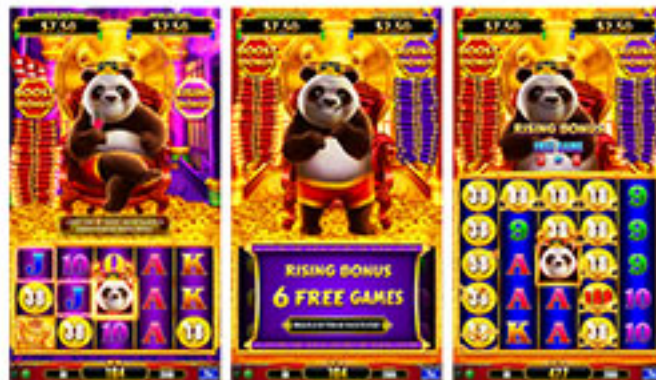

If the purple firecracker explode, it triggers 6 FREE GAMES of RISING BONUS FEATURE. Before RISING BONUS FEATURE start, the state of the firecracker on the upper right side of the reels is reset. At the start of RISING BONUS FEATURE, it would be 5 reels by 5 rows.

During RISING BONUS FEATURE, it will be 50 lines.

During free games of RISING BONUS FEATURE, the symbol appears more often on the center position of reel 3.

Different reels are used during RISING BONUS FEATURE.

If you trigger both free games of BOOST BONUS FEATURE and RISING BONUS FEATURE in the same game, free games of BOOST & RISING BONUS FEATURE will start after free games of RISING BONUS FEATURE end. If you win free games of RISING BONUS FEATURE in the same game, an additional 6 free games added. If you trigger free games of BOOST BONUS FEATURE in the same game, it will start after free games of RISING BONUS FEATURE end.

BOOST & RISING BONUS FEATURE



If the red and purple firecracker explode together, it triggers 12 FREE GAMES of BOOST & RISING BONUS FEATURE.

Before BOOST & RISING BONUS FEATURE start, the state of the firecracker on the upper left and right side of the reels is reset.

At the start of BOOST & RISING BONUS FEATURE, it would be 5 reels by 5 rows. During BOOST & RISING BONUS FEATURE, it will be 50 lines.

During free games of BOOST & RISING BONUS FEATURE, the symbol appears more often on the center position of reel 3.

Different reels are used during BOOST & RISING BONUS FEATURE.

If you win free games of BOOST & RISING BONUS FEATURE in the same game, an additional 12 free games added. If you trigger free games of RISING BONUS FEATURE in the same game, it will start after free games of BOOST & RISING BONUS FEATURE end. If you trigger free games of BOOST BONUS FEATURE in the same game, it will start after free games of BOOST & RISING BONUS FEATURE end.



New honeycomb LED (Details)



An LCD monitor with three 32-inch high definition monitor



New Face Design



MUSO™
TRIPLE-32HB

Being the only one of its kind: unlike anything else.

A stunning new honeycomb cabinet LED display to attract players.

Thoughtful touches to keep them comfortable.

All designed for an unparalleled gaming experience.

Stunning HD Graphics

Breathtakingly clear and bursting with rich colors displayed on three large **32-inch monitors**.

BUILT FOR EXCELLENCE

DIMENSION

Upright Height (Tower Light Included)
2365 mm (93.1 in)

Upright Height (Tower Light Excluded)
2271 mm (89.4 in)

Width
810 mm (31.9 in)

Depth
685.4 mm (27 in)

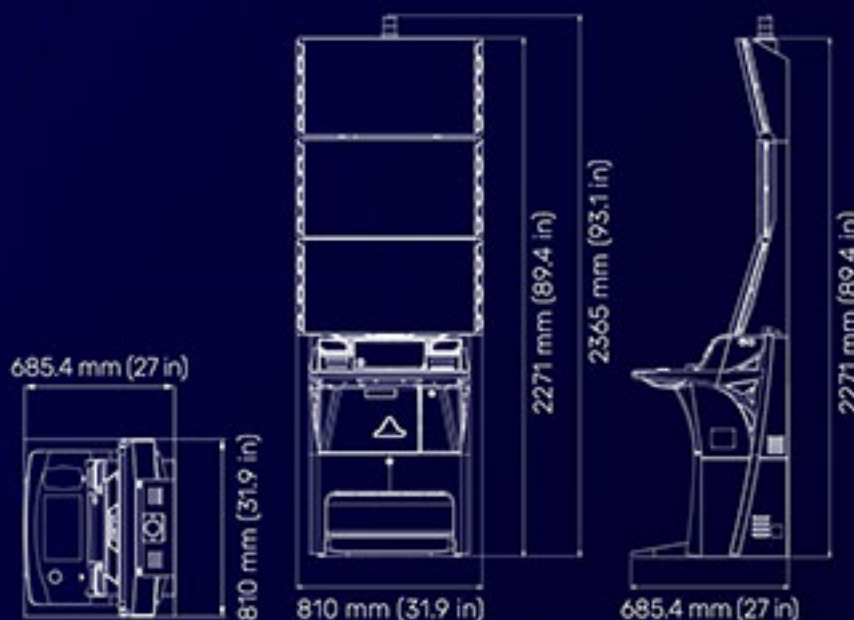

Please contact your Account Executive for more details.

sales@aruzeglobal.com

+1 702-781-8080

www.aruzeglobal.com

Follow us @AruzeGaming



Empire Technological Group Ltd dba
Aruze Gaming Global

TOMB TREASURE™





Also available in other Cabinet



TYPE OF PRODUCT

LINK / SAP

REEL CONFIGURATION

5-Reel 3-Row Video Slot

PAYLINES

10, 25, 50 Lines (Denomination 1, 2)
5, 10, 25 Lines (Denomination 3, 4, 5)
5 Lines (Denomination 6, 7, 8)

SA DENOMINATIONS

1	2	3	4	5	6	7	8
R0.01	R0.02	R0.05	R0.10	R0.20	R1	R2	R5
R0.05	R0.10	R0.25	R0.50	R1	R5	R10	R25
R0.10	R0.20	R0.50	R1	R2	R10	R20	R50
R0.50	R1	R2.50	R5	R10	R50	R100	R250
R1	R2	R5	R10	R20	R100	R200	R500

EU DENOMINATIONS

1	2	3	4	5	6	7	8
€0.01	€0.02	€0.05	€0.10	€0.20	€1	€2	€5
€0.05	€0.10	€0.25	€0.50	€1	€5	€10	€25
€0.10	€0.20	€0.50	€1	€2	€10	€20	€50
€0.50	€1	€2.50	€5	€10	€50	€100	€250
€1	€2	€5	€10	€20	€100	€200	€500

BET CONFIGURATIONS

1, 2, 3, 4, 5
1, 2, 3, 5, 8
1, 2, 3, 5, 10
1, 2, 5, 10, 20

MIN/MAX BET & Cost to Cover

MIN BET	MAX BET	Cost to Cover	Denomination
10	1000	10	Denomination 1, 2
5	500	5	Denomination 3, 4, 5
5	100	5	Denomination 6, 7, 8

(Depends on the above Bet Configurations)



FREE GAMES FEATURE



Any 3 appearing on reels 2, 3 and 4 trigger the FREE GAMES FEATURE with 8 free games.

Reels used during the FREE GAMES FEATURE contain a greater total number of .

FREE GAMES FEATURE can be triggered again during the FREE GAMES FEATURE.

FREE GAMES FEATURE starts after the PYRAMID FEATURE ends if triggered in the same game.

If PYRAMID FEATURE is triggered during the FREE GAMES FEATURE, any remaining free games resume after the PYRAMID FEATURE ends.

PYRAMID FEATURE



Any 6 or more trigger the PYRAMID FEATURE and are held in position on the reels for the duration of the PYRAMID FEATURE. PYRAMID FEATURE consists of 3 free spins.

During the PYRAMID FEATURE, each symbol position becomes an individual spinning bonus reel.

In the PYRAMID FEATURE, a prize map corresponding to the 15 symbol positions on the reels is displayed above the reels. Before the first free spin, each on the reels displays the prize from the corresponding location on the prize map.

While a is held on the reels, the prize in the corresponding location on the prize map is also held.

At the start of each free spin in PYRAMID FEATURE, displayed prizes are redetermined for prize map squares that do not contain a held prize.

Each new appearing in a free spin displays a prize value that it is the sum of all held prizes displayed on the prize map from the previous free spin within the same PYRAMID FEATURE only.

Each new appearing in a free spin resets the number of remaining free spins to 3 and is held in position for the duration of the PYRAMID FEATURE.

PYRAMID FEATURE ends after all awarded free spins have been played or if appear in all 15 symbol positions. All prizes on Pyramid symbols are won at the end of feature.

JACKPOT SURPRISE

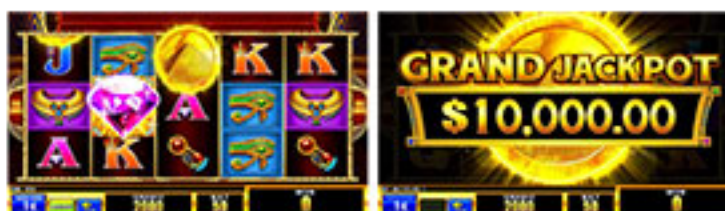

There is a chance that the GRAND JACKPOT is randomly won in bought games except when FREE GAMES FEATURE or PYRAMID FEATURE is triggered.



Also available in other Cabinet



TYPE OF PRODUCT

[LINK](#) / [SAP](#)

REEL CONFIGURATION

5-Reel 3-Row Video Slot

PAYLINES

10, 25, 50 Lines (Denomination 1, 2)
5, 10, 25 Lines (Denomination 3, 4, 5)
5 Lines (Denomination 6, 7, 8)

SA DENOMINATIONS

1	2	3	4	5	6	7	8
R0.01	R0.02	R0.05	R0.10	R0.20	R1	R2	R5
R0.05	R0.10	R0.25	R0.50	R1	R5	R10	R25
R0.10	R0.20	R0.50	R1	R2	R10	R20	R50
R0.50	R1	R2.50	R5	R10	R50	R100	R250
R1	R2	R5	R10	R20	R100	R200	R500

EU DENOMINATIONS

1	2	3	4	5	6	7	8
€0.01	€0.02	€0.05	€0.10	€0.20	€1	€2	€5
€0.05	€0.10	€0.25	€0.50	€1	€5	€10	€25
€0.10	€0.20	€0.50	€1	€2	€10	€20	€50
€0.50	€1	€2.50	€5	€10	€50	€100	€250
€1	€2	€5	€10	€20	€100	€200	€500

BET CONFIGURATIONS

1, 2, 3, 4, 5
1, 2, 3, 5, 8
1, 2, 3, 5, 10
1, 2, 5, 10, 20

MIN/MAX BET & Cost to Cover

MIN BET	MAX BET	Cost to Cover	Denomination
10	1000	10	Denomination 1, 2
5	500	5	Denomination 3, 4, 5
5	100	5	Denomination 6, 7, 8

(Depends on the above Bet Configurations)



FREE GAMES FEATURE

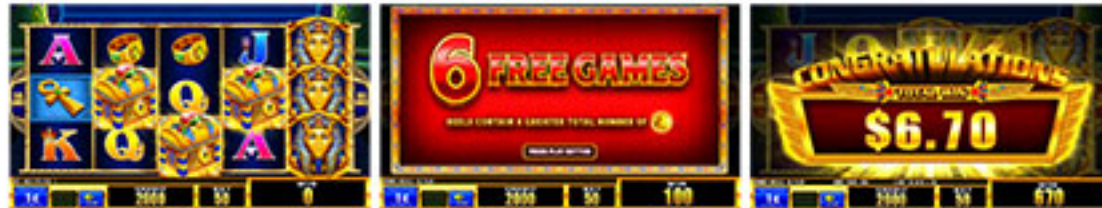

Any 3 appearing on reels 2, 3 and 4 trigger the FREE GAMES FEATURE with 6 free games. Reels used during the FREE GAMES FEATURE contain a greater total number of . FREE GAMES FEATURE can be triggered again during the FREE GAMES FEATURE. FREE GAMES FEATURE starts after the PYRAMID FEATURE ends if triggered in the same game. If PYRAMID FEATURE is triggered during the FREE GAMES FEATURE, any remaining free games resume after the PYRAMID FEATURE ends.

PYRAMID FEATURE



Any 6 or more trigger the PYRAMID FEATURE and are held in position on the reels for the duration of the PYRAMID FEATURE. PYRAMID FEATURE consists of 3 free spins. During the PYRAMID FEATURE, each symbol position becomes an individual spinning bonus reel. In the PYRAMID FEATURE, a prize map corresponding to the 15 symbol positions on the reels is displayed above the reels. Before the first free spin, each on the reels displays the prize from the corresponding location on the prize map. While a is held on the reels, the prize in the corresponding location on the prize map is also held. At the start of each free spin in PYRAMID FEATURE, displayed prizes are redetermined for prize map squares that do not contain a held prize. Each new appearing in a free spin displays a prize value that it is the sum of all held prizes displayed on the prize map from the previous free spin within the same PYRAMID FEATURE only. Each new appearing in a free spin resets the number of remaining free spins to 3 and is held in position for the duration of the PYRAMID FEATURE. PYRAMID FEATURE ends after all awarded free spins have been played or if appear in all 15 symbol positions. All prizes on Pyramid symbols are won at the end of feature.

JACKPOT SURPRISE



There is a chance that the GRAND JACKPOT is randomly won in bought games except when FREE GAMES FEATURE or PYRAMID FEATURE is triggered.



Also available in other Cabinet



TYPE OF PRODUCT

LINK / SAP

REEL CONFIGURATION

5-Reel 3-Row Video Slot

PAYLINES

10, 25, 50 Lines (Denomination 1, 2)
5, 10, 25 Lines (Denomination 3, 4, 5)
5 Lines (Denomination 6, 7, 8)

SA DENOMINATIONS

1	2	3	4	5	6	7	8
R0.01	R0.02	R0.05	R0.10	R0.20	R1	R2	R5
R0.05	R0.10	R0.25	R0.50	R1	R5	R10	R25
R0.10	R0.20	R0.50	R1	R2	R10	R20	R50
R0.50	R1	R2.50	R5	R10	R50	R100	R250
R1	R2	R5	R10	R20	R100	R200	R500

EU DENOMINATIONS

1	2	3	4	5	6	7	8
€0.01	€0.02	€0.05	€0.10	€0.20	€1	€2	€5
€0.05	€0.10	€0.25	€0.50	€1	€5	€10	€25
€0.10	€0.20	€0.50	€1	€2	€10	€20	€50
€0.50	€1	€2.50	€5	€10	€50	€100	€250
€1	€2	€5	€10	€20	€100	€200	€500

BET CONFIGURATIONS

1, 2, 3, 4, 5
1, 2, 3, 5, 8
1, 2, 3, 5, 10
1, 2, 5, 10, 20

MIN/MAX BET & Cost to Cover

MIN BET	MAX BET	Cost to Cover	Denomination
10	1000	10	Denomination 1, 2
5	500	5	Denomination 3, 4, 5
5	100	5	Denomination 6, 7, 8

(Depends on the above Bet Configurations)



FREE GAMES FEATURE



Any 3 appearing on reels 2, 3 and 4 trigger the FREE GAMES FEATURE with 8 free games. Reels used during the FREE GAMES FEATURE contain a greater total number of . FREE GAMES FEATURE can be triggered again during the FREE GAMES FEATURE. FREE GAMES FEATURE starts after the PYRAMID FEATURE ends if triggered in the same game. If PYRAMID FEATURE is triggered during the FREE GAMES FEATURE, any remaining free games resume after the PYRAMID FEATURE ends.

PYRAMID FEATURE



Any 6 or more trigger the PYRAMID FEATURE and are held in position on the reels for the duration of the PYRAMID FEATURE. PYRAMID FEATURE consists of 3 free spins. During the PYRAMID FEATURE, each symbol position becomes an individual spinning bonus reel. In the PYRAMID FEATURE, a prize map corresponding to the 15 symbol positions on the reels is displayed above the reels. Before the first free spin, each on the reels displays the prize from the corresponding location on the prize map. While a is held on the reels, the prize in the corresponding location on the prize map is also held. At the start of each free spin in PYRAMID FEATURE, displayed prizes are redetermined for prize map squares that do not contain a held prize. Each new appearing in a free spin displays a prize value that it is the sum of all held prizes displayed on the prize map from the previous free spin within the same PYRAMID FEATURE only. Each new appearing in a free spin resets the number of remaining free spins to 3 and is held in position for the duration of the PYRAMID FEATURE. PYRAMID FEATURE ends after all awarded free spins have been played or if appear in all 15 symbol positions. All prizes on Pyramid symbols are won at the end of feature.

JACKPOT SURPRISE



There is a chance that the GRAND JACKPOT is randomly won in bought games except when FREE GAMES FEATURE or PYRAMID FEATURE is triggered.

LIGHTNING ARROW™



Unleash the
arrow feature to
collect rewards!



Also available in other Cabinet



TYPE OF PRODUCT

[LINK](#) / [SAP](#)

REEL CONFIGURATION

5-Reel 3-Row Video Slot

PAYLINES

243 Ways

SA DENOMINATIONS

1	2	3	4	5	6	7
R0.01	R0.02	R0.05	R0.10	R0.20	R1	R2
R0.05	R0.10	R0.25	R0.50	R1	R5	R10
R0.10	R0.20	R0.50	R1	R2	R10	R20
R0.50	R1	R2.50	R5	R10	R50	R100
R1	R2	R5	R10	R20	R100	R200

EU DENOMINATIONS

1	2	3	4	5	6	7
€0.01	€0.02	€0.05	€0.10	€0.20	€1	€2
€0.05	€0.10	€0.25	€0.50	€1	€5	€10
€0.10	€0.20	€0.50	€1	€2	€10	€20
€0.50	€1	€2.50	€5	€10	€50	€100
€1	€2	€5	€10	€20	€100	€200

BET CONFIGURATIONS

- 1, 2, 3, 4, 5
- 1, 2, 3, 5, 8
- 1, 2, 3, 5, 10
- 1, 2, 5, 10, 20 (Disabled for Denomination 7)
- 1, 2

MIN/MAX BET & Cost to Cover

MIN BET	MAX BET	Cost to Cover	Denomination
40	1600	40	Denomination 1, 2
25	800	25	Denomination 3, 4, 5
10	200	10	Denomination 6
10	100	10	Denomination 7

(Depends on the above Bet Configurations)



FREE GAMES



Any 3 or more trigger the FREE GAMES FEATURE with 9 free games. Different reels are used during the FREE GAMES FEATURE. Reels used during the FREE GAMES contain a greater total number of . FREE GAMES FEATURE can be triggered again during the FREE GAMES FEATURE. FREE GAMES FEATURE starts after the ARROW FEATURE ends if triggered in the same game. If ARROW FEATURE is triggered during the FREE GAMES FEATURE, any remaining free games resume after the ARROW FEATURE ends.

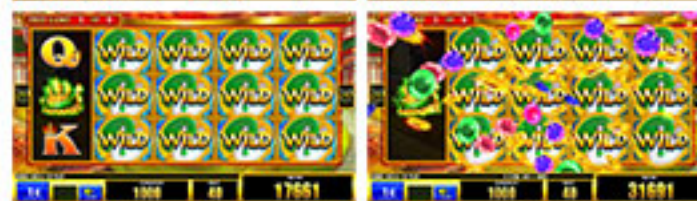

Credits bet and lines played during the FREE GAMES FEATURE are the same as the game that triggered the FREE GAMES FEATURE.

ARROW FEATURE



Any 6 or more in a bought game or during the FREE GAMES FEATURE trigger the ARROW FEATURE and are held for the duration of the ARROW FEATURE. When the ARROW FEATURE is triggered, 3 free spins are awarded.

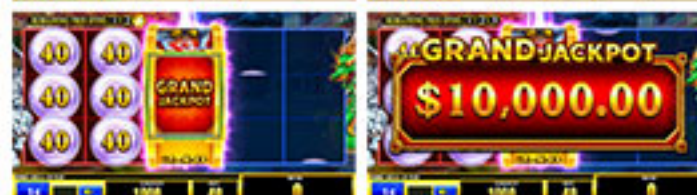

Different reels are used during the ARROW FEATURE. Each symbol position on reels 1, 2, 4 and 5 becomes an individual spinning bonus reel during the ARROW FEATURE.

During the ARROW FEATURE, reel 3 becomes a PRIZE REEL containing the following available prizes on PRIZE SYMBOLS.

- PRIZE AMOUNT:** equal to the total credits bet multiplied by 3, 4, 5, 6, 7, 8, 9, 15 randomly as displayed.
- PRIZE AMOUNT added to :** equal to 24, 36, 40, 48, 56, 60, 80, 84, 112, 120, 160, 180, 200, 240, 300, and 400 credits multiplied by bet multiplier.
- BONUS:** MINI BONUS, MINOR BONUS or MAJOR BONUS
- JACKPOT:** MEGA JACKPOT or GRAND JACKPOT

On the PRIZE REEL on reel 3 in the ARROW FEATURE, only a PRIZE SYMBOL that fully appears within the on reel 3 is awarded.

- If a PRIZE AMOUNT or BONUS PRIZE SYMBOL displaying a is awarded, the value of the prize is added to the value of the prize on each held on reels 1 and 2.
- If a PRIZE AMOUNT or BONUS PRIZE SYMBOL displaying a is awarded, the value of the prize is added to the value of the prize on each held on reels 4 and 5.
- If a PRIZE AMOUNT or BONUS PRIZE SYMBOL displaying both and is awarded, the value of the prize is added to the value of the prize on each held on reels 1, 2, 4 and 5.
- If a PRIZE AMOUNT or BONUS PRIZE SYMBOL without an arrow is awarded, the displayed prize is won and added to the win meter.
- If a JACKPOT PRIZE SYMBOL is awarded, the displayed JACKPOT is won and added to the credit meter.

Any newly appearing in the ARROW FEATURE resets the number of remaining free spins to 3 and is held in position until the ARROW FEATURE ends.

Any PRIZE SYMBOL that fully appears within the on reel 3 resets the number of remaining free spins to 3. Once ceiling is reached contributions are carried over to the next progressive.

ARROW FEATURE ends after all awarded free spins have been played. ARROW FEATURE prizes are added to any line wins occurring in the game that triggers the ARROW FEATURE. Credit Prize values on PRIZE SYMBOLS and on are displayed in currency if their individual value equals 100,000 credits or more. Credits bet during the ARROW FEATURE are the same as the game that triggered the ARROW FEATURE.



Also available in other Cabinet



TYPE OF PRODUCT

LINK / SAP

REEL CONFIGURATION

5-Reel 3-Row Video Slot

PAYLINES

243 Ways

SA DENOMINATIONS

1	2	3	4	5	6	7
R0.01	R0.02	R0.05	R0.10	R0.20	R1	R2
R0.05	R0.10	R0.25	R0.50	R1	R5	R10
R0.10	R0.20	R0.50	R1	R2	R10	R20
R0.50	R1	R2.50	R5	R10	R50	R100
R1	R2	R5	R10	R20	R100	R200

EU DENOMINATIONS

1	2	3	4	5	6	7
€0.01	€0.02	€0.05	€0.10	€0.20	€1	€2
€0.05	€0.10	€0.25	€0.50	€1	€5	€10
€0.10	€0.20	€0.50	€1	€2	€10	€20
€0.50	€1	€2.50	€5	€10	€50	€100
€1	€2	€5	€10	€20	€100	€200

BET CONFIGURATIONS

- 1, 2, 3, 4, 5
- 1, 2, 3, 5, 8
- 1, 2, 3, 5, 10
- 1, 2, 5, 10, 20 (Disabled for Denomination 7)
- 1, 2

MIN/MAX BET & Cost to Cover

MIN BET	MAX BET	Cost to Cover	Denomination
40	1600	40	Denomination 1, 2
25	800	25	Denomination 3, 4, 5
10	200	10	Denomination 6
10	100	10	Denomination 7

(Depends on the above Bet Configurations)



FREE GAMES



Any 3 or more trigger the FREE GAMES FEATURE with 9 free games. Different reels are used during the FREE GAMES FEATURE. Reels used during the FREE GAMES contain a greater total number of . FREE GAMES FEATURE can be triggered again during the FREE GAMES FEATURE. FREE GAMES FEATURE starts after the ARROW FEATURE ends if triggered in the same game. If ARROW FEATURE is triggered during the FREE GAMES FEATURE, any remaining free games resume after the ARROW FEATURE ends.

Credits bet and lines played during the FREE GAMES FEATURE are the same as the game that triggered the FREE GAMES FEATURE.

ARROW FEATURE



Any 6 or more in a bought game or during the FREE GAMES FEATURE trigger the ARROW FEATURE and are held for the duration of the ARROW FEATURE. When the ARROW FEATURE is triggered, 3 free spins are awarded. Different reels are used during the ARROW FEATURE. Each symbol position on reels 1, 2, 4 and 5 becomes an individual spinning bonus reel during the ARROW FEATURE.

During the ARROW FEATURE, reel 3 becomes a PRIZE REEL containing the following available prizes on PRIZE SYMBOLS.

- PRIZE AMOUNT:** equal to the total credits bet multiplied by 3, 4, 5, 6, 7, 8, 9, 15 randomly as displayed.
- PRIZE AMOUNT added to :** equal to 24, 36, 40, 48, 56, 60, 80, 84, 112, 120, 160, 180, 200, 240, 300, and 400 credits multiplied by bet multiplier.
- BONUS:** MINI BONUS, MINOR BONUS or MAJOR BONUS
- JACKPOT:** MEGA JACKPOT or GRAND JACKPOT

On the PRIZE REEL on reel 3 in the ARROW FEATURE, only a PRIZE SYMBOL that fully appears within the on reel 3 is awarded.

- If a PRIZE AMOUNT or BONUS PRIZE SYMBOL displaying a is awarded, the value of the prize is added to the value of the prize on each held on reels 1 and 2.
- If a PRIZE AMOUNT or BONUS PRIZE SYMBOL displaying a is awarded, the value of the prize is added to the value of the prize on each held on reels 4 and 5.
- If a PRIZE AMOUNT or BONUS PRIZE SYMBOL displaying both and is awarded, the value of the prize is added to the value of the prize on each held on reels 1, 2, 4 and 5.
- If a PRIZE AMOUNT or BONUS PRIZE SYMBOL without an arrow is awarded, the displayed prize is won and added to the win meter.
- If a JACKPOT PRIZE SYMBOL is awarded, the displayed JACKPOT is won and added to the credit meter.

Any newly appearing in the ARROW FEATURE resets the number of remaining free spins to 3 and is held in position until the ARROW FEATURE ends.

Any PRIZE SYMBOL that fully appears within the on reel 3 resets the number of remaining free spins to 3. Once ceiling is reached contributions are carried over to the next progressive.

ARROW FEATURE ends after all awarded free spins have been played. ARROW FEATURE prizes are added to any line wins occurring in the game that triggers the ARROW FEATURE. Credit Prize values on PRIZE SYMBOLS and on are displayed in currency if their individual value equals 100,000 credits or more. Credits bet during the ARROW FEATURE are the same as the game that triggered the ARROW FEATURE.

QIAN DUO DUO



Collect the dragon
coins to maximize
your wealth!



Also available in other Cabinet



TYPE OF PRODUCT

[LINK](#) / [SAP](#)

REEL CONFIGURATION

5-Reel 3-Row Video Slot

PAYLINES

243 Ways

SA DENOMINATIONS

1	2	3	4	5	6
R0.01	R0.02	R0.05	R0.10	R1	R2
R0.02	R0.05	R0.10	R0.20	R0.50	R1
R0.05	R0.10	R0.20	R0.50	R1	R2
R0.05	R0.10	R0.20	R0.50	R1	R10
R0.10	R0.20	R0.50	R1	R2	R5
R0.20	R0.50	R1	R2	R5	R10
R0.50	R1	R2	R5	R10	R20
R1	R2	R5	R10	R20	R50
R2	R5	R10	R20	R100	R200
R10	R20	R50	R100	R500	R1,000

EU DENOMINATIONS

1	2	3	4	5	6
€0.01	€0.02	€0.05	€0.10	€1	€2
€0.02	€0.05	€0.10	€0.20	€0.50	€1
€0.05	€0.10	€0.20	€0.50	€1	€2
€0.05	€0.10	€0.20	€0.50	€1	€10
€0.10	€0.20	€0.50	€1	€2	€5
€0.20	€0.50	€1	€2	€5	€10
€0.50	€1	€2	€5	€10	€20
€1	€2	€5	€10	€20	€50
€2	€5	€10	€20	€100	€200
€10	€20	€50	€100	€500	€1,000

BET CONFIGURATIONS

1, 2, 3, 4, 5, 6, 7, 8, 9, 10

MIN/MAX BET & Cost to Cover

MIN BET	MAX BET	Cost to Cover	BET LEVEL
18	180	18	Bet Level 1
28	280	28	Bet Level 2
38	380	38	Bet Level 3
68	680	68	Bet Level 4
88	880	88	Bet Level 5

(Depends on the above Bet Configurations)



COIN SPIN FEATURE



3 scattered appearing on reels 2, 3 and 4 trigger the COIN SPIN FEATURE.

When the COIN SPIN FEATURE is triggered, 3 free spins are awarded.

Each newly appearing displaying "+1 SPIN" in a free spin awards 1 additional free spin.

COIN SPIN FEATURE ends after all awarded free spins have been played.

Credits bet during the COIN SPIN FEATURE are the same as the game that triggered the COIN SPIN FEATURE.

JACKPOT FEATURE



There is a chance that the JACKPOT FEATURE may be triggered when 1 or more appears in bought games only.

In the JACKPOT FEATURE, select from 12 icons until 3 matching symbols corresponding to a JACKPOT level are revealed.

When 3 matching JACKPOT level symbols have been revealed, the corresponding JACKPOT level is won and the JACKPOT FEATURE ends.

SYMBOLS	PRIZE	PRIZE TYPE
	GRAND	JACKPOT
	MAJOR	JACKPOT
	MINOR	BONUS
	MINI	BONUS

The chances of revealing each jackpot symbol are not equal.

BET LEVEL	JACKPOT AND BONUS LEVELS BECOME AVAILABLE
BET 88	GRAND, MAJOR, MINOR, MINI
BET 68	GRAND, MAJOR, MINOR, MINI
BET 38	MAJOR, MINOR, MINI
BET 28	MAJOR, MINOR, MINI
BET 18	MAJOR, MINOR, MINI

A JACKPOT level is reset to its initial value each time that JACKPOT level is won.

JACKPOT FEATURE and COIN SPIN FEATURE cannot be triggered in the same game.



Also available in other Cabinet



TYPE OF PRODUCT

[LINK](#) / [SAP](#)

REEL CONFIGURATION

5-Reel 3-Row Video Slot

PAYLINES

243 Ways

SA DENOMINATIONS

1	2	3	4	5	6
R0.01	R0.02	R0.05	R0.10	R1	R2
R0.02	R0.05	R0.10	R0.20	R0.50	R1
R0.05	R0.10	R0.20	R0.50	R1	R2
R0.05	R0.10	R0.20	R0.50	R1	R10
R0.10	R0.20	R0.50	R1	R2	R5
R0.20	R0.50	R1	R2	R5	R10
R0.50	R1	R2	R5	R10	R20
R1	R2	R5	R10	R20	R50
R2	R5	R10	R20	R100	R200
R10	R20	R50	R100	R500	R1,000

EU DENOMINATIONS

1	2	3	4	5	6
€0.01	€0.02	€0.05	€0.10	€1	€2
€0.02	€0.05	€0.10	€0.20	€0.50	€1
€0.05	€0.10	€0.20	€0.50	€1	€2
€0.05	€0.10	€0.20	€0.50	€1	€10
€0.10	€0.20	€0.50	€1	€2	€5
€0.20	€0.50	€1	€2	€5	€10
€0.50	€1	€2	€5	€10	€20
€1	€2	€5	€10	€20	€50
€2	€5	€10	€20	€100	€200
€10	€20	€50	€100	€500	€1,000

BET CONFIGURATIONS

1, 2, 3, 4, 5, 6, 7, 8, 9, 10

MIN/MAX BET & Cost to Cover

MIN BET	MAX BET	Cost to Cover	BET LEVEL
18	180	18	Bet Level 1
28	280	28	Bet Level 2
38	380	38	Bet Level 3
68	680	68	Bet Level 4
88	880	88	Bet Level 5

(Depends on the above Bet Configurations)



COIN SPIN FEATURE



3 scattered appearing on reels 2, 3 and 4 trigger the COIN SPIN FEATURE.

When the COIN SPIN FEATURE is triggered, 3 free spins are awarded.

Each newly appearing displaying "+1 SPIN" in a free spin awards 1 additional free spin.

COIN SPIN FEATURE ends after all awarded free spins have been played.

Credits bet during the COIN SPIN FEATURE are the same as the game that triggered the COIN SPIN FEATURE.

JACKPOT FEATURE



There is a chance that the JACKPOT FEATURE may be triggered when 1 or more appears in bought games only.

In the JACKPOT FEATURE, select from 12 icons until 3 matching symbols corresponding to a JACKPOT level are revealed.

When 3 matching JACKPOT level symbols have been revealed, the corresponding JACKPOT level is won and the JACKPOT FEATURE ends.

SYMBOLS	PRIZE	PRIZE TYPE
	GRAND	JACKPOT
	MAJOR	JACKPOT
	MINOR	BONUS
	MINI	BONUS

The chances of revealing each jackpot symbol are not equal.

BET LEVEL	JACKPOT AND BONUS LEVELS BECOME AVAILABLE
BET 88	GRAND, MAJOR, MINOR, MINI
BET 68	GRAND, MAJOR, MINOR, MINI
BET 38	MAJOR, MINOR, MINI
BET 28	MAJOR, MINOR, MINI
BET 18	MAJOR, MINOR, MINI

A JACKPOT level is reset to its initial value each time that JACKPOT level is won.

JACKPOT FEATURE and COIN SPIN FEATURE cannot be triggered in the same game.

Fortune Key™



Unlock the
door to many
fortunes!



Also available in other Cabinet



TYPE OF PRODUCT

LINK / SAP

REEL CONFIGURATION

5-Reel 3-Row Video Slot

PAYLINES

50 Lines

SA DENOMINATIONS

1	2	3	4	5
R0.01	R0.02	R0.05	R0.10	R0.20
R0.05	R0.10	R0.25	R0.50	R1
R0.10	R0.20	R0.50	R1	R2
R0.50	R1	R2.50	R5	R10
R1	R2	R5	R10	R20

EU DENOMINATIONS

1	2	3	4	5
€0.01	€0.02	€0.05	€0.10	€0.20
€0.05	€0.10	€0.25	€0.50	€1
€0.10	€0.20	€0.50	€1	€2
€0.50	€1	€2.50	€5	€10
€1	€2	€5	€10	€20

BET CONFIGURATIONS

1, 2, 3, 5, 10

MIN/MAX BET & Cost to Cover

MIN BET	MAX BET	Cost to Cover
75	750	75



FREE GAMES FEATURE



Any 3 or more scattered  in a bought game trigger FREE GAMES FEATURE.

FREE GAMES FEATURE consist of 10 free spin.

FREE GAMES FEATURE can be triggered again during the FREE GAMES FEATURE awarding 10 more free spins.

FREE GAMES FEATURE starts after the FIRST EMPEROR FEATURE ends if triggered in the same game.

If FIRST EMPEROR FEATURE is triggered during the FREE GAMES FEATURE, any remaining free games resume after the FIRST EMPEROR FEATURE ends.

FIRST EMPEROR FEATURE



FIRST EMPEROR FEATURE is triggered when WILD appears in reel 1, reel 2 and at least one  in reel 3, reel 4 and reel 5.

FIRST EMPEROR FEATURE consist of 5 spins.

Any  appears will be held in position on the reels for the duration of FIRST EMPEROR FEATURE.

During the FIRST EMPEROR FEATURE, each symbol position becomes an individual spinning bonus reel.

Before FIRST EMPEROR FEATURE start, reel 1 and reel 2 is locked.

Each new  appearing in the reels during the FIRST EMPEROR FEATURE adds 1 spin and is held in position for the duration of the FIRST EMPEROR FEATURE.

When  appear in all 9 symbol positions, reel 2 will be unlocked.

Reel 2 is spun once for that game only and may award one of the following prizes.

- **PRIZE AMOUNT:** each equal to 1, 2, 3, 4, 5, 6, 7, 8, 10, 12, 15 or 20 credits multiplied by total bet as displayed.
- 

When  is triggered inside reel 2, reel 1 will be unlocked.

After reel 1 unlocked, one of the following prizes will be awarded.

- **MULTIPLIER:** x2, x3 or x5
- **BONUSES:**   
- **JACKPOT:**  or 

Reel 2 prizes will change to greater value and may award one of the following prizes.

- **PRIZE AMOUNT:** each equal to 10, 12, 15 or 20 credits multiplied by total bet as displayed.
- **BONUSES:** 

Reel 1 will spin once for that game only and reel 2 will spin once again.

FIRST EMPEROR FEATURE ends after all awarded free spins have been played.



Also available in other Cabinet



TYPE OF PRODUCT

LINK / SAP

REEL CONFIGURATION

5-Reel 3-Row Video Slot

PAYLINES

50 Lines

SA DENOMINATIONS

1	2	3	4	5
R0.01	R0.02	R0.05	R0.10	R0.20
R0.05	R0.10	R0.25	R0.50	R1
R0.10	R0.20	R0.50	R1	R2
R0.50	R1	R2.50	R5	R10
R1	R2	R5	R10	R20

EU DENOMINATIONS

1	2	3	4	5
€0.01	€0.02	€0.05	€0.10	€0.20
€0.05	€0.10	€0.25	€0.50	€1
€0.10	€0.20	€0.50	€1	€2
€0.50	€1	€2.50	€5	€10
€1	€2	€5	€10	€20

BET CONFIGURATIONS

1, 2, 3, 5, 10

MIN/MAX BET & Cost to Cover

MIN BET	MAX BET	Cost to Cover
75	750	75



FREE GAMES FEATURE



Any 3 or more scattered  in a bought game trigger FREE GAMES FEATURE.

FREE GAMES FEATURE consist of 10 free spin.

Each spin a random Reel from Reels 3, 4, or 5 is selected to have BONUS Symbols only.

FREE GAMES FEATURE can be triggered again during the FREE GAMES FEATURE awarding 10 more free spins.

FREE GAMES FEATURE starts after the JADE EMPRESS FEATURE ends if triggered in the same game.

If JADE EMPRESS FEATURE is triggered during the FREE GAMES FEATURE, any remaining free games resume after the JADE EMPRESS FEATURE ends.

JADE EMPRESS FEATURE

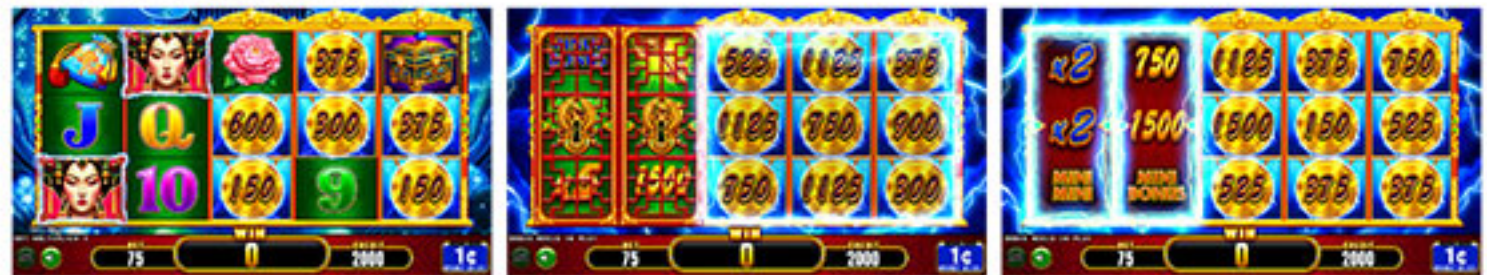

JADE EMPRESS FEATURE is triggered when WILD appears in reel 1, reel 2 and at least one  in reel 3, reel 4 and reel 5.

JADE EMPRESS FEATURE consist of 5 spins.

Any  appears will be held in position on the reels for the duration of JADE EMPRESS FEATURE.

During the JADE EMPRESS FEATURE, each symbol position becomes an individual spinning bonus reel.

Before JADE EMPRESS FEATURE start, reel 1 and reel 2 is locked.

Each new  appearing in the reels during the JADE EMPRESS FEATURE adds 1 spin and is held in position for the duration of the JADE EMPRESS FEATURE.

When  appear in all 9 symbol positions, reel 2 will be unlocked.

Reel 2 is spun once for that game only and may award one of the following prizes.

- PRIZE AMOUNT: each equal to 1, 2, 3, 4, 5, 6, 7, 8, 10, 12, 15 or 20 credits multiplied by total bet as displayed.
- 

When  is triggered inside reel 2, reel 1 will be unlocked.

After reel 1 unlocked, one of the following prizes will be awarded.

- MULTIPLIER: x2, x3 or x5
- BONUSES:  ·  · 
- JACKPOT:  or 

Reel 2 prizes will change to greater value and may award one of the following prizes.

- PRIZE AMOUNT: each equal to 10, 12, 15 or 20 credits multiplied by total bet as displayed.
- BONUSES: 

Reel 1 will spin once for that game only and reel 2 will spin once again.

JADE EMPRESS FEATURE ends after all awarded free spins have been played.

HYPERSPEED

Entertainment has a classy new look.

Players can enjoy an exciting gaming experience.

Optimal service design for accessibility and maintenance.

Stunning HD Graphics

An vertical LCD monitor with 43-inch LCD high definition monitor.

Ergonomic button deck

Premium Speed 11.6-inch LCD Touch Screen panel with Bash Button.

Immersive Audio

Newly designed sound system creates powerful theater-like sound.

USB charging

USB charging port & wireless Charger also provided for player convenience.

DIMENSION

(Without Base Stand)

Upright Height

(Tower Light Included)

2219.9 mm (87.40 in)

Upright Height

(Tower Light Excluded)

2116.9 mm (83.34 in)

Width

680 mm (26.77 in)

Depth

631.1 mm (24.85 in)

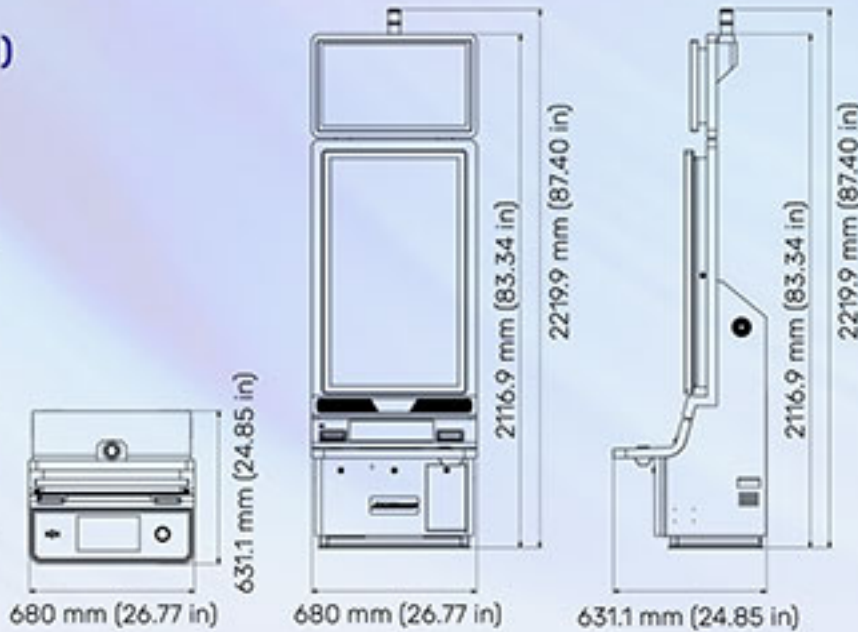

DIMENSION

(With Custom Base Stand)

Upright Height

(Tower Light Included)

2677.1 mm (105.40 in)

Upright Height

(Tower Light Excluded)

2574.1 mm (101.34 in)

Width

680 mm (26.77 in)

Depth

631.1 mm (24.85 in)

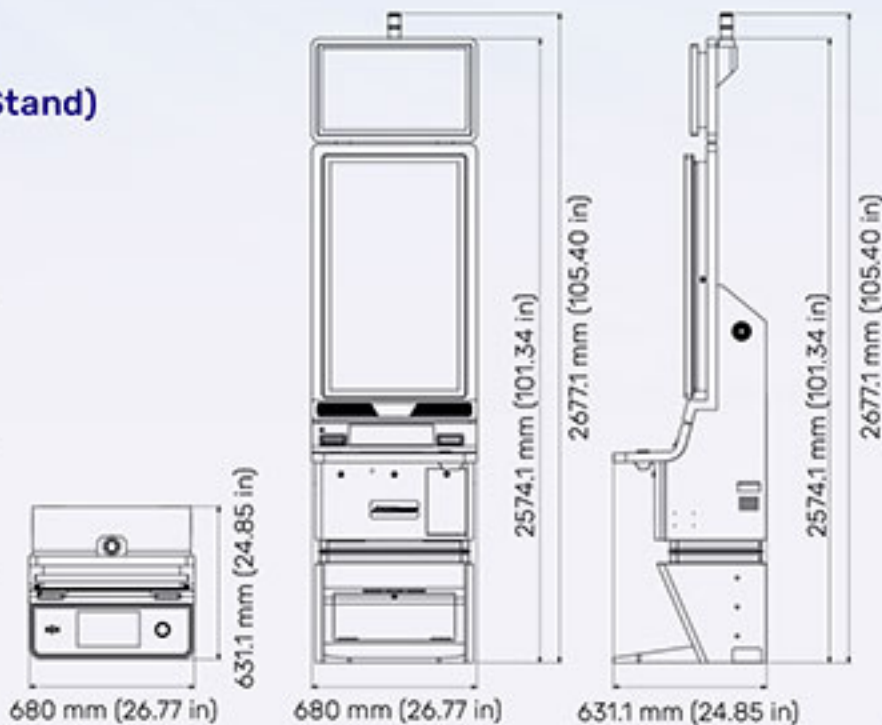

Please contact your Account Executive for more details.

sales@aruzeglobal.com

+1 702-781-8080

www.aruzeglobal.com

Follow us @AruzeGaming



Empire Technological Group Ltd dba
Aruze Gaming Global

GONG CASH™

GRAND
\$2,500.01
MAJOR
\$250.01
MINOR \$20.03 MINI \$10.04

GRAND
\$2,500.01
MAJOR
\$250.01
MINOR \$20.03 MINI \$10.05

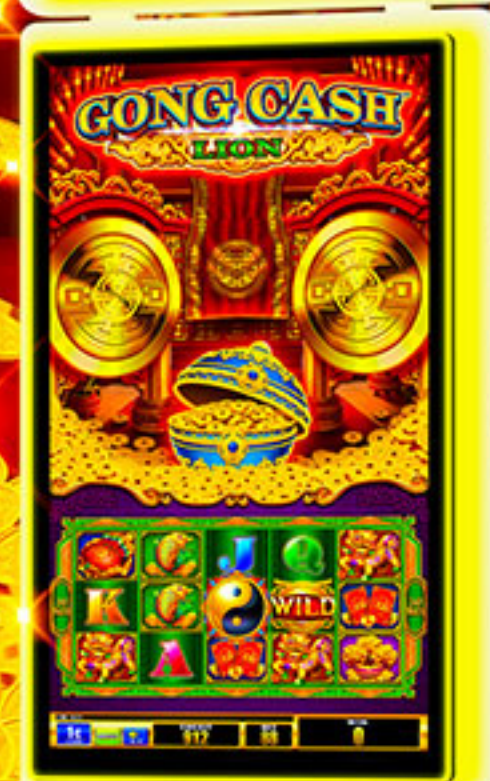
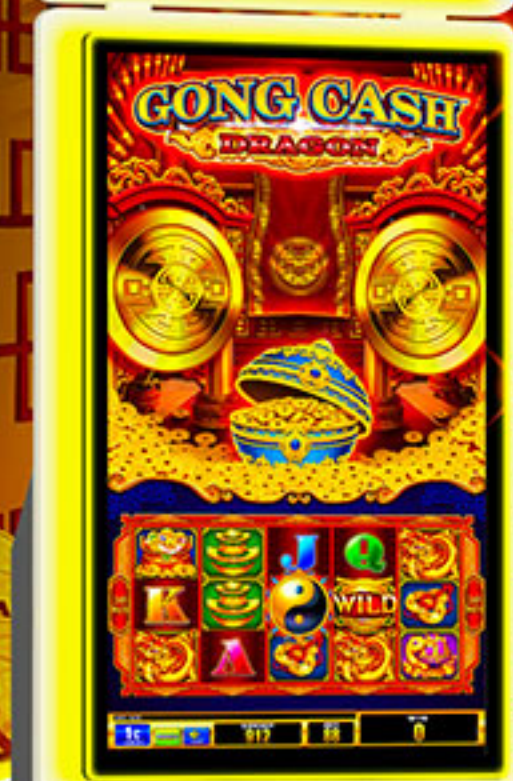

**Fortunes abound
with a cascade of
gold coins in this
thrilling theme!**



Also available in other Cabinet



TYPE OF PRODUCT

[LINK](#) / [SAP](#)

REEL CONFIGURATION

5-Reel 3-Row Video Slot

PAYLINES

243 Ways

DENOMINATIONS

SA R0.10

EU €0.01

BET CONFIGURATIONS

1, 2, 3, 4, 5, 6, 7, 8, 9, 10

MIN/MAX BET & Cost to Cover

MIN BET	MAX BET	Cost to Cover
88	880	88

(Depends on the above Bet Configurations)



GONG SPIN FEATURE

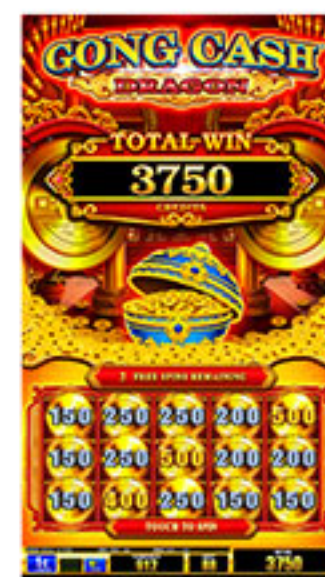
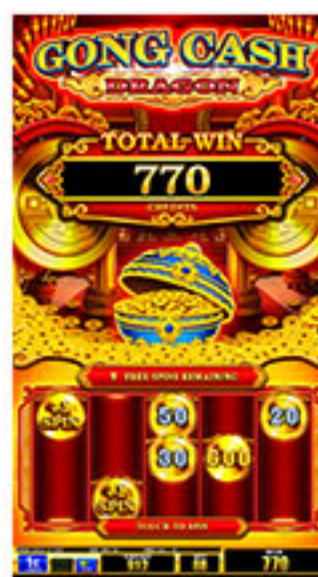
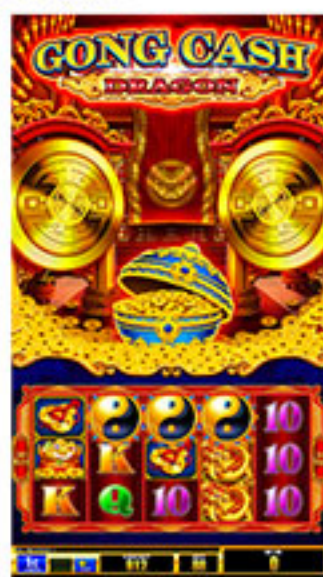

3 scattered appearing on reels 2, 3 and 4 trigger the GONG SPIN FEATURE.

When the GONG SPIN FEATURE is triggered, 3 free spins are awarded.

Each newly appearing displaying "+1 SPIN" in a free spin awards 1 additional free spin.

GONG SPIN FEATURE ends after all awarded free spins have been played.

JACKPOT FEATURE

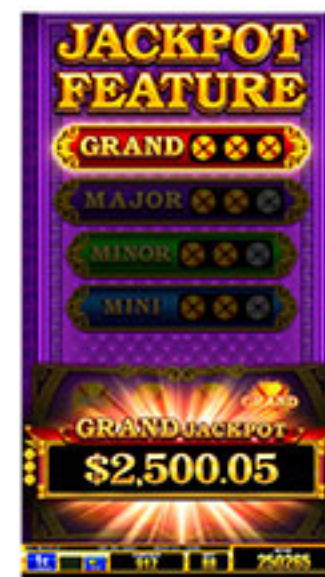
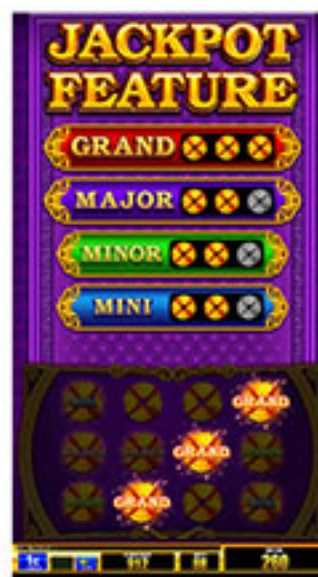
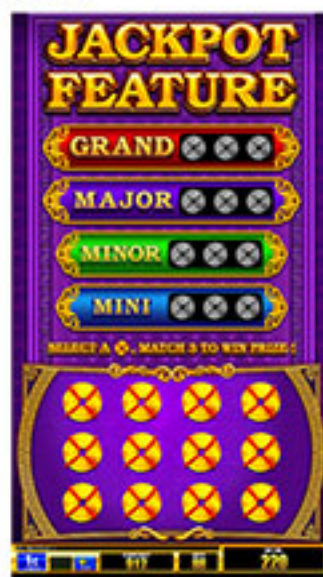

There is a chance that the JACKPOT FEATURE may be triggered when 1 or more appears in bought games only.

In the JACKPOT FEATURE, select from 12 icons until 3 matching symbols corresponding to a JACKPOT level are revealed.

When 3 matching JACKPOT level symbols have been revealed, the corresponding JACKPOT level is won and the JACKPOT FEATURE ends. The chances of revealing each jackpot symbol are not equal.

A JACKPOT level is reset to its initial value each time that JACKPOT level is won.

JACKPOT FEATURE and GONG SPIN FEATURE cannot be triggered in the same game.



Also available in other Cabinet



TYPE OF PRODUCT

[LINK](#) / [SAP](#)

REEL CONFIGURATION

5-Reel 3-Row Video Slot

PAYLINES

243 Ways

DENOMINATIONS

SA R0.10

EU €0.01

BET CONFIGURATIONS

1, 2, 3, 4, 5, 6, 7, 8, 9, 10

MIN/MAX BET & Cost to Cover

MIN BET	MAX BET	Cost to Cover
88	880	88

(Depends on the above Bet Configurations)



GONG SPIN FEATURE

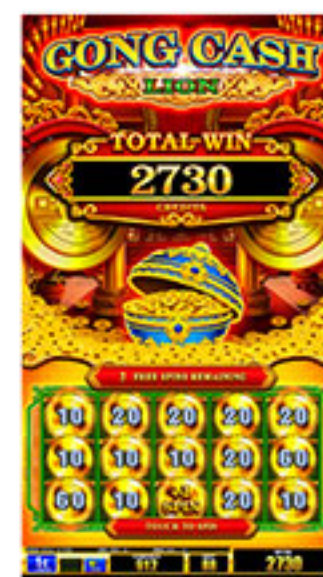
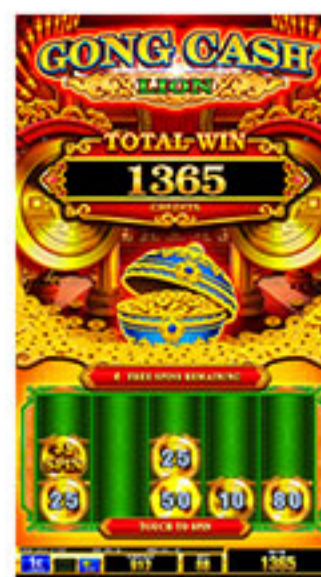

3 scattered appearing on reels 2, 3 and 4 trigger the GONG SPIN FEATURE.

When the GONG SPIN FEATURE is triggered, 3 free spins are awarded.

Each newly appearing displaying "+1 SPIN" in a free spin awards 1 additional free spin.

GONG SPIN FEATURE ends after all awarded free spins have been played.

JACKPOT FEATURE

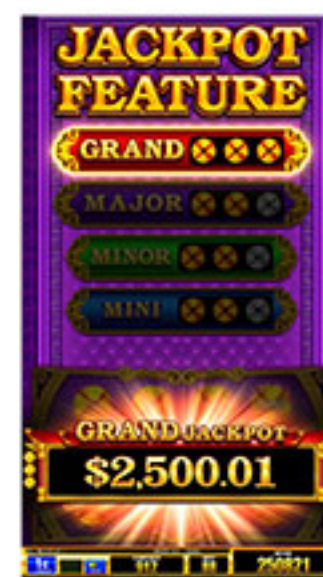
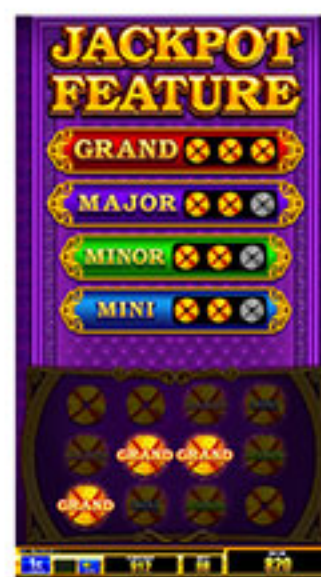
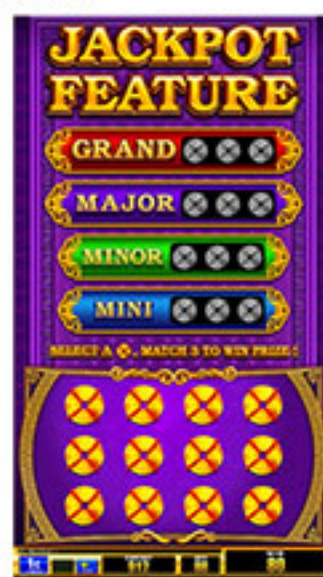

There is a chance that the JACKPOT FEATURE may be triggered when 1 or more appears in bought games only.

In the JACKPOT FEATURE, select from 12 icons until 3 matching symbols corresponding to a JACKPOT level are revealed.

When 3 matching JACKPOT level symbols have been revealed, the corresponding JACKPOT level is won and the JACKPOT FEATURE ends. The chances of revealing each jackpot symbol are not equal.

A JACKPOT level is reset to its initial value each time that JACKPOT level is won.

JACKPOT FEATURE and GONG SPIN FEATURE cannot be triggered in the same game.

FU JIN SHU™

赋金树

GRAND
\$8,800.00
MAJOR
\$800.00
MINOR \$25.01 MINI \$10.03

GRAND
\$8,800.74
MAJOR
\$801.11
MINOR \$26.48 MINI \$12.96

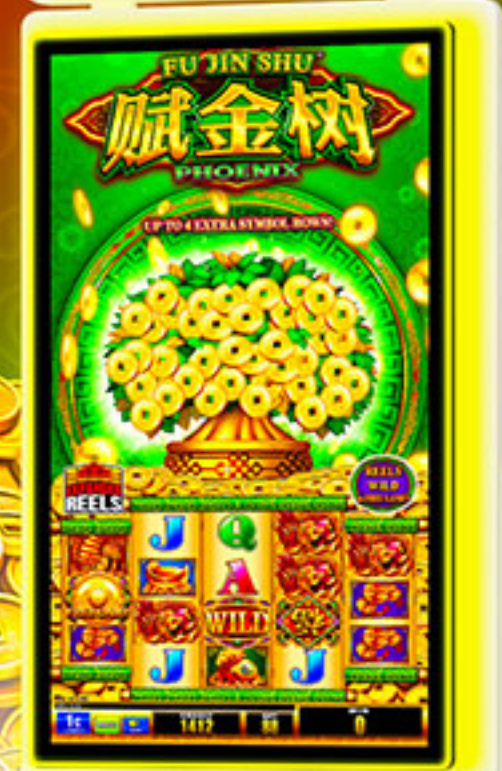
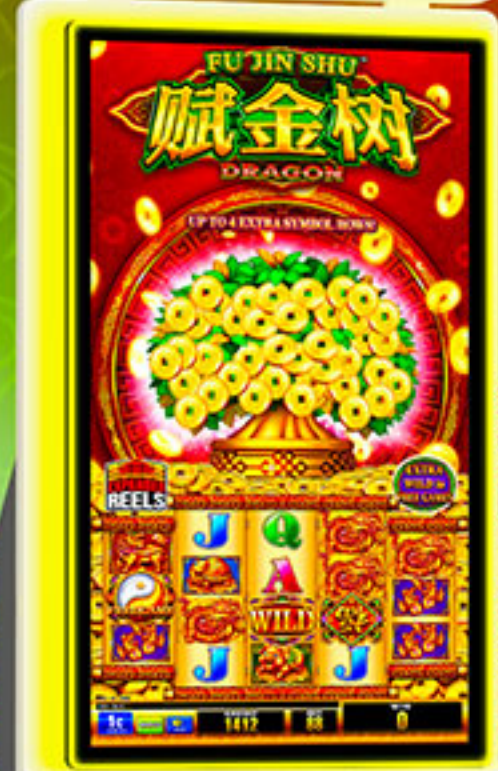

An abundance
of coins on the
great tree results in
blossoming wins!

GRAND	\$8,800.00
MAJOR	\$800.00
MINOR	\$25.01
MINI	\$10.03



TYPE OF PRODUCT

[LINK](#) / [SAP](#)

REEL CONFIGURATION

5-Reel 3-4-4-4-3-Row Video Slot
(EXPANDER REELS: Up to 7-8-8-8-7-Row)

PAYLINES

32 Lines
(EXPANDER REELS: Up to 80 Lines)

DENOMINATIONS

SA R0.10

EU €0.01

BET CONFIGURATIONS

1, 2, 3, 4, 5, 6, 7, 8, 9, 10

MIN/MAX BET & Cost to Cover

MIN BET	MAX BET	Cost to Cover
88	880	88

(Depends on the above Bet Configurations)



EXPANDER REELS

During bought games, 2 scattered appearing on reels 2 and 3 trigger EXPANDER REELS. During free games, EXPANDER REELS are randomly triggered. In the spin that EXPANDER REELS are triggered, all reels are expanded upward 1, 2, 3 or 4 rows of symbols, randomly.

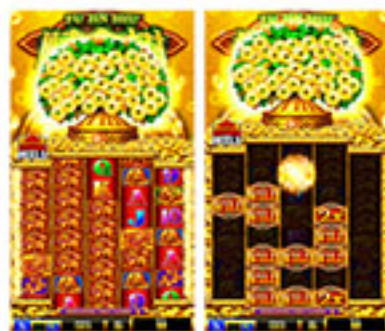

FREE GAMES

3 scattered appearing on reels 1, 3 and 5 trigger 7 free games. Different reels are used during the free games.

EXTRA WILD

If EXPANDER REELS are triggered in a free game, there is a chance that one or more symbol positions randomly become or for that game. All wins determined after the completion of symbol changes has occurred. The sum of multipliers from every / / that substitutes in a win multiplies the pay for that win. Free games start after the JACKPOT FEATURE ends if triggered in the same bought game.

WILD HOLD SPINS

3 scattered appearing on reels 2, 3 and 4 trigger 6 free spins of overlaying reels containing while the reels of the bought game are held. All payable wins for the bought game are determined after the last free spin. When a stops on a symbol position, that symbol position becomes a substitute symbol as described below and is held in position until all wins for the bought game are determined after the last free spin. No wins for any combination during the free spins.

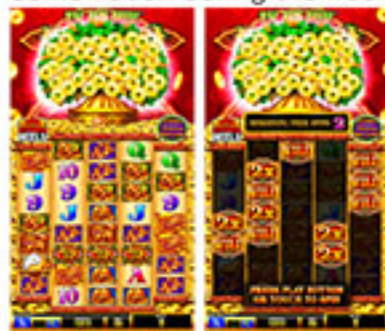

- : If stops on any symbol position.
- : If stops on a symbol position that became .
- : If stops on a symbol position that became .
- : If stops on a symbol position that became .
- : If stops on a symbol position that became .
- : If stops on a symbol position that became .

The sum of multipliers from every / / / / that substitutes in a win multiplies the pay for that win. The row height of the overlay reels used during the free spins are the same as the row height of the reels used in the game that triggered the free spins. WILD HOLD SPINS start after the JACKPOT FEATURE ends if triggered in the same bought game.

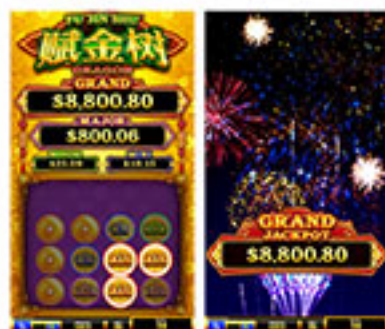

JACKPOT FEATURE

There is a chance that the JACKPOT FEATURE may be triggered when 1 or more appear on reels 2, 3 or 4 in bought games only. on any reel in a bought game that is a result of WILD HOLD SPINS does not offer a chance to trigger the JACKPOT FEATURE. In the JACKPOT FEATURE, there are 4 types of jackpot symbols hidden behind 12 icons. Select an icon until 3 matching jackpot symbols corresponding to a JACKPOT are revealed. When 3 matching jackpot symbols have been revealed, the corresponding JACKPOT is won and the JACKPOT FEATURE ends. JACKPOT FEATURE and BONUS SURPRISE cannot be triggered in the same game.



BONUS SURPRISE

There is a chance that the BONUS SURPRISE may be triggered when 1 or more appear on reels 2, 3 or 4 in bought games only. on any reel in a bought game that is a result of WILD HOLD SPINS does not offer a chance to trigger the BONUS SURPRISE. When the BONUS SURPRISE occurs, 10000 credits multiplied by bet multiplier as displayed are awarded. BONUS SURPRISE and JACKPOT FEATURE cannot be triggered in the same game. Any BONUS SURPRISE win is added to line wins.



EXPANDER REELS

During bought games, 2 scattered appearing on reels 2 and 3 trigger EXPANDER REELS. During free games, EXPANDER REELS are randomly triggered. In the spin that EXPANDER REELS are triggered, all reels are expanded upward 1, 2, 3 or 4 rows of symbols, randomly.

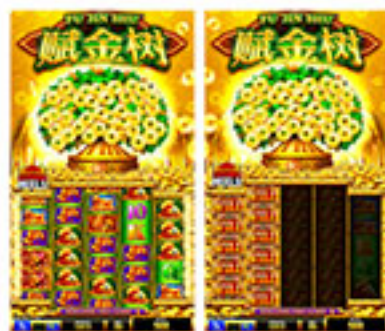

FREE GAMES

3 scattered appearing on reels 1, 3 and 5 trigger 7 free games. Different reels are used during the free games.

REELS WILD

If EXPANDER REELS are triggered in a free game, there is a chance that all symbol positions on 2 or 3 reels become either or in that game. All wins determined after the completion of symbol changes has occurred. The sum of multipliers from every that substitutes in a win multiplies the pay for that win. Free games start after the JACKPOT FEATURE ends if triggered in the same bought game.

WILD HOLD SPINS

3 scattered appearing on reels 2, 3 and 4 trigger 6 free spins of overlaying reels containing while the reels of the bought game are held. All payable wins for the bought game are determined after the last free spin. When a stops on a symbol position, that symbol position becomes a substitute symbol as described below and is held in position until all wins for the bought game are determined after the last free spin. No wins for any combination during the free spins.

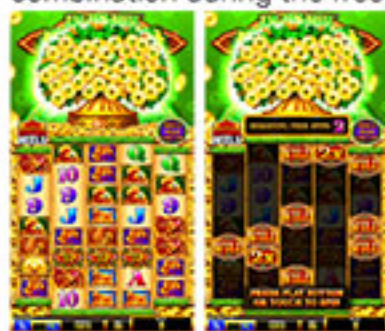

- : If stops on any symbol position.
- : If stops on a symbol position that became .
- : If stops on a symbol position that became .
- : If stops on a symbol position that became .
- : If stops on a symbol position that became .
- : If stops on a symbol position that became .

The sum of multipliers from every / / / / that substitutes in a win multiplies the pay for that win. The row height of the overlay reels used during the free spins are the same as the row height of the reels used in the game that triggered the free spins. WILD HOLD SPINS start after the JACKPOT FEATURE ends if triggered in the same bought game.

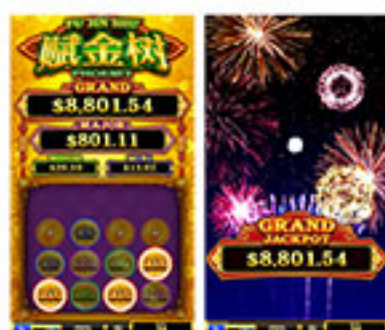

JACKPOT FEATURE

There is a chance that the JACKPOT FEATURE may be triggered when 1 or more appear on reels 2, 3 or 4 in bought games only. on any reel in a bought game that is a result of WILD HOLD SPINS does not offer a chance to trigger the JACKPOT FEATURE. In the JACKPOT FEATURE, there are 4 types of jackpot symbols hidden behind 12 icons. Select an icon until 3 matching jackpot symbols corresponding to a JACKPOT are revealed. When 3 matching jackpot symbols have been revealed, the corresponding JACKPOT is won and the JACKPOT FEATURE ends. JACKPOT FEATURE and BONUS SURPRISE cannot be triggered in the same game.

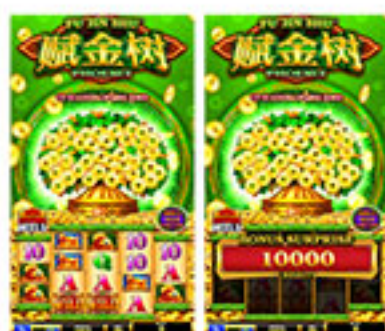

BONUS SURPRISE

There is a chance that the BONUS SURPRISE may be triggered when 1 or more appear on reels 2, 3 or 4 in bought games only. on any reel in a bought game that is a result of WILD HOLD SPINS does not offer a chance to trigger the BONUS SURPRISE. When the BONUS SURPRISE occurs, 10000 credits multiplied by bet multiplier as displayed are awarded. BONUS SURPRISE and JACKPOT FEATURE cannot be triggered in the same game. Any BONUS SURPRISE win is added to line wins.

TYPE OF PRODUCT

[LINK](#) / [SAP](#)

REEL CONFIGURATION

5-Reel 3-4-4-4-3-Row Video Slot
(EXPANDER REELS: Up to 7-8-8-8-7-Row)

PAYLINES

32 Lines
(EXPANDER REELS: Up to 80 Lines)

DENOMINATIONS

SA R0.10

EU €0.01

BET CONFIGURATIONS

1, 2, 3, 4, 5, 6, 7, 8, 9, 10

MIN/MAX BET & Cost to Cover

MIN BET	MAX BET	Cost to Cover
88	880	88

(Depends on the above Bet Configurations)

CAI YUN LAI™

财运来



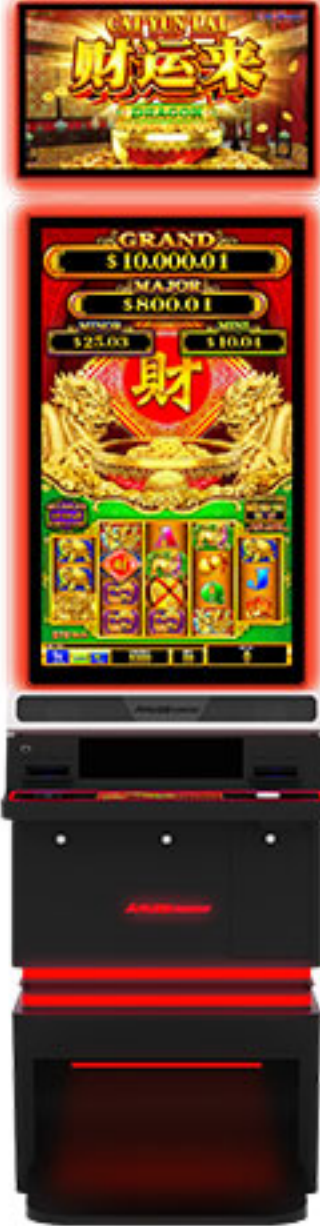

FREE GAMES



 appearing on 3 or more consecutive reels beginning with the leftmost reel trigger the free games. Different reels are used during the free games. Before free games start, select 1 of 3 free game options to play.



Every multiplier on  substituting in a win multiplies the pay for that win.

During the free games,  appearing on 2 or more consecutive reels beginning with the leftmost reel award 3 additional free games.

Free games start after the JACKPOT FEATURE ends if triggered in the same game.

If JACKPOT FEATURE is triggered during free games, any remaining free games resume after JACKPOT FEATURE ends.

JACKPOT FEATURE

There is a chance that the JACKPOT FEATURE may be triggered when 1 or more  appears.



In the JACKPOT FEATURE, select from 12 icons until 3 matching symbols corresponding to a JACKPOT level are revealed.

When 3 matching JACKPOT level symbols have been revealed, the corresponding JACKPOT level is won and the JACKPOT FEATURE ends.

JACKPOT levels available according to GOLD PAYS played. The chances of revealing each jackpot symbol are not equal.

JACKPOT FEATURE and BONUS SURPRISE cannot be triggered in the same game.

BONUS SURPRISE



There is a chance that the BONUS SURPRISE may be triggered when 1 or more  appears.

When the BONUS SURPRISE occurs, 250000 credits are awarded.

BONUS SURPRISE and JACKPOT FEATURE cannot be triggered in the same game.

Any BONUS SURPRISE win is added to line wins.

TYPE OF PRODUCT

[LINK](#) / [SAP](#)

REEL CONFIGURATION

5-Reel 3-4-4-4-3-Row Video Slot

PAYLINES

576 Ways

DENOMINATIONS

SA R0.10

EU €0.01

BET CONFIGURATIONS

1, 2, 3, 4, 5, 6, 7, 8, 9, 10

MIN/MAX BET & Cost to Cover

MIN BET	MAX BET	Cost to Cover
88	880	88

(Depends on the above Bet Configurations)



FREE GAMES



appearing on 3 or more consecutive reels beginning with the leftmost reel trigger the free games. Different reels are used during the free games. Before free games start, select 1 of 4 free game options to play.



During the free games, appearing on 2 or more consecutive reels beginning with the leftmost reel award 3 additional free games within the free game option being played.

Free games start after the JACKPOT FEATURE ends if triggered in the same game.

If JACKPOT FEATURE is triggered during free games, any remaining free games resume after JACKPOT FEATURE ends.

TYPE OF PRODUCT

[LINK](#) / [SAP](#)

REEL CONFIGURATION

5-Reel 3-4-4-4-3-Row Video Slot

PAYLINES

576 Ways

DENOMINATIONS

SA R0.10

EU €0.01

BET CONFIGURATIONS

1, 2, 3, 4, 5, 6, 7, 8, 9, 10

MIN/MAX BET & Cost to Cover

MIN BET	MAX BET	Cost to Cover
88	880	88

(Depends on the above Bet Configurations)

JACKPOT FEATURE

There is a chance that the JACKPOT FEATURE may be triggered when 1 or more appears.



In the JACKPOT FEATURE, select from 12 icons until 3 matching symbols corresponding to a JACKPOT level are revealed.

When 3 matching JACKPOT level symbols have been revealed, the corresponding JACKPOT level is won and the JACKPOT FEATURE ends.

JACKPOT levels available according to GOLD PAYS played. The chances of revealing each jackpot symbol are not equal.

JACKPOT FEATURE and BONUS SURPRISE cannot be triggered in the same game.

BONUS SURPRISE



There is a chance that the BONUS SURPRISE may be triggered when 1 or more appears.

When the BONUS SURPRISE occurs, 250000 credits are awarded.

BONUS SURPRISE and JACKPOT FEATURE cannot be triggered in the same game.

Any BONUS SURPRISE win is added to line wins.

HYPER Speed



FREE GAMES



appearing on 3 or more consecutive reels beginning with the leftmost reel trigger 6 free games. Different reels are used during the free games.

At the start of each free game, randomly determined symbol positions on 2 to 4 reels become for that free game only.

The number of positions that can randomly become corresponds to the GOLD PAYS played, the number of reels that random appears on and the reel number as described below.

GOLD PAYS	RANDOM APPEARING ON TWO REELS					RANDOM APPEARING ON THREE REELS					RANDOM APPEARING ON FOUR REELS				
	1	2	3	4	5	1	2	3	4	5	1	2	3	4	5
MAX GOLD PAYS	3	4	4	4	3	2	3	3	3	3	2	3	3	3	3
GOLD PAYS 4	3	4	4	4	3	2	3	3	3	3	2	3	3	3	3
GOLD PAYS 3	2	2	2	2	3	2	3	3	3	2	2	3	3	3	3
GOLD PAYS 2	2	2	2	2	3	2	3	3	3	2	2	3	3	3	3

All wins determined on stopped reels after the completion of all symbol changes.

Free games cannot be triggered again during the free games.

Free games start after the JACKPOT FEATURE ends if triggered in the same bought game.

If JACKPOT FEATURE is triggered during free games, any remaining free games resume after JACKPOT FEATURE ends.

JACKPOT FEATURE

There is a chance that the JACKPOT FEATURE may be triggered when 1 or more appears.



In the JACKPOT FEATURE, select from 12 icons until 3 matching symbols corresponding to a JACKPOT level are revealed.

When 3 matching JACKPOT level symbols have been revealed, the corresponding JACKPOT level is won and the JACKPOT FEATURE ends.

JACKPOT levels available according to GOLD PAYS played. The chances of revealing each jackpot symbol are not equal.

JACKPOT FEATURE and BONUS SURPRISE cannot be triggered in the same game.

BONUS SURPRISE



There is a chance that the BONUS SURPRISE may be triggered when 1 or more appears.

When the BONUS SURPRISE occurs, 250000 credits are awarded.

BONUS SURPRISE and JACKPOT FEATURE cannot be triggered in the same game.

Any BONUS SURPRISE win is added to line wins.

TYPE OF PRODUCT

[LINK](#) / [SAP](#)

REEL CONFIGURATION

5-Reel 3-4-4-4-3-Row Video Slot

PAYLINES

576 Ways

DENOMINATIONS

SA R0.10

EU €0.01

BET CONFIGURATIONS

1, 2, 3, 4, 5, 6, 7, 8, 9, 10

MIN/MAX BET & Cost to Cover

MIN BET	MAX BET	Cost to Cover
88	880	88

(Depends on the above Bet Configurations)

FU RU YI 福如意

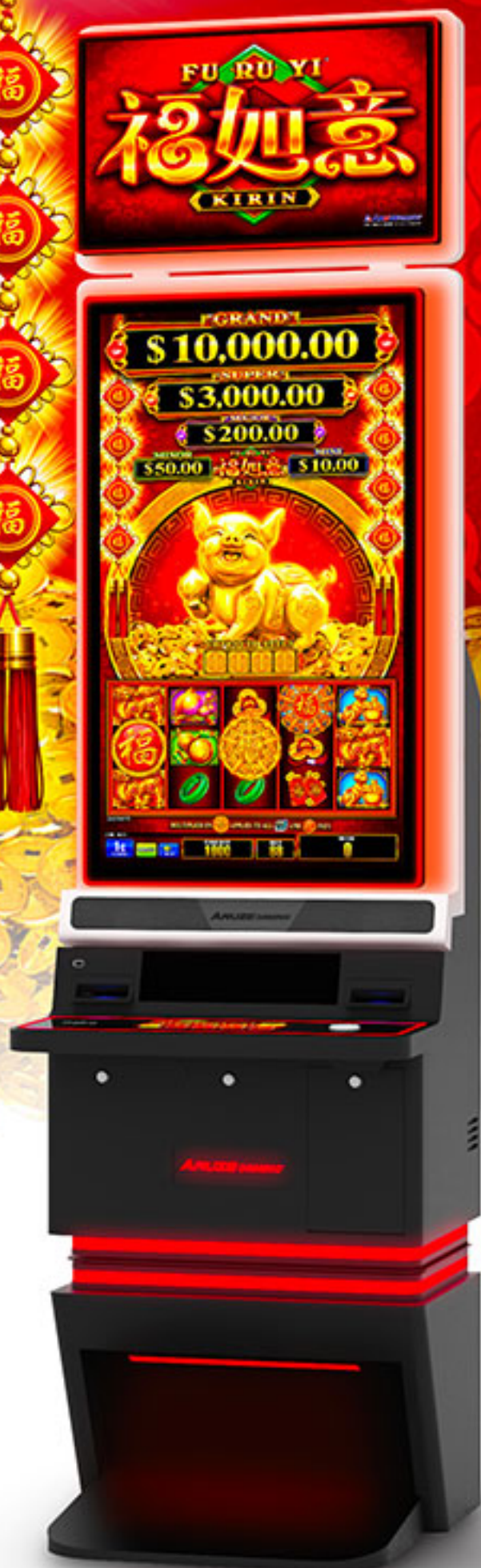

**Customize your
game play for
greater fortunes!**

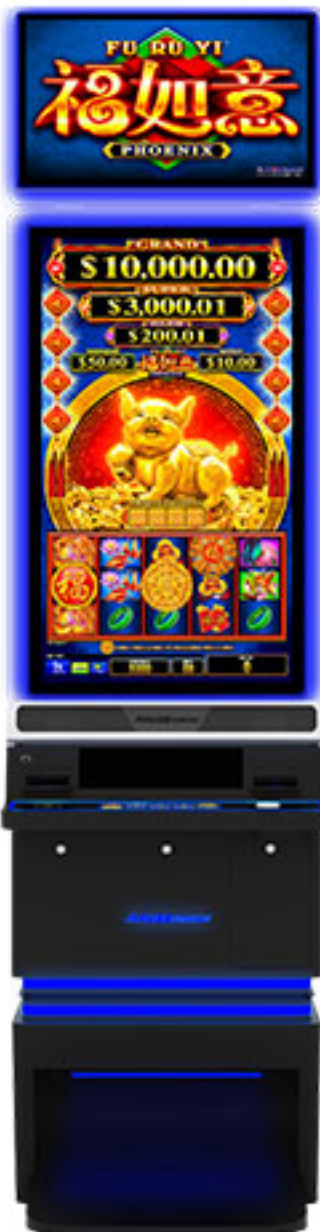

TYPE OF PRODUCT

[LINK](#) / [SAP](#)

REEL CONFIGURATION

5-Reel 3-Row Video Slot

PAYLINES

243 Ways
(FREE GAMES: 1024 or 3125 or 7776 WAYS)

DENOMINATIONS

SA R0.10
EU €0.01

BET CONFIGURATIONS

1, 2, 3, 6, 10

MIN/MAX BET & Cost to Cover

MIN BET	MAX BET	Cost to Cover	BET LEVEL
18	180	18	Bet Level 1
38	380	38	Bet Level 2
58	580	58	Bet Level 3
78	780	78	Bet Level 4
88	880	88	Bet Level 5

(Depends on the above Bet Configurations)



IMPROVED REELS

PLAY OPTIONS	
PLAY 88 REELS	Reels do not contain A, K, Q and J.
PLAY 78 REELS	Reels do not contain K, Q and J.
PLAY 58 REELS	Reels do not contain Q and J.
PLAY 38 REELS	Reels do not contain J.
PLAY 18 REELS	Reels contain all symbols.

Reels contains fewer lower-paying symbols



FORTUNE BONUS

FORTUNE BONUS randomly occurs in bought games and free games.



FREE GAMES FEATURE

appearing on 3 or more consecutive reels beginning with the leftmost reel trigger the free games.

Select reel format and then reel type from the available free game options.

If appears in the game that triggers the free games, the number of free games is increased for the free game options.

The number of free games awarded depends on the selection of reel format and the inclusion of , and on the reels.

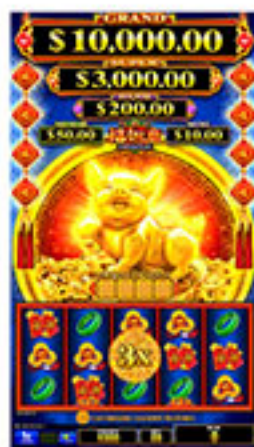

JACKPOT FEATURE

There is a chance the JACKPOT FEATURE may be triggered when 1 or more / appear.

If appears in the game that triggered the JACKPOT FEATURE, a total of 3 JACKPOT FEATURES are awarded and played one after the other.

Select an icon by touching it on the screen, or randomly select an icon by pressing the PLAY button.

When 3 matching symbols have been revealed, the corresponding PRIZE is won and the JACKPOT FEATURE ends.

The JACKPOT FEATURE awards the following:

- 3 JACKPOT LEVELS: GRAND, SUPER, MAJOR
- 2 BONUS PRIZES: MINOR and MINI

BONUS PRIZES INCREASED IN EXCESS OF BET MULTIPLIER

BET MULTIPLIER	BONUS PRIZES	
	MINOR	MINI
x10	\$1,000.00	\$200.00
x6	\$500.00	\$100.00
x3	\$200.00	\$40.00
x2	\$125.00	\$25.00
x1	\$50.00	\$10.00



TYPE OF PRODUCT

[LINK](#) / [SAP](#)

REEL CONFIGURATION

5-Reel 3-Row Video Slot

PAYLINES

243 Ways
(FREE GAMES: 1024 or 3125 or 7776 WAYS)

DENOMINATIONS

SA R0.10
EU €0.01

BET CONFIGURATIONS

1, 2, 3, 6, 10

MIN/MAX BET & Cost to Cover

MIN BET	MAX BET	Cost to Cover	BET LEVEL
18	180	18	Bet Level 1
38	380	38	Bet Level 2
58	580	58	Bet Level 3
78	780	78	Bet Level 4
88	880	88	Bet Level 5

(Depends on the above Bet Configurations)

IMPROVED REELS



PLAY OPTIONS	
PLAY 88 REELS	Reels do not contain A, K, Q and J.
PLAY 78 REELS	Reels do not contain K, Q and J.
PLAY 58 REELS	Reels do not contain Q and J.
PLAY 38 REELS	Reels do not contain J.
PLAY 18 REELS	Reels contain all symbols.

Reels contains fewer lower-paying symbols

FORTUNE BONUS



FORTUNE BONUS randomly occurs in bought games and free games.

FREE GAMES FEATURE

appearing on 3 or more consecutive reels beginning with the leftmost reel trigger the free games.

Select reel format and then max multiplier from the available free game options.

If appears in the game that triggers the free games, the number of free games is increased for the free game options.

If appears in a free game, all pays in that spin are multiplied by the multiplier displayed on .

JACKPOT FEATURE

There is a chance the JACKPOT FEATURE may be triggered when 1 or more / appear.

If appears in the game that triggered the JACKPOT FEATURE, a total of 3 JACKPOT FEATURES are awarded and played one after the other.

Select an icon by touching it on the screen, or randomly select an icon by pressing the PLAY button.

When 3 matching symbols have been revealed, the corresponding PRIZE is won and the JACKPOT FEATURE ends.

The JACKPOT FEATURE awards the following:

- 3 JACKPOT LEVELS: GRAND, SUPER, MAJOR
- 2 BONUS PRIZES: MINOR and MINI

BONUS PRIZES INCREASED IN EXCESS OF BET MULTIPLIER

BET MULTIPLIER	BONUS PRIZES	
	MINOR	MINI
x10	\$1,000.00	\$200.00
x6	\$500.00	\$100.00
x3	\$200.00	\$40.00
x2	\$125.00	\$25.00
x1	\$50.00	\$10.00

FIRESTORM™



**Special fireball
symbols unlocking
rows and awarding
blazing prizes!**

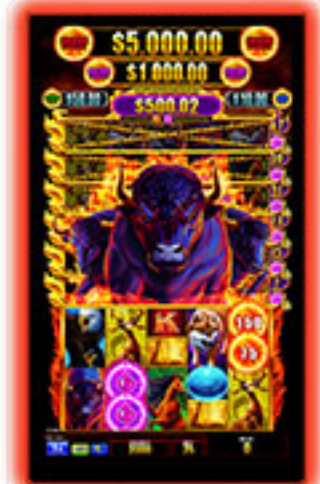

Also available in other Cabinet



TYPE OF PRODUCT

LINK / SAP

REEL CONFIGURATION

5-Reel 4-Row Video Slot
(Up to 10 rows during RISING FIRE)

PAYLINES

50 Lines

SA DENOMINATIONS

1	2	3	4	5
R0.01	R0.02	R0.05	R0.10	R0.20
R0.05	R0.10	R0.25	R0.50	R1
R0.10	R0.20	R0.50	R1	R2
R0.50	R1	R2.50	R5	R10
R1	R2	R5	R10	R20

EU DENOMINATIONS

1	2	3	4	5
€0.01	€0.02	€0.05	€0.10	€0.20
€0.05	€0.10	€0.25	€0.50	€1
€0.10	€0.20	€0.50	€1	€2
€0.50	€1	€2.50	€5	€10
€1	€2	€5	€10	€20

BET CONFIGURATIONS

1, 2, 3, 4, 5, 8, 10

MIN/MAX BET & Cost to Cover

MIN BET	MAX BET	Cost to Cover
75	975	75

(Depends on the above Bet Configurations)



FREE GAMES FEATURE

appearing on 3 or more consecutive reels beginning with the leftmost reel trigger the FREE GAMES FEATURE.

The sum of the numbers that appeared is awarded as FREE GAMES in the FREE GAMES FEATURE. When the FREE GAMES FEATURE is triggered, a number appears on each that was involved in triggering the feature. 1, 2, 3, 5, 7 or 10 free games are awarded for each .

If RISING FIRE is triggered during the FREE GAMES FEATURE, any remaining free games resume after RISING FIRE ends.

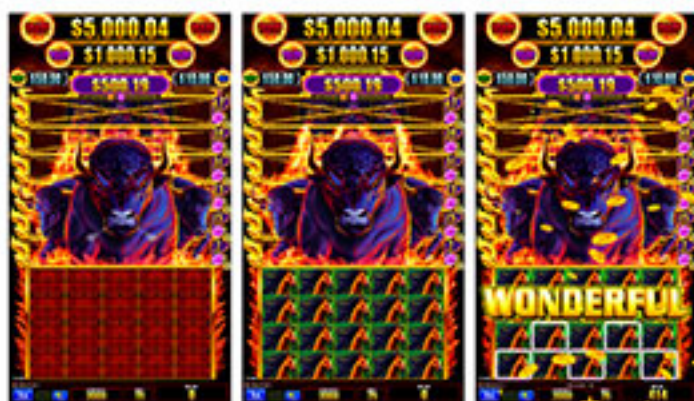

MYSTERY SYMBOL

During bought games, appearing on the reels changes to after all reels finish spinning. A, K, Q, J, 10 or 9

During FREE GAMES FEATURE, appearing on the reels changes to or after all reels finish spinning.

All appearing in the same game randomly change to the same symbol. If appears, wins are determined after finishes changing.



RISING FIRE

Any 6 or more / in a bought game or free game trigger RISING FIRE.

During RISING FIRE, all symbol positions become individual spinning bonus reels. Any that trigger RISING FIRE or appear during RISING FIRE are held for the duration of RISING FIRE.

Any that trigger RISING FIRE or appear during RISING FIRE decrease the remaining number of needed to unlock bonus symbol rows and decrease the number of remaining needed to win the UP UP JACKPOT. When RISING FIRE is triggered, 3 free spins are awarded.

Each newly appearing / in a free spin resets the number of remaining free spins to 3.

RISING FIRE ends after all awarded free spins have been played or if fills every symbol position.

Any unlocked bonus symbol row is locked again after RISING FIRE ends.

The number of remaining required to unlock any bonus symbol row is reset after RISING FIRE ends.

The number of remaining required to win the UP UP JACKPOT is reset after RISING FIRE ends.

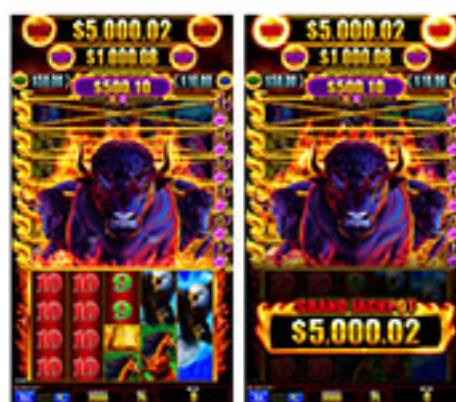

JACKPOT SURPRISE RISING FIRE

There is a chance that 1 JACKPOT is randomly won in bought games except when FREE GAMES FEATURE or RISING FIRE is triggered.

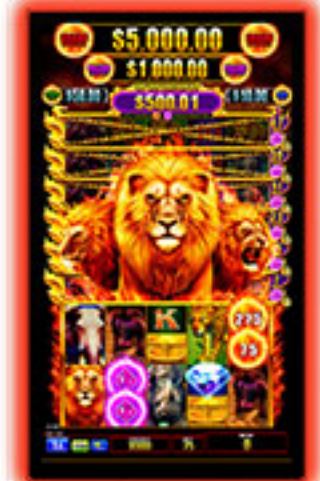

Also available in other Cabinet



TYPE OF PRODUCT

[LINK](#) / [SAP](#)

REEL CONFIGURATION

5-Reel 4-Row Video Slot
(Up to 10 rows during RISING FIRE)

PAYLINES

50 Lines

SA DENOMINATIONS

1	2	3	4	5
R0.01	R0.02	R0.05	R0.10	R0.20
R0.05	R0.10	R0.25	R0.50	R1
R0.10	R0.20	R0.50	R1	R2
R0.50	R1	R2.50	R5	R10
R1	R2	R5	R10	R20

EU DENOMINATIONS

1	2	3	4	5
€0.01	€0.02	€0.05	€0.10	€0.20
€0.05	€0.10	€0.25	€0.50	€1
€0.10	€0.20	€0.50	€1	€2
€0.50	€1	€2.50	€5	€10
€1	€2	€5	€10	€20

BET CONFIGURATIONS

1, 2, 3, 4, 5, 8, 10

MIN/MAX BET & Cost to Cover

MIN BET	MAX BET	Cost to Cover
75	975	75

(Depends on the above Bet Configurations)



FREE GAMES FEATURE

appearing on 3 or more consecutive reels beginning with the leftmost reel trigger the FREE GAMES FEATURE. When the FREE GAMES FEATURE is triggered, a number appears on each that was involved in triggering the feature. 1, 2, 3, 5, 7 or 10 free games are awarded for each . The sum of the numbers that appeared is awarded as FREE GAMES in the FREE GAMES FEATURE. FREE GAMES FEATURE can be triggered again during the FREE GAMES FEATURE. FREE GAMES FEATURE starts after RISING FIRE ends if triggered in the same game. If RISING FIRE is triggered during the FREE GAMES FEATURE, any remaining free games resume after RISING FIRE ends.

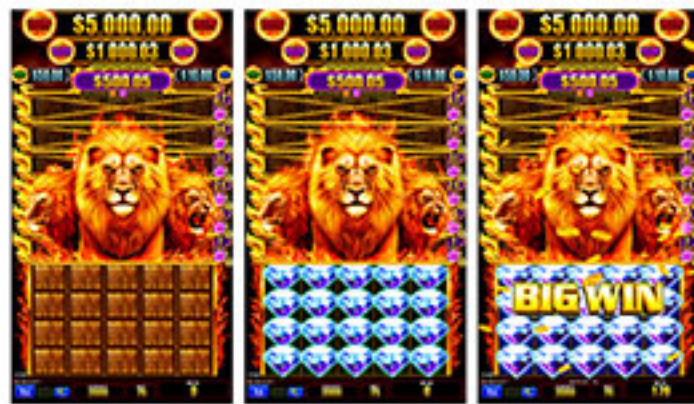

MYSTERY SYMBOL

appearing on the reels changes to after all reels finish spinning. All appearing in the same game randomly change to the same symbol. If appears, wins are determined after finishes changing. Does not appear during RISING FIRE.

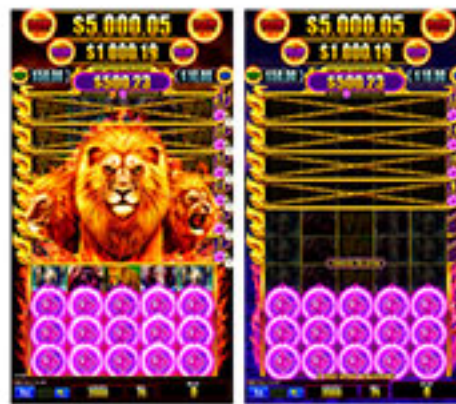

RISING FIRE

Any 6 or more in a bought game or free game trigger RISING FIRE. During RISING FIRE, all symbol positions become individual spinning bonus reels. Any that trigger RISING FIRE or appear during RISING FIRE are held for the duration of RISING FIRE. Any that trigger RISING FIRE or appear during RISING FIRE decrease the remaining number of needed to unlock bonus symbol rows and decrease the number of remaining needed to win the UP UP JACKPOT. When RISING FIRE is triggered, 3 free spins are awarded.

Each newly appearing in a free spin resets the number of remaining free spins to 3.

RISING FIRE ends after all awarded free spins have been played or if fills every symbol position.

Any unlocked bonus symbol row is locked again after RISING FIRE ends.

The number of remaining required to unlock any bonus symbol row is reset after RISING FIRE ends.

The number of remaining required to win the UP UP JACKPOT is reset after RISING FIRE ends.

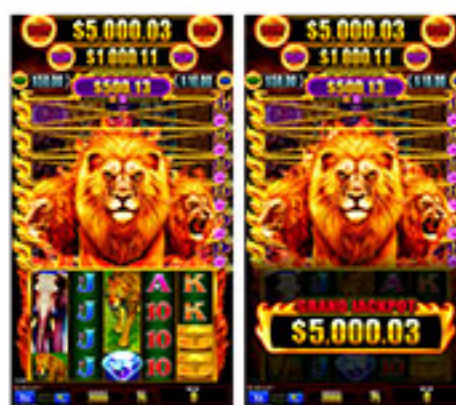

JACKPOT SURPRISE RISING FIRE

There is a chance that 1 JACKPOT is randomly won in bought games except when FREE GAMES FEATURE or RISING FIRE is triggered.

GONGGONG LAIFU™



**The sound
of the Gong brings
good fortune!**



Also available in other Cabinet



TYPE OF PRODUCT

[LINK](#) / [SAP](#)

REEL CONFIGURATION

5-Reel 3-Row Video Slot

PAYLINES

10, 25, 50 Lines (Denomination 1, 2)
5, 10, 25 Lines (Denomination 3, 4, 5)
5 Lines (Denomination 6, 7, 8)

SA DENOMINATIONS

1	2	3	4	5	6	7	8
R0.01	R0.02	R0.05	R0.10	R0.20	R1	R2	R5
R0.05	R0.10	R0.25	R0.50	R1	R5	R10	R25
R0.10	R0.20	R0.50	R1	R2	R10	R20	R50
R0.50	R1	R2.50	R5	R10	R50	R100	R250
R1	R2	R5	R10	R20	R100	R200	R500

EU DENOMINATIONS

1	2	3	4	5	6	7	8
€0.01	€0.02	€0.05	€0.10	€0.20	€1	€2	€5
€0.05	€0.10	€0.25	€0.50	€1	€5	€10	€25
€0.10	€0.20	€0.50	€1	€2	€10	€20	€50
€0.50	€1	€2.50	€5	€10	€50	€100	€250
€1	€2	€5	€10	€20	€100	€200	€500

BET CONFIGURATIONS

1, 2, 3, 4, 5
1, 2, 3, 5, 8
1, 2, 3, 5, 10
1, 2, 5, 10, 20

MIN/MAX BET & Cost to Cover

MIN BET	MAX BET	Cost to Cover	Denomination
10	1000	10	Denomination 1, 2
5	500	5	Denomination 3, 4, 5
5	100	5	Denomination 6, 7, 8

(Depends on the above Bet Configurations)



FREE GAMES FEATURE

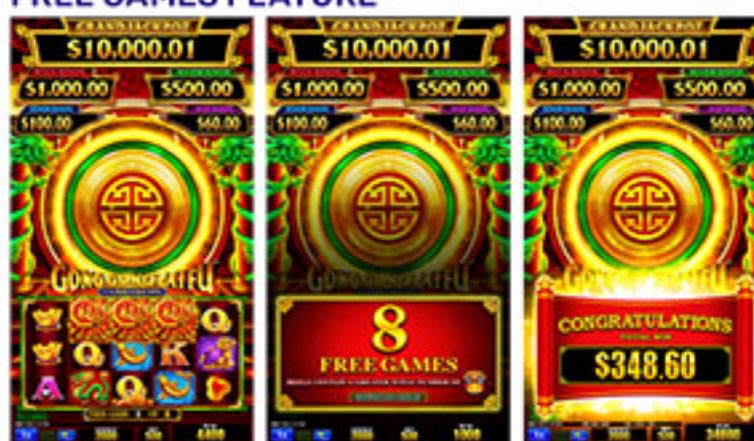

Any 3 appearing on reels 2, 3 and 4 trigger the FREE GAMES FEATURE with 8 free games.

Reels used during the FREE GAMES FEATURE contain a greater total number of .

FREE GAMES FEATURE can be triggered again during the FREE GAMES FEATURE.

FREE GAMES FEATURE starts after the GONG GONG LAI FU FEATURE ends if triggered in the same game.

If GONG GONG LAI FU FEATURE is triggered during the FREE GAMES FEATURE, any remaining free games resume after the GONG GONG LAI FU FEATURE ends.

GONG GONG LAI FU FEATURE



Any 6 or more trigger the GONG GONG LAI FU FEATURE and are held in position on the reels for the duration of the GONG GONG LAI FU FEATURE.

GONG GONG LAI FU FEATURE consists of 3 free spins.

During the GONG GONG LAI FU FEATURE, each symbol position becomes an individual spinning bonus reel.

In the GONG GONG LAI FU FEATURE, a prize map corresponding to the 15 symbol positions on the reels is displayed above the reels. Before the first free spin, each on the reels displays the prize from the corresponding location on the prize map. While a is held on the reels, the prize in the corresponding location on the prize map is also held. At the start of each free spin in GONG GONG LAI FU FEATURE, displayed prizes are redetermined for prize map squares that do not contain a held prize.

Each new appearing in a free spin displays a prize value that it is the sum of all held prizes displayed on the prize map from the previous free spin within the same GONG GONG LAI FU FEATURE only.

Each new appearing in a free spin resets the number of remaining free spins to 3 and is held in position for the duration of the GONG GONG LAI FU FEATURE. GONG GONG LAI FU FEATURE ends after all awarded free spins have been played or if appear in all 15 symbol positions. All prizes on Gong symbols are won at the end of feature.

JACKPOT SURPRISE



There is a chance that the GRAND JACKPOT is randomly won in bought games except when FREE GAMES FEATURE or GONG GONG LAI FU FEATURE is triggered.

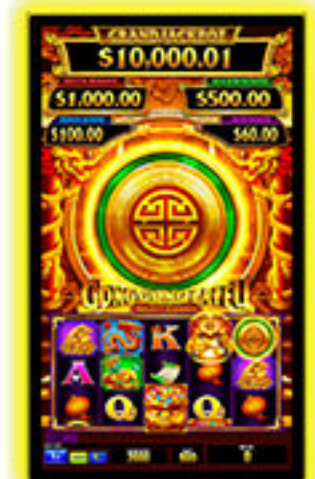

Also available in other Cabinet



TYPE OF PRODUCT

[LINK](#) / [SAP](#)

REEL CONFIGURATION

5-Reel 3-Row Video Slot

PAYLINES

10, 25, 50 Lines (Denomination 1, 2)
5, 10, 25 Lines (Denomination 3, 4, 5)
5 Lines (Denomination 6, 7, 8)

SA DENOMINATIONS

1	2	3	4	5	6	7	8
R0.01	R0.02	R0.05	R0.10	R0.20	R1	R2	R5
R0.05	R0.10	R0.25	R0.50	R1	R5	R10	R25
R0.10	R0.20	R0.50	R1	R2	R10	R20	R50
R0.50	R1	R2.50	R5	R10	R50	R100	R250
R1	R2	R5	R10	R20	R100	R200	R500

EU DENOMINATIONS

1	2	3	4	5	6	7	8
€0.01	€0.02	€0.05	€0.10	€0.20	€1	€2	€5
€0.05	€0.10	€0.25	€0.50	€1	€5	€10	€25
€0.10	€0.20	€0.50	€1	€2	€10	€20	€50
€0.50	€1	€2.50	€5	€10	€50	€100	€250
€1	€2	€5	€10	€20	€100	€200	€500

BET CONFIGURATIONS

1, 2, 3, 4, 5
1, 2, 3, 5, 8
1, 2, 3, 5, 10
1, 2, 5, 10, 20

MIN/MAX BET & Cost to Cover

MIN BET	MAX BET	Cost to Cover	Denomination
10	1000	10	Denomination 1, 2
5	500	5	Denomination 3, 4, 5
5	100	5	Denomination 6, 7, 8

(Depends on the above Bet Configurations)



FREE GAMES FEATURE

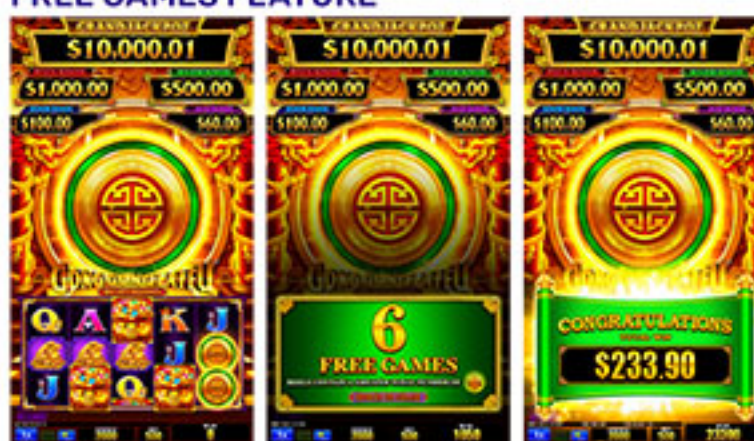

Any 3 appearing on reels 2, 3 and 4 trigger the FREE GAMES FEATURE with 6 free games.

Reels used during the FREE GAMES FEATURE contain a greater total number of .

FREE GAMES FEATURE can be triggered again during the FREE GAMES FEATURE.

FREE GAMES FEATURE starts after the GONG GONG LAI FU FEATURE ends if triggered in the same game.

If GONG GONG LAI FU FEATURE is triggered during the FREE GAMES FEATURE, any remaining free games resume after the GONG GONG LAI FU FEATURE ends.

GONG GONG LAI FU FEATURE



Any 6 or more trigger the GONG GONG LAI FU FEATURE and are held in position on the reels for the duration of the GONG GONG LAI FU FEATURE.

GONG GONG LAI FU FEATURE consists of 3 free spins.

During the GONG GONG LAI FU FEATURE, each symbol position becomes an individual spinning bonus reel.

In the GONG GONG LAI FU FEATURE, a prize map corresponding to the 15 symbol positions on the reels is displayed above the reels. Before the first free spin, each on the reels displays the prize from the corresponding location on the prize map. While a is held on the reels, the prize in the corresponding location on the prize map is also held. At the start of each free spin in GONG GONG LAI FU FEATURE, displayed prizes are redetermined for prize map squares that do not contain a held prize.

Each new appearing in a free spin displays a prize value that it is the sum of all held prizes displayed on the prize map from the previous free spin within the same GONG GONG LAI FU FEATURE only.

Each new appearing in a free spin resets the number of remaining free spins to 3 and is held in position for the duration of the GONG GONG LAI FU FEATURE. GONG GONG LAI FU FEATURE ends after all awarded free spins have been played or if appear in all 15 symbol positions. All prizes on Gong symbols are won at the end of feature.

JACKPOT SURPRISE



There is a chance that the GRAND JACKPOT is randomly won in bought games except when FREE GAMES FEATURE or GONG GONG LAI FU FEATURE is triggered.

Speed

Entertainment has a classy new look.
 Players can enjoy an exciting gaming experience.
 Optimal service design for accessibility and maintenance.

Stunning HD Graphics

An LCD monitor with dual 27-inch LCD high definition monitor.

Ergonomic button deck

Premium Speed 11.6-inch LCD Touch Screen panel with Bash Button.

Immersive Audio

Newly designed sound system creates powerful theater-like sound.

USB charging

USB charging port & wireless Charger also provided for player convenience.

DIMENSION

(Without Base Stand)

Upright Height

(Tower Light Included)

78.92 in (2004.5 mm)

Upright Height

(Tower Light Excluded)

74.67 in (1896.5 mm)

Width

26.77 in (680 mm)

Depth

24.82 in (630.5 mm)

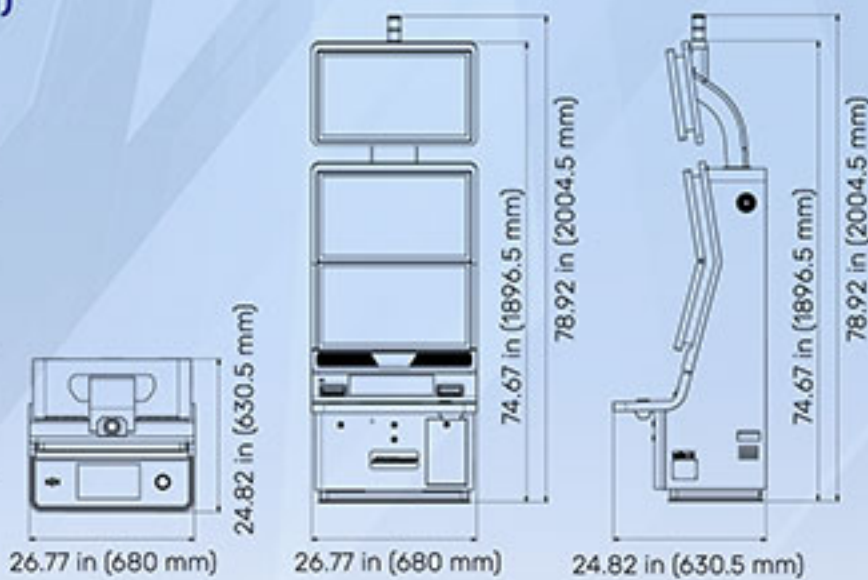

DIMENSION

(With Custom Base Stand)

Upright Height

(Tower Light Included)

96.92 in (2461.7 mm)

Upright Height

(Tower Light Excluded)

92.67 in (2353.7 mm)

Width

26.77 in (680 mm)

Depth

24.84 in (631 mm)

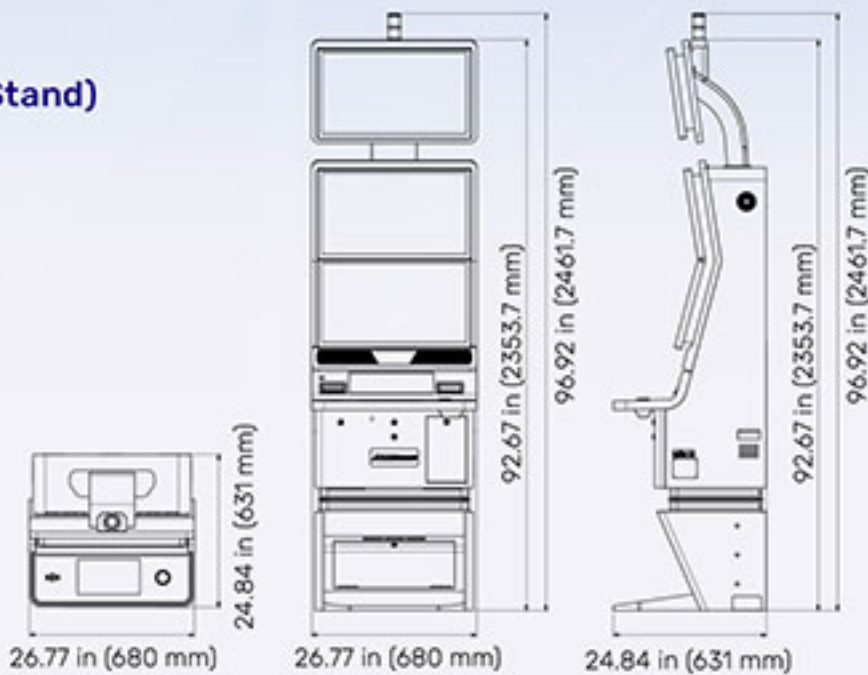

Please contact your Account Executive for more details.

sales@aruzeglobal.com

+1 702-781-8080

www.aruzeglobal.com

Follow us @AruzeGaming



Empire Technological Group Ltd dba
 Aruze Gaming Global

FORTUNE FRAME™



Boost your game
play with random
frames for a chance
at the jackpot!



Collect more for more prizes. Random appearing in any symbol position boost your excitement. In Cash Spin, each spin awards prizes or an additional +1 spin. In Free Games, WILD randomly appear, becoming a multiplier and granting even bigger wins. GRAND JACKPOT or MAJOR JACKPOT can also be randomly won in bought games.

CASH SPIN



FREE GAMES

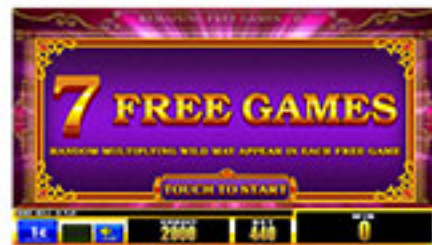

JACKPOT SURPRISE



Also available in other Cabinet



TYPE OF PRODUCT

[LINK](#) / [SAP](#)

REEL CONFIGURATION

5-Reel 3-Row Video Slot

PAYLINES

243 Ways

SA DENOMINATIONS

1	2	3	4	5	6
R0.01	R0.02	R0.05	R0.10	R1	R2
R0.02	R0.05	R0.10	R0.20	R0.50	R1
R0.05	R0.10	R0.20	R0.50	R1	R2
R0.05	R0.10	R0.20	R0.50	R1	R10
R0.10	R0.20	R0.50	R1	R2	R5
R0.20	R0.50	R1	R2	R5	R10
R0.50	R1	R2	R5	R10	R20
R1	R2	R5	R10	R20	R50
R2	R5	R10	R20	R100	R200
R10	R20	R50	R100	R500	R1000

EU DENOMINATIONS

1	2	3	4	5	6
€0.01	€0.02	€0.05	€0.10	€1	€2
€0.02	€0.05	€0.10	€0.20	€0.50	€1
€0.05	€0.10	€0.20	€0.50	€1	€2
€0.05	€0.10	€0.20	€0.50	€1	€10
€0.10	€0.20	€0.50	€1	€2	€5
€0.20	€0.50	€1	€2	€5	€10
€0.50	€1	€2	€5	€10	€20
€1	€2	€5	€10	€20	€50
€2	€5	€10	€20	€100	€200
€10	€20	€50	€100	€500	€1000

BET CONFIGURATIONS

- 1, 2, 3, 4, 5
- 1, 2, 3, 4, 6
- 1, 2, 3, 5, 10
- 1, 2, 3, 6, 10
- 1, 2, 5, 10, 20

MIN/MAX BET & Cost to Cover

MIN BET	MAX BET	Cost to Cover
8	160	8
18	360	18
38	760	38
68	1360	68
88	1760	88

(Depends on the above Bet Configurations)



Collect more for more prizes. Random appearing in any symbol position boost your excitement. In Cash Spin, each spin awards prizes or an additional +1 spin. In Free Games, extra WILD appear granting even bigger wins. GRAND JACKPOT or MAJOR JACKPOT can also be randomly won in bought games.

CASH SPIN



FREE GAMES



JACKPOT SURPRISE



COIN COLLECTOR™

Unlock greater
riches with golden
coins!





Dive into the captivating world of ancient Egypt as you take on an adventure with powerful deities in search of golden treasures. Test your luck with the Dream Collector feature to gather abundant coins, and enjoy exciting Free Games for a chance to win big rewards. Will you venture the deserts and claim the riches of the Gods?

FREE GAMES FEATURE

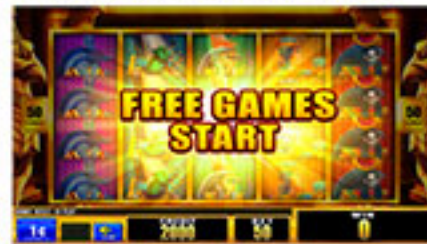

DREAM COLLECTOR



JACKPOT SURPRISE



TYPE OF PRODUCT

[LINK](#) / [SAP](#)

REEL CONFIGURATION

5-Reel 4-Row Video Slot

PAYLINES

50 Lines

25 Lines

4 Lines (Denomination 4, 5, 6 only)

SA DENOMINATIONS

1	2	3	4	5	6
R0.01	R0.02	R0.05	R0.10	R1	R2
R0.05	R0.10	R0.25	R0.50	R5	R10
R0.10	R0.20	R0.50	R1	R10	R20
R0.50	R1	R2.50	R5	R50	R100
R1	R2	R5	R10	R100	R200

EU DENOMINATIONS

1	2	3	4	5	6
€0.01	€0.02	€0.05	€0.10	€1	€2
€0.05	€0.10	€0.25	€0.50	€5	€10
€0.10	€0.20	€0.50	€1	€10	€20
€0.50	€1	€2.50	€5	€50	€100
€1	€2	€5	€10	€100	€200

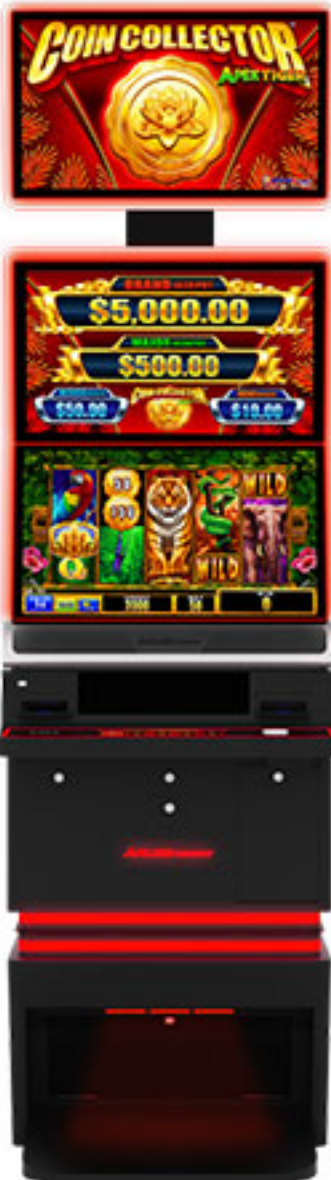

Embark on an exhilarating adventure through the jungle, where you become the hunter of the wild. Test your luck with the Dream Collector feature to gather mysterious treasures, and unlock exciting Free Games for a chance to win big rewards. Can you conquer the wild and reign victorious?

FREE GAMES FEATURE



DREAM COLLECTOR



JACKPOT SURPRISE



BET CONFIGURATIONS

1, 2, 3, 4, 5

1, 2, 3, 5, 6

1, 2, 3, 5, 8

1, 2, 3, 5, 10

MIN/MAX BET & Cost to Cover

MIN BET	MAX BET	Cost to Cover	Denomination
50	500	50	All Denominations
25	250	25	All Denominations
4	40	4	Denomination 4, 5, 6

(Depends on the above Bet Configurations)



Unlock greater riches with golden coins! Jackpot, bonus and credit prizes on gold coins are won when appearing in any position on 3 or more consecutive reels beginning with the leftmost reel. More coins appear on the first three reels during free games and even more coins appear on all reels in a respin that is triggered randomly when wild appears during bought games.

5 GUARDIANS FEATURE



MYSTERY SYMBOL



DREAM COLLECTOR



JACKPOT SURPRISE



TYPE OF PRODUCT

[LINK](#) / [SAP](#)

REEL CONFIGURATION

5-Reel 4-Row Video Slot

PAYLINES

50 Lines

25 Lines

4 Lines (Denomination 4, 5, 6 only)

SA DENOMINATIONS

1	2	3	4	5	6
R0.01	R0.02	R0.05	R0.10	R1	R2
R0.05	R0.10	R0.25	R0.50	R5	R10
R0.10	R0.20	R0.50	R1	R10	R20
R0.50	R1	R2.50	R5	R50	R100
R0.02	R0.05	R0.10	R0.20	R2	R5
R0.20	R0.50	R1	R2	R20	R50
R0.01	R0.02	R0.05	R0.10		
R0.10	R0.20	R0.50	R1		
R0.50	R1	R2.50	R5		
R1	R2	R5	R10		
R5	R10	R25	R50		
R10	R20	R50	R100		
R0.02	R0.05	R0.10	R0.20		
R0.20	R0.50	R1	R2		

EU DENOMINATIONS

1	2	3	4	5	6
€0.01	€0.02	€0.05	€0.10	€1	€2
€0.05	€0.10	€0.25	€0.50	€5	€10
€0.10	€0.20	€0.50	€1	€10	€20
€0.50	€1	€2.50	€5	€50	€100
€0.02	€0.05	€0.10	€0.20	€2	€5
€0.20	€0.50	€1	€2	€20	€50
€0.01	€0.02	€0.05	€0.10		
€0.10	€0.20	€0.50	€1		
€0.50	€1	€2.50	€5		
€1	€2	€5	€10		
€5	€10	€25	€50		
€10	€20	€50	€100		
€0.02	€0.05	€0.10	€0.20		
€0.20	€0.50	€1	€2		

BET CONFIGURATIONS

1, 2, 3, 4, 5

1, 2, 3, 5, 10

MIN/MAX BET & Cost to Cover

MIN BET	MAX BET	Cost to Cover	Denomination
50	500	50	All Denomination
25	250	25	All Denomination
4	40	4	Denomination 4, 5, 6

(Depends on the above Bet Configurations)

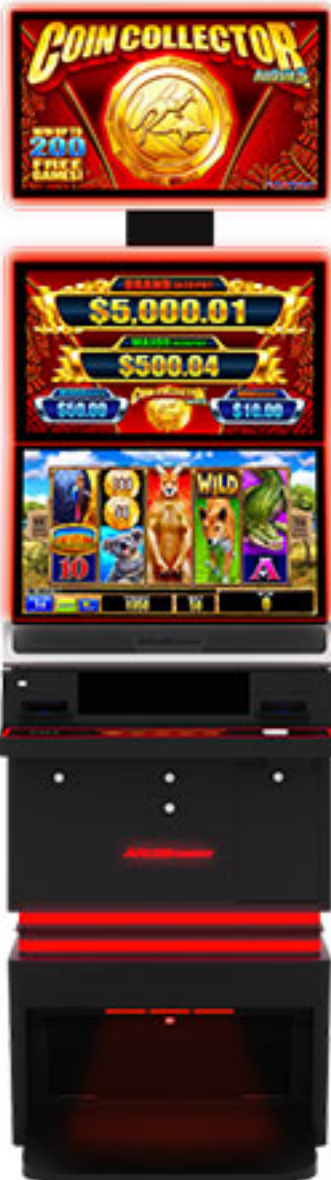

Unlock greater riches with golden coins! Jackpot, bonus and credit prizes on gold coins are won when appearing in any position on 3 or more consecutive reels beginning with the leftmost reel. More coins appear on the first three reels during free games and even more coins appear on all reels in a respin that is triggered randomly when wild appears during bought games.

5 GUARDIANS FEATURE



MYSTERY SYMBOL



DREAM COLLECTOR



JACKPOT SURPRISE



FU LAI CAI LAI 福来财来™

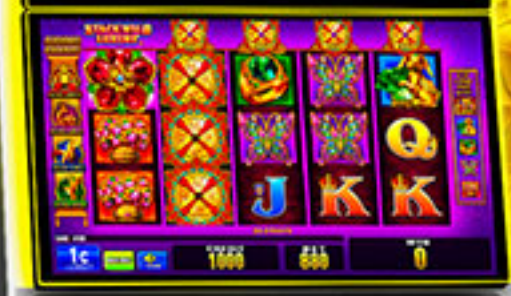



Experience an enriching variety of gameplay and surprising riches. Increasing the bet level and credit per play improve several elements of gameplay.



TYPE OF PRODUCT

LINK / SAP

REEL CONFIGURATION

5-Reel 3-Row Video Slot

PAYLINES

243 Ways

DENOMINATIONS

SA R0.10

EU €0.01

BET CONFIGURATIONS

1, 2, 3, 6, 10

MIN/MAX BET & Cost to Cover

MIN BET	MAX BET	Cost to Cover	BET LEVEL
11	110	11	Bet Level 1
33	330	33	Bet Level 2
55	550	55	Bet Level 3
66	660	66	Bet Level 4
88	880	88	Bet Level 5

(Depends on the above Bet Configurations)

FU LAI CAI LAI TRIPLE FESTIVAL

appearing on 3 or more consecutive reels beginning with the leftmost reel trigger the FREE GAMES FEATURE with 8 FREE GAMES. During FREE GAMES FEATURE, reels contains Picture symbols only. FREE GAMES FEATURE can be triggered again during the FREE GAMES FEATURE.

If the FREE GAMES FEATURE is triggered in the same game as the JACKPOT FEATURE, the FREE GAMES FEATURE starts after the JACKPOT FEATURE ends.

FU LAI CAI LAI 5 SEA LEGENDS

appearing on 3 or more consecutive reels beginning with the leftmost reel trigger the FREE GAMES FEATURE with 6 FREE GAMES.

Before FREE GAMES start, select 1 of the symbols from the available options.

If the FREE GAMES FEATURE was triggered when playing bet level 2 or higher, the reels used during the FREE GAMES are composed with the following symbols only: the symbol selected from the available options,

and .

If the FREE GAMES FEATURE was triggered when playing bet level 1, the reels used during the FREE GAMES are composed with the following symbols only: the symbol selected from the available options, and .

and .

During the FREE GAMES, appearing on 3 or more consecutive reels beginning with the leftmost reel award an additional 6 FREE GAMES, however the selection of the symbol option is not made again.

If the FREE GAMES FEATURE is triggered in the same game as the JACKPOT FEATURE, the FREE GAMES FEATURE starts after the JACKPOT FEATURE ends.

FU LAI CAI LAI STACK WILD LUXURY

appearing on 3 or more consecutive reels beginning with the leftmost reel trigger the FREE GAMES FEATURE with 8 FREE GAMES.

During the FREE GAMES, all symbols on 1 or more reels (reels 2, 3, 4 and 5 according to bet level played) may randomly become .

FREE GAMES FEATURE cannot be triggered again during the FREE GAMES FEATURE.

If the FREE GAMES FEATURE is triggered in the same game as the JACKPOT FEATURE, the FREE GAMES FEATURE starts after the JACKPOT FEATURE ends.

GAME TITLES:



JACKPOT FEATURE

The JACKPOT FEATURE can be triggered when playing bet level 2, 3, 4 or 5 only. There is a chance the JACKPOT FEATURE may be triggered when appears.

Alternatively, the JACKPOT FEATURE is triggered when the large drops down to be displayed on the game screen randomly in bought games and free games.

According to the bet level played, up to 4 jackpot levels may be available. In the JACKPOT FEATURE, select from 15 ingots until 3 matching symbols corresponding to a jackpot level are revealed.

If 3 are revealed, an additional JACKPOT FEATURE is awarded and the feature continues until a jackpot level is won.

When 3 matching jackpot level symbols have been revealed, the corresponding jackpot level is won and the JACKPOT FEATURE ends. Any additional JACKPOT FEATURE awarded, starts after the preceding JACKPOT FEATURE ends.

WILD COIN BONUS

There is a chance the WILD COIN BONUS may occur when 1 or more appear on the reels in a bought game or free game. When the WILD COIN BONUS occurs, a special credit prize displayed on the game screen is awarded. Special Credit Prize: total credits bet multiplied by either 10, 20, 30, 50 or 100 randomly as displayed.

FORTUNE DRUMS™





Spinning riches stir up excitement. Picture symbols are increased on reels according to the credits bet played. Special reels comprised exclusively of Picture, "Feature" and "Wild" symbols are used during the 10 Free Games. In DON DON DON, a big win awaits as either a bonus credit prize or 1 of 4 progressive levels is won.

FREE GAMES

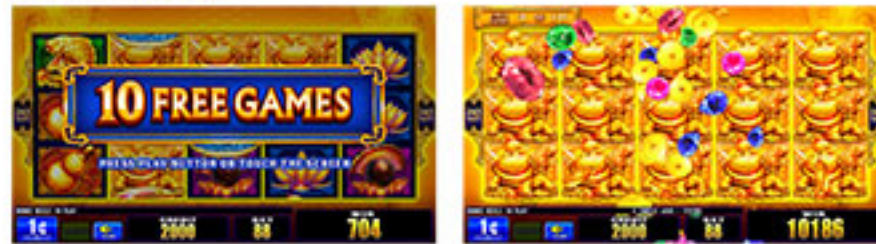

DON DON DON

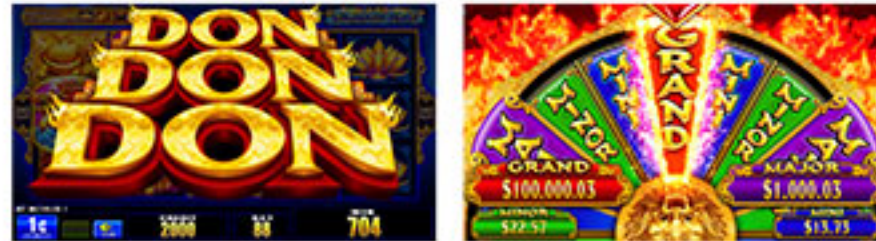

TYPE OF PRODUCT

LINK / **SAP**

REEL CONFIGURATION

5-Reel 3-Row Video Slot

PAYLINES

243 Ways

DENOMINATIONS

SA R0.10

EU €0.01

BET CONFIGURATIONS

1, 2, 3, 4, 5

1, 2, 3, 5, 10

1, 2, 5, 10, 15

1, 2, 5, 10, 20

MIN/MAX BET & Cost to Cover

MIN BET	MAX BET	Cost to Cover	BET LEVEL
8	160	8	Bet Level 1
18	360	18	Bet Level 2
38	760	38	Bet Level 3
68	1360	68	Bet Level 4
88	1760	88	Bet Level 5

(Depends on the above Bet Configurations)



Spinning riches stir up excitement. Picture symbols are increased on reels according to the credits bet played. When the feature is triggered a Mini Game occurs, improving the reels used during 6 Free Games. In DON DON DON, a big win awaits as either a bonus credit prize or 1 of 4 progressive levels is won.

FREE GAMES

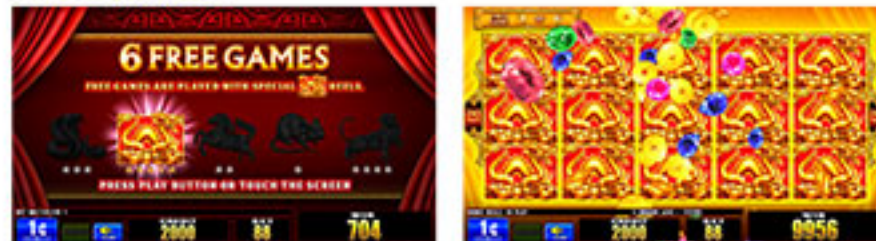

DON DON DON

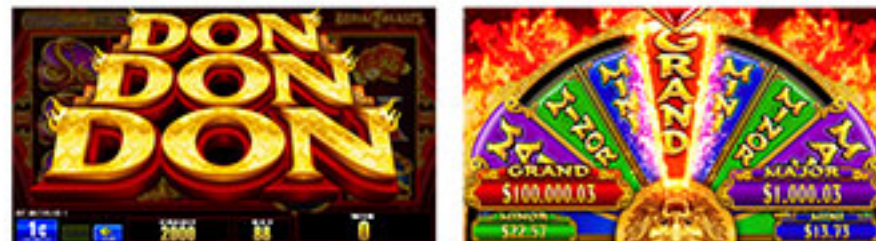

TYPE OF PRODUCT

LINK / **SAP**

REEL CONFIGURATION

5-Reel 3-Row Video Slot

PAYLINES

243 Ways

DENOMINATIONS

SA R0.10

EU €0.01

BET CONFIGURATIONS

1, 2, 3, 4, 5

1, 2, 3, 5, 10

1, 2, 5, 10, 15

1, 2, 5, 10, 20

MIN/MAX BET & Cost to Cover

MIN BET	MAX BET	Cost to Cover	BET LEVEL
8	160	8	Bet Level 1
18	360	18	Bet Level 2
38	760	38	Bet Level 3
68	1360	68	Bet Level 4
88	1760	88	Bet Level 5

(Depends on the above Bet Configurations)



Spinning riches stir up excitement. Picture symbols are increased on reels according to the credits bet played. 3 symbols held on reel 3 are used during 10 Free Games. In DON DON DON, a big win awaits as either a bonus credit prize or 1 of 4 progressive levels is won.

FREE GAMES

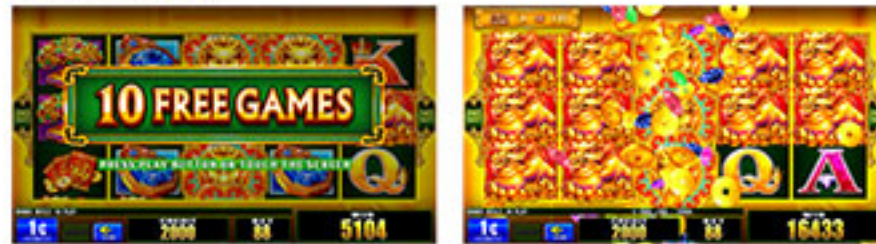

DON DON DON

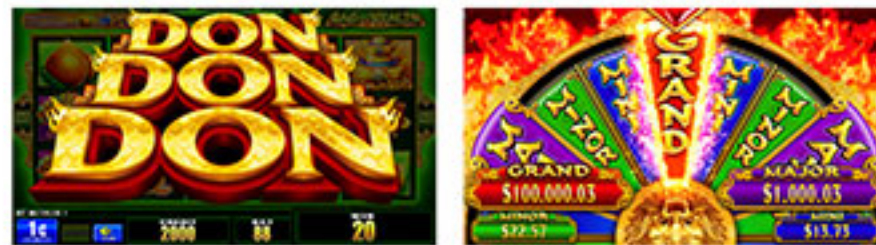

TYPE OF PRODUCT

LINK / SAP

REEL CONFIGURATION

5-Reel 3-Row Video Slot

PAYLINES

243 Ways

DENOMINATIONS

SA R0.10

EU €0.01

BET CONFIGURATIONS

1, 2, 3, 4, 5

1, 2, 3, 5, 10

1, 2, 5, 10, 15

1, 2, 5, 10, 20

MIN/MAX BET & Cost to Cover

MIN BET	MAX BET	Cost to Cover	BET LEVEL
8	160	8	Bet Level 1
18	360	18	Bet Level 2
38	760	38	Bet Level 3
68	1360	68	Bet Level 4
88	1760	88	Bet Level 5

(Depends on the above Bet Configurations)



Spinning riches stir up excitement. Picture symbols are increased on reels according to the credits bet played. Special reels with consecutive wild symbols and no Royal symbols are used during the 8 Free Games. In DON DON DON, a big win awaits as either a bonus credit prize or 1 of 4 progressive levels is won.

FREE GAMES

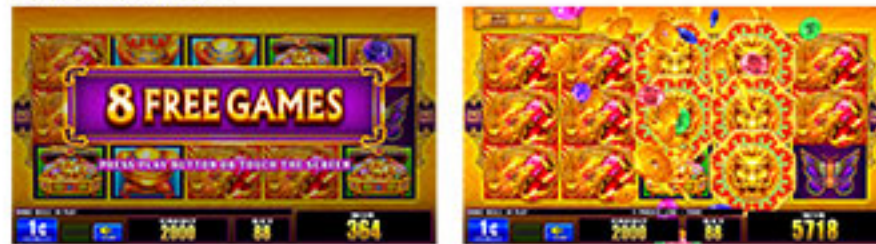

DON DON DON

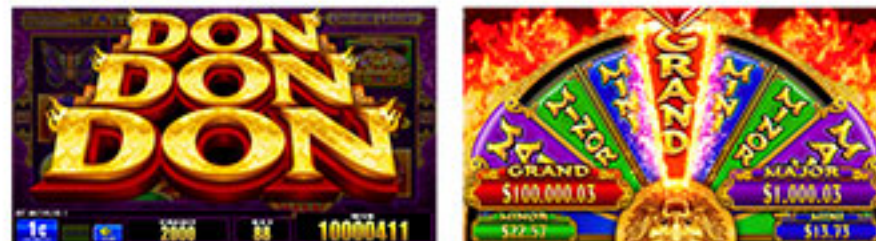

TYPE OF PRODUCT

LINK / SAP

REEL CONFIGURATION

5-Reel 3-Row Video Slot

PAYLINES

243 Ways

DENOMINATIONS

SA R0.10

EU €0.01

BET CONFIGURATIONS

1, 2, 3, 4, 5

1, 2, 3, 5, 10

1, 2, 5, 10, 15

1, 2, 5, 10, 20

MIN/MAX BET & Cost to Cover

MIN BET	MAX BET	Cost to Cover	BET LEVEL
8	160	8	Bet Level 1
18	360	18	Bet Level 2
38	760	38	Bet Level 3
68	1360	68	Bet Level 4
88	1760	88	Bet Level 5

(Depends on the above Bet Configurations)

BOMB COLLECTOR™



**Ignite the
bombs to trigger
explosive features!**



Ignite the bombs to trigger explosive features! When bombs explode, they can trigger one of the explosive features: WILD BOOM, PRIZE BLAST, FREE GAMES EXPLOSION and JACKPOT FEATURE. More Jackpots can be also won when wild appears: GRAND, MAJOR, MINOR, MINI.

WILD BOOM



PRIZE BLAST



FREE GAMES EXPLOSION



JACKPOT FEATURE



TYPE OF PRODUCT

[LINK](#) / [SAP](#)

REEL CONFIGURATION

5-Reel 3-Row Video Slot

PAYLINES

30 Lines

DENOMINATIONS

SA R0.10

EU €0.01

BET CONFIGURATIONS

1, 2, 3, 4, 5, 6, 7, 8, 9, 10

MIN/MAX BET & Cost to Cover

MIN BET	MAX BET	Cost to Cover
88	880	88

(Depends on the above Bet Configurations)



Ignite the bombs to trigger explosive features! When bomb explode it may awards one of the following prizes: WILD BOOM, PRIZE BLAST, FREE GAMES EXPLOSION and JACKPOT FEATURE. When wild appears it may also awards 1 of the Jackpots: GRAND, MAJOR, MINOR, MINI.

WILD BOOM



PRIZE BLAST

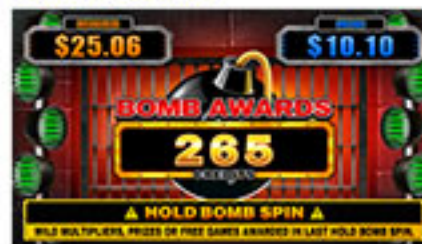

FREE GAMES EXPLOSION



JACKPOT FEATURE



TYPE OF PRODUCT

[LINK](#) / [SAP](#)

REEL CONFIGURATION

5-Reel 3-Row Video Slot

PAYLINES

30 Lines

DENOMINATIONS

SA R0.10

EU €0.01

BET CONFIGURATIONS

1, 2, 3, 4, 5, 6, 7, 8, 9, 10

MIN/MAX BET & Cost to Cover

MIN BET	MAX BET	Cost to Cover
88	880	88

(Depends on the above Bet Configurations)

COIN COIN

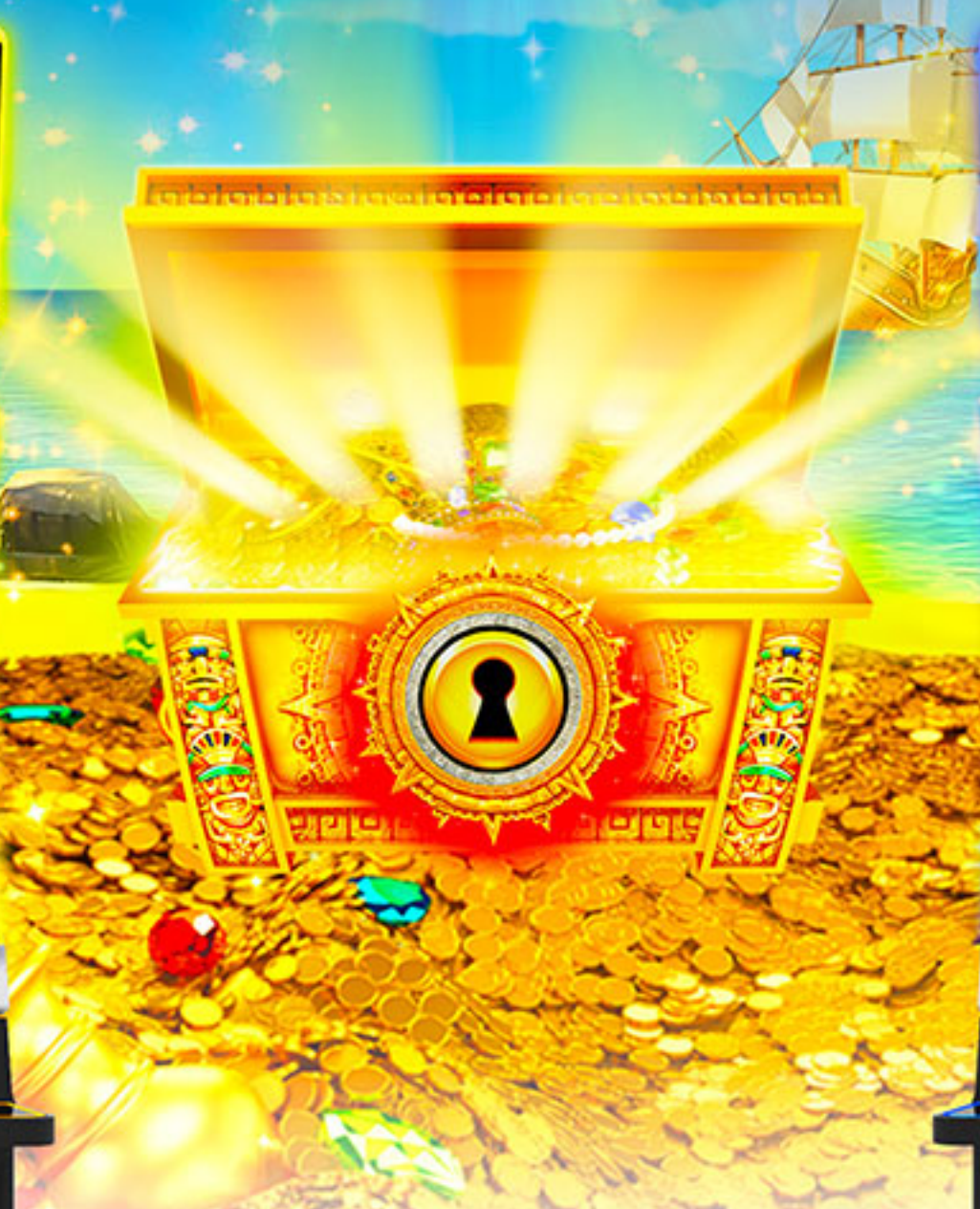

Wild keys
of fortune possess
the power to unlock
golden riches!



Wild keys of fortune possess the power to unlock golden riches. Jackpot, bonus and credit prizes on gold coins are won when appearing in any position on 3 or more consecutive reels beginning with the leftmost reel. More coins appear on the first three reels during free games and even more coins appear on all reels in a respin that is triggered randomly when wild appears during bought games.

FREE GAMES



TREASURE RESPIN



JACKPOT AND BONUS PRIZES



TYPE OF PRODUCT

[LINK](#) / [SAP](#)

REEL CONFIGURATION

5-Reel 3-Row Video Slot

PAYLINES

243 Ways

SA DENOMINATIONS

1	2	3	4	5	6
R0.01	R0.02	R0.05	R0.10	R1	R2
R0.05	R0.10	R0.25	R0.50	R5	R10
R0.10	R0.20	R0.50	R1	R10	R20
R0.50	R1	R2.50	R5	R50	R100
R1	R2	R5	R10	R100	R200
R0.01	R0.02	R0.05	R0.10		
R0.02	R0.05	R0.10	R0.20		
R0.05	R0.10	R0.25	R0.50		
R0.10	R0.20	R0.50	R1		
R0.20	R0.50	R1	R2		
R0.50	R1	R2.50	R5		
R1	R2	R5	R10		
R5	R10	R25	R50		
R10	R20	R50	R100		

EU DENOMINATIONS

1	2	3	4	5	6
€0.01	€0.02	€0.05	€0.10	€1	€2
€0.05	€0.10	€0.25	€0.50	€5	€10
€0.10	€0.20	€0.50	€1	€10	€20
€0.50	€1	€2.50	€5	€50	€100
€1	€2	€5	€10	€100	€200
€0.01	€0.02	€0.05	€0.10		
€0.02	€0.05	€0.10	€0.20		
€0.05	€0.10	€0.25	€0.50		
€0.10	€0.20	€0.50	€1		
€0.20	€0.50	€1	€2		
€0.50	€1	€2.50	€5		
€1	€2	€5	€10		
€5	€10	€25	€50		
€10	€20	€50	€100		

BET CONFIGURATIONS

- 1, 2, 3, 4, 5
- 1, 2, 3, 5, 8
- 1, 2, 3, 5, 10
- 1, 2, 5, 10, 20

MIN/MAX BET & Cost to Cover

MIN BET	MAX BET	Cost to Cover	Denomination
10	1000	50	Denomination 1, 2
5	500	25	Denomination 3, 4
1	100	5	Denomination 5, 6

(Depends on the above Bet Configurations)



Wild keys of fortune possess the power to unlock golden riches. Jackpot, bonus and credit prizes on gold coins are won when appearing in any position on 3 or more consecutive reels beginning with the leftmost reel. More coins appear on the first three reels during free games and even more coins appear on all reels in a respin that is triggered randomly when wild appears during bought games.

FREE GAMES



TREASURE RESPIN



JACKPOT AND BONUS PRIZES



GONG GONG LAIFU™



**The sound
of the Gong brings
good fortune!**



The sound of the Gong brings good fortune. A new set of reels will appear during Gong Gong Lai Fu Feature, awarding Credit prizes or Bonuses. Each Gong symbol appearing is held for the entire Feature and adds to the prizes shown on top of the reels. Grand Jackpot can be won when all 15 Gong symbols are collected during Gong Gong Lai Fu Feature or as Jackpot Surprise during the bought games.

GONG GONG LAI FU FEATURE



FREE GAMES FEATURE

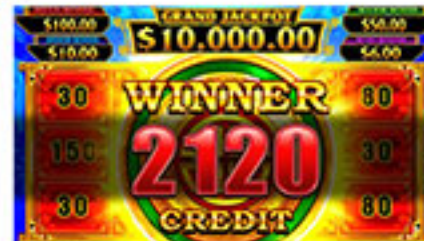

JACKPOT SURPRISE



Also available in other Cabinet



TYPE OF PRODUCT

[LINK](#) / [SAP](#)

REEL CONFIGURATION

5-Reel 3-Row Video Slot

PAYLINES

10, 25, 50 Lines (Denomination 1, 2)
5, 10, 25 Lines (Denomination 3, 4, 5)
5 Lines (Denomination 6, 7, 8)

SA DENOMINATIONS

1	2	3	4	5	6	7	8
R0.01	R0.02	R0.05	R0.10	R0.20	R1	R2	R5
R0.05	R0.10	R0.25	R0.50	R1	R5	R10	R25
R0.10	R0.20	R0.50	R1	R2	R10	R20	R50
R0.50	R1	R2.50	R5	R10	R50	R100	R250
R1	R2	R5	R10	R20	R100	R200	R500

EU DENOMINATIONS

1	2	3	4	5	6	7	8
€0.01	€0.02	€0.05	€0.10	€0.20	€1	€2	€5
€0.05	€0.10	€0.25	€0.50	€1	€5	€10	€25
€0.10	€0.20	€0.50	€1	€2	€10	€20	€50
€0.50	€1	€2.50	€5	€10	€50	€100	€250
€1	€2	€5	€10	€20	€100	€200	€500

BET CONFIGURATIONS

1, 2, 3, 4, 5
1, 2, 3, 5, 8
1, 2, 3, 5, 10
1, 2, 5, 10, 20

MIN/MAX BET & Cost to Cover

MIN BET	MAX BET	Cost to Cover	Denomination
10	1000	50	Denomination 1, 2
5	500	25	Denomination 3, 4, 5
1	100	5	Denomination 6, 7, 8

(Depends on the above Bet Configurations)



The sound of the Gong brings good fortune. A new set of reels will appear during Gong Gong Lai Fu Feature, awarding Credit prizes or Bonuses. Each Gong symbol appearing is held for the entire Feature and adds to the prizes shown on top of the reels. Grand Jackpot can be won when all 15 Gong symbols are collected during Gong Gong Lai Fu Feature or as Jackpot Surprise during the bought games.

GONG GONG LAI FU FEATURE

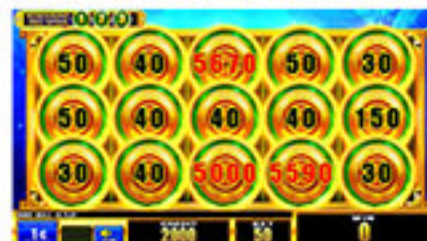

FREE GAMES FEATURE



JACKPOT SURPRISE



Speed

LIMITED PAYOUT MACHINES

Gambling machines with a restricted bet and prize.





TYPE OF PRODUCT

Multi Game

REEL CONFIGURATION

5-Reel 3-Row Video Slot

PAYLINES

5 Lines

DENOMINATIONS

R1

BET CONFIGURATIONS

1, 2, 3, 4, 5

MAX BET

R5



SLOT GAMES are triggered when 3 or more scattered appear, each triggers 2, 3, 5, 7, 8, 10, 12, 20, 25, 30 or 50 SLOT GAMES as displayed on the symbol. In each SLOT GAME, 3 special reels on the top screen are spun. The numbers that appear on the reels form the numerical value of the prize won shown in R.



The number of SLOT GAMES (SG) listed on the paytable is triggered when the corresponding winning symbol combination appears. In each SLOT GAME, 3 special reels on the top screen are spun. 3 or more scattered trigger 8 PENNY GAMES. At the start of each PENNY GAME, all on the reels become the same symbol.

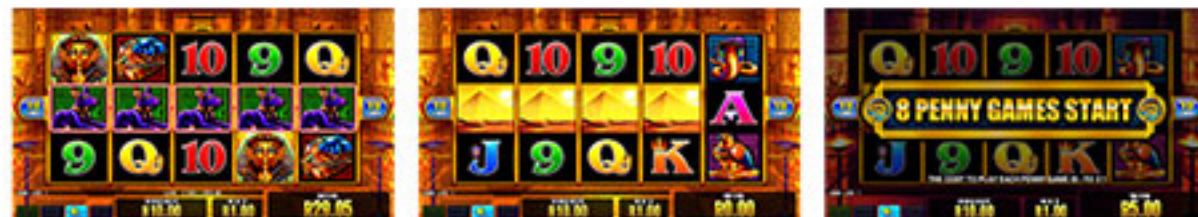

Any 3 or more trigger 10 PENNY GAMES. During the PENNY GAMES, any 3 or more award 10 additional penny games. The number of ACTION GAMES (AG) listed on the paytable is triggered when the corresponding winning symbol combination appears. Each ACTION GAME results in either a R10 win, 6 additional ACTION GAMES (AG) awarded or no win ().

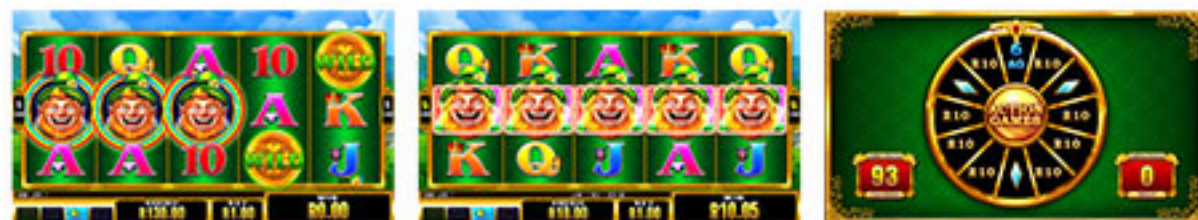

Any 3 or more trigger 8 PENNY GAMES. During the PENNY GAMES, any 3 or more award 8 additional penny games. The number of ACTION GAMES (AG) listed on the paytable is triggered when the corresponding winning symbol combination appears. Each ACTION GAME results in 1 of the following: R2, R5, R8, R10 or R12 multiplied by R bet as displayed is won; 6 AG: awards 6 additional ACTION GAMES (AG); : no win.





ARUZE
iINTERACTIVE-

Whether you are at home
or on the go, you can always
locate your favorite
AG2 games!

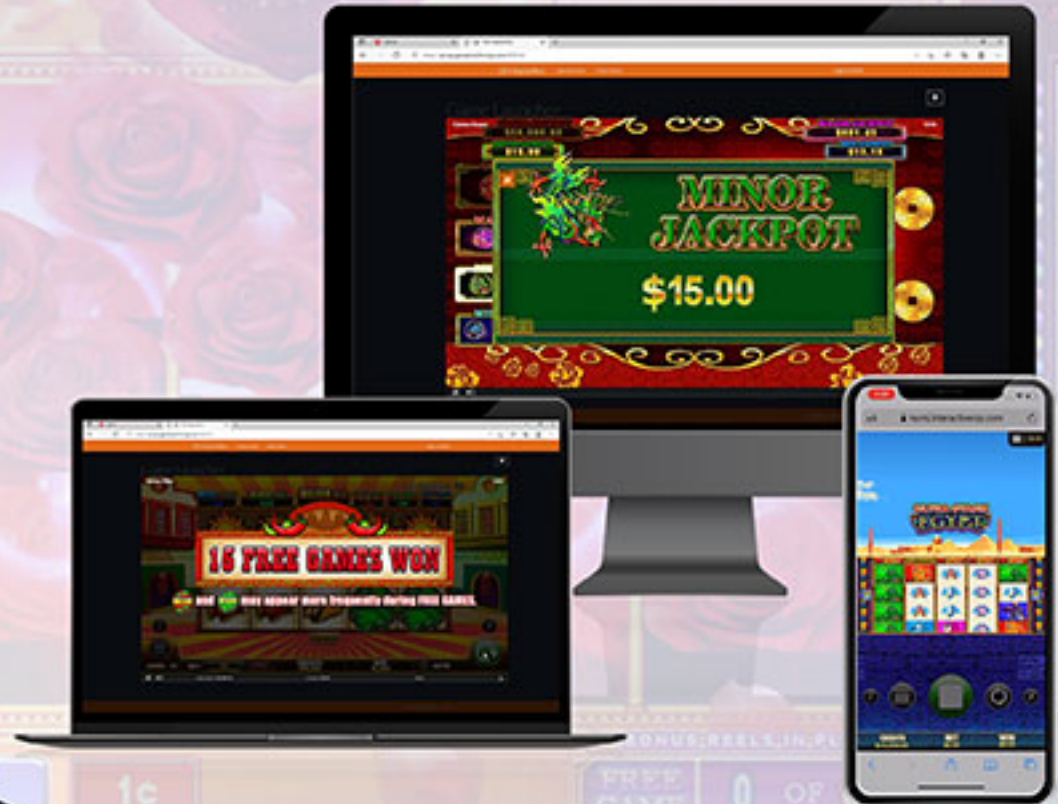

Zynga - HIT IT RICH



LUCKY NORTH CASINO



BEST BET CASINO



SUPER LUCKY CASINO



TROPWORLD CASINO



GSN - WHEEL OF FORTUNE



MAGICIAN CASINO 2



Elevate the *Game*



ARUZEGAMING™ GLOBAL

Aruze Gaming Global Europe B.V.

Melkrijder 16, 3861 SG Nijkerk, The Netherlands

TEL: +1 702-781-8080

EMAIL: EUsales@aruzeglobal.com

Aruze Gaming Global HQ

1106 Palms Airport Dr Las Vegas, NV 89119

TEL: +1 702-781-8080

EMAIL: info@aruzeglobal.com

Customer Technical Support

Available 24 hours a day / 7 days a week

TEL: +1 877-438-0569

EMAIL: FieldServiceSupport@aruzeglobal.com

Aruze Gaming Global Central Office

10447 Lemoyne Blvd Biloxi, MS 39532

TEL: +1 702-781-8080

Empire Shared Services Philippines, Inc - Makati

Unit 1115-1116, 11th Floor, Tower One & Exchange Plaza, Ayala Avenue cor. Paseo de Roxas, Bel Air, Makati, Philippines

Empire Shared Services Philippines, Inc - Alabang

5th Floor, Southkey Hub 1, Indo-China Drive, Northgate Cyberzone, Filinvest City 1780, Alabang, Muntinlupa, Philippines

Aruze Gaming Africa PTY LTD.

P.O. Box 11484, Vorna Valley 1684 Unit 1/2/3 Kyalami Village 57 Forrsmen Close, Barbeque Downs Ext. 1 Kyalami, Midrand, Gauteng, South Africa

TEL: +27 11-466-3388 FAX: +27 11-466-3389

EMAIL: sales@aruzegaming.co.za

Aruze Gaming Australia PTY LTD.

Unit 5, 10 Tollis Place, Seven Hills, NSW 2164 Australia

TEL: +61 2-8332-6000

EMAIL: sales@aruzegaming.com.au

Empire Technological Group Limited - Macau Branch

Avenida Xian Xing Hai, No.105, Centro Golden Dragon, 11 Andar N, Macau

TEL: +1 853-2881-2381

EMAIL: asiainfo@aruzeglobal.com

Empire Technological Group Japan K.K

1-2-7, Kandasudacho Awajichouekimae Bldg. 3F, Chiyoda-Ku, Tokyo, 101-0041 Japan

CONFIDENTIAL

For Aruze Customer's Internal use only
Do Not Otherwise Reproduce or Disclose

Follow us @AruzeGaming



www.aruzeglobal.com