



**AG2**

**G2E Las Vegas 2024**

Product Catalog



**MUSO™**  
**SUMMIT**

*Elevate*  
*the Game*

A blue arrow pointing upwards and to the right, with a blue swoosh underneath it.



# CONTENTS

## MUSO SUMMIT

---

MUSO SUMMIT Without Stand (Cabinet Feature)	4
MUSO SUMMIT With Stand (Cabinet Feature)	5
MUSO SUMMIT BANK With Stand (Cabinet Feature)	6
Horrorific! Series	7
Horrorific! Monster Lab	8
Horrorific! Monster Forest	9
Horrorific! Monster Castle	10
Horrorific! Monster Crypt	11
Cash Master Blaster Series	12
Cash Master Blaster Treasure Hunt	13
Cash Master Blaster Gold Hunt	14
Mr. Series	15
Mr. Caliente's Dance Party	16
Mr. Dig-me a Winner	17
Mystery of Fantastic Dragons Series	18
Mystery of Fantastic Dragons Inferno	19
Mystery of Fantastic Dragons Lightning	20
Devil Panda and Wicked Panda	21
Devil Panda	22
Wicked Panda	23

## MUSO CURVE-55 HYBRID

---

MUSO CURVE-55 Hybrid (Cabinet Feature)	24
Triple Treasure Pot Series	25
Triple Treasure Pot Eternal Prosperity	26
Triple Treasure Pot Heavenly Wealth	27
Long Fu Zhu Series	28
Long Fu Zhu Mongol Storm	29
Long Fu Zhu Panda Strike	30
Xin Yun Qiu Series	31
Xin Yun Qiu Dragon	32
Xin Yun Qiu Lion	33
Bingo Jackpot Series	34
Bingo Jackpot Las Vegas	35
Bingo Jackpot New York	36
Power Tower Series	37
Power Tower Dragon	38
Power Tower Lion	39
Double Firestorm Series	40
Double Firestorm Buffalo	41
Double Firestorm Wolf	42
Pow Pow Panda Series	43
Pow Pow Panda Gong Fortune	44
Pow Pow Panda Gong Jewelry Extreme	45

## MUSO TRIPLE-32 HYBRID

---

MUSO TRIPLE-32 Hybrid (Cabinet Feature)	46
Fortune Frame Series	47
Fortune Frame Dragon Bounty	48
Fortune Frame Panda Carnival	49
Dancing Panda Supreme Series	50
Dancing Panda Supreme Festival	51
Dancing Panda Supreme Fortune	52
Tomb Treasure Series	53
Tomb Treasure Cleopatra Legend	54
Tomb Treasure Pharaoh Gold	55
Tomb Treasure Sphinx Gold	56
Lightning Arrow Series	57
Lightning Arrow Dragon Tiger Supremacy	58
Lightning Arrow Twin Kingdom	59
Qian Duo Duo Series	60
Qian Duo Duo Dragon	61
Qian Duo Duo Ox	62
Happy Lion Series	63
Happy Lion Chinese Beast	64
Happy Lion Fortune Beast	65
Happy Lion Prosperous God	66

Fortune Key Series	67
Fortune Key First Emperor	68
Fortune Key Jade Empress	69

## HYPERSPEED

---

HYPERSPEED (Cabinet Feature)	70
Gong Cash Series	71
Gong Cash Dragon	72
Gong Cash Lion	73
Fu Jin Shu Series	74
Fu Jin Shu Dragon	75
Fu Jin Shu Phoenix	76
Cai Yun Lai Series	77
Cai Yun Lai Dragon	78
Cai Yun Lai Lion	79
Cai Yun Lai Panda	80
Fu Ru Yi Series	81
Fu Ru Yi Phoenix	82
Fu Ru Yi Kirin	83
Firestorm Series	84
Firestorm Bull	85
Firestorm Lion	86
Gong Gong Lai Fu Series	87
Gong Gong Lai Fu Caishen Riches	88
Gong Gong Lai Fu Mighty Buddha	89

## SPEED

---

SPEED (Cabinet Feature)	90
Co Co Coin Series	91
Co Co Coin Egyptian Treasure	92
Co Co Coin Pirates Treasure	92
Dancing Panda Series	93
Dancing Panda Fortune	94
Dancing Panda Festival	94
Fu Lai Cai Lai Series	95
Fu Lai Cai Lai 5 Sea Legends	96
Fu Lai Cai Lai Triple Festival	96
Fu Lai Cai Lai Stack Wild Luxury	96
Fortune Drums Series	97
Fortune Drums Dragon Boat	98
Fortune Drums Zodiac Beast	98
Fortune Drums Bag of Wealth	99
Fortune Drums Chinese Luxury	99
Bomb Collector Series	100
Bomb Collector Gold Heist	101
Bomb Collector Treasure Heist	101
Coin Collector Series	102
Coin Collector 5 Guardians	103
Coin Collector Aussie 5	103
Jack's Series	104
Jack's Haunted Wins	105
Jack's Winning Spell	105

## MUSO LIMITED

---

MUSO LIMITED (Cabinet Feature)	106
Ji Ji Fu Series	107
Ji Ji Fu Raging Dragon	108
Ji Ji Fu Raging Phoenix	108

## iGaming

---

iGaming	109
---------	-----





# AG2

Aruze has demonstrated its unique strength for delivering the most innovative products to the global casino gaming industry.

We convert universally entertaining ideas into reality through ground-breaking technologies and creativeness.

Every product we produce contains the spirit of excellence, the excitement of something new and a sense of anticipation.

Our vision is to be a valued and respected company within the global entertainment market and to provide a sense of pride and happiness to all Aruze team members and their families.



## Elevate the Game







# MUSO™ SUMMIT

Being the only one of its kind;  
unlike anything else.

Discover the ultimate blend of advanced technology and sleek design with our groundbreaking new cabinet.

It boasts a breathtaking 49-inch Vertical 4K display and a stylish 27-inch topper, offering an unmatched visual experience with 180-degree side-view High-Definition MINI LEDs.

As the innovation pioneer in the industry, our cabinet features transmissive 3D molding integrated with LEDs around the button deck, enhancing gameplay and providing a fully immersive experience.

Elevating the audio with 3D Sound by SOEN™, which ensures a rich and dynamic soundscape. **Elevate the Game.**



New side LCD display



New Face



## DIMENSION

(Without Stand Base)

### Upright Height

(Tower Light Included)

2191 mm (86.26 in)

### Upright Height

(Tower Light Excluded)

2098.3 mm (82.61 in)

### Width

710 mm (27.95 in)

### Depth

681.3 mm (26.82 in)

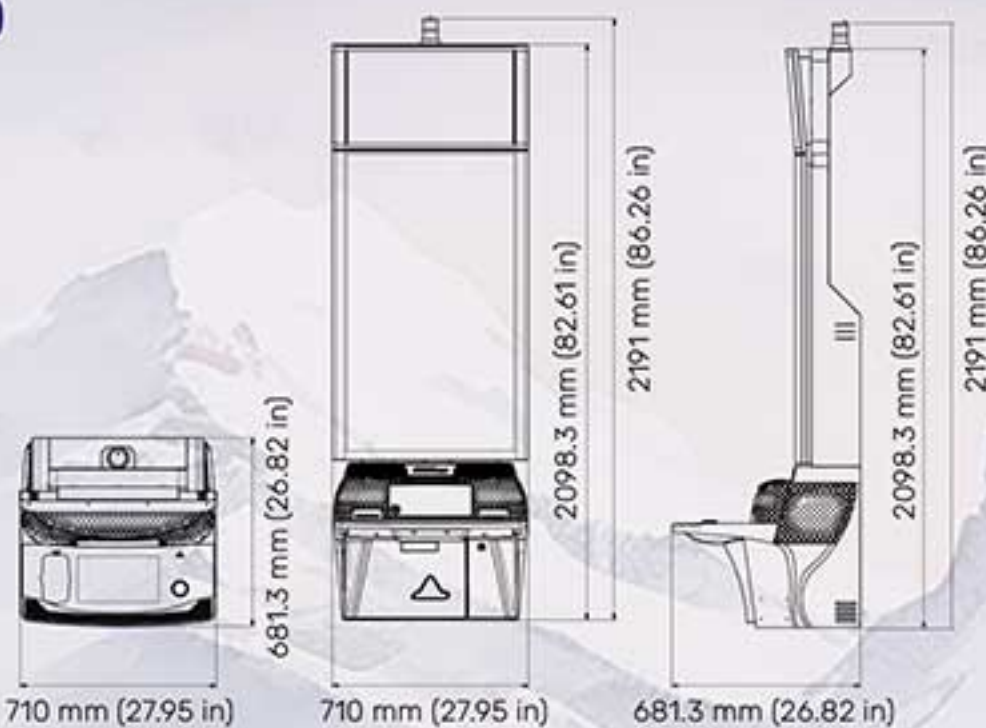

Please contact your Account Executive for more details.

sales@aruzeglobal.com

+1 702-781-8080

www.aruzeglobal.com

Follow us @AruzeGaming



Empire Technological Group Ltd dba  
Aruze Gaming Global





# MUSO™ SUMMIT

Being the only one of its kind;  
unlike anything else.

Discover the ultimate blend of advanced technology and sleek design with our groundbreaking new cabinet.

It boasts a breathtaking 49-inch Vertical 4K display and a stylish 27-inch topper, offering an unmatched visual experience with 180-degree side-view High-Definition MINI LEDs.

As the innovation pioneer in the industry, our cabinet features transmissive 3D molding integrated with LEDs around the button deck, enhancing gameplay and providing a fully immersive experience.

Elevating the audio with 3D Sound by SOEN™, which ensures a rich and dynamic soundscape. **Elevate the Game.**



New side LCD display



New Face



## DIMENSION (With Stand Base)

**Upright Height  
(Tower Light Included)**  
2622.8 mm (103.26 in)

**Upright Height  
(Tower Light Excluded)**  
2530.1 mm (99.61 in)

**Width**  
710 mm (27.95 in)

**Depth**  
686.4 mm (27.02 in)

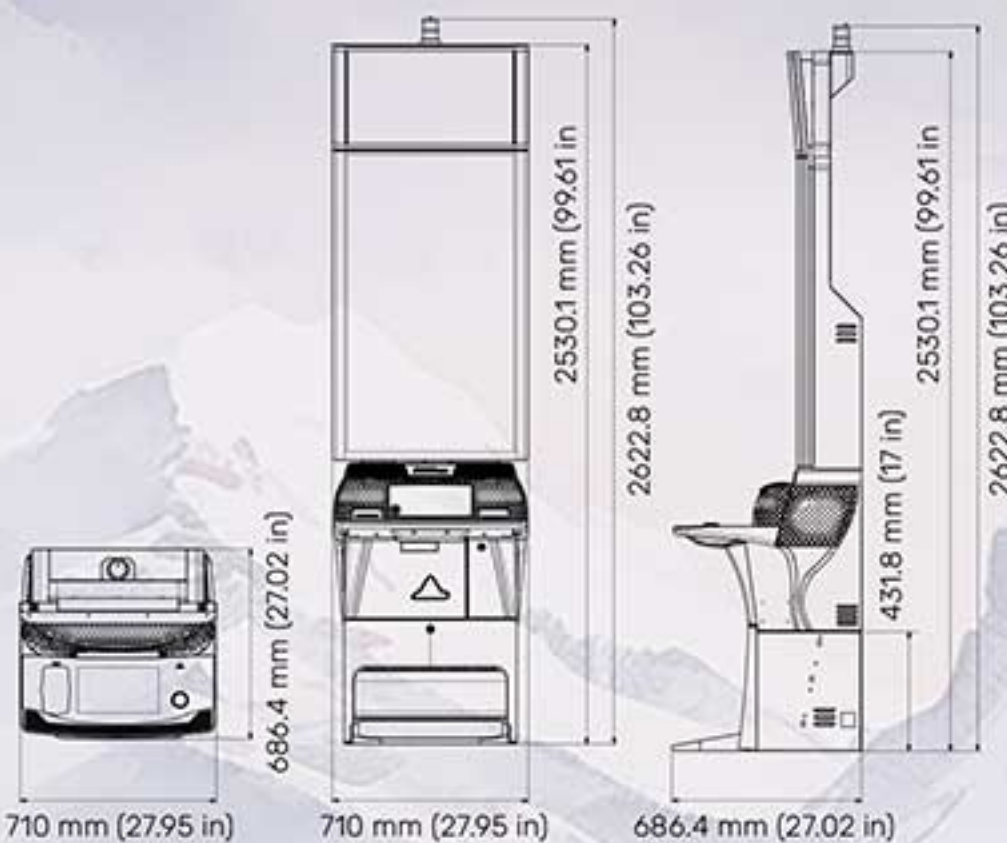

Please contact your Account Executive for more details.

sales@aruzeglobal.com

+1 702-781-8080

www.aruzeglobal.com

Follow us @AruzeGaming



Empire Technological Group Ltd dba  
Aruze Gaming Global



# PRODUCTS

At Aruze Gaming, we focus on creative innovations that produce the best gaming experience for players and supply premium quality products with outstanding service to our customers across the globe.



**MUSO™  
SUMMIT**

New MUSO SUMMIT Cabinet  
with POD Signage Package

Please contact your Account Executive for more details.

[sales@aruzeglobal.com](mailto:sales@aruzeglobal.com)

+1 702-781-8080

[www.aruzeglobal.com](http://www.aruzeglobal.com)

Follow us @AruzeGaming



Empire Technological Group Ltd dba  
Aruze Gaming Global



# HORRORIFIC!

IMMERSE YOURSELF  
IN THE ADRENALINE-FUELED REALM  
OF HORRORIFIC! MONSTER,  
WHERE EACH SPIN CHALLENGES  
YOUR BRAVERY!







**TYPE OF PRODUCT**

**LINK / SAP**

**REEL CONFIGURATION**

5-Reel 3-Row Video Slot

**PAYLINES**

50 Lines (Denomination 1, 2)  
25 Lines (Denomination 3, 4)  
5 Lines (Denomination 5, 6)

**DENOMINATIONS**

1	2	3	4	5	6
1c	2c	5c	10c	\$1	\$2
5c	10c	25c	50c	\$5	\$10
10c	20c	50c	\$1	\$10	\$20
50c	\$1	\$2.50	\$5	\$50	\$100
\$1	\$2	\$5	\$10	\$100	\$200

**BET CONFIGURATIONS**

1, 2, 3, 4, 5, 10

**MIN/MAX BET & Cost to Cover**

MIN BET	MAX BET	Cost to Cover	Denomination
50	500	50	Denomination 1, 2
25	250	25	Denomination 3, 4
5	50	5	Denomination 5, 6

(Depends on the above Bet Configurations)



**FREE GAMES FEATURE**









Any 3  appearing on any reel positions trigger the FREE GAMES FEATURE with 6 free games. Reels used during the FREE GAMES FEATURE do not contain **A, K, Q, J** and **10**.

During the FREE GAMES FEATURE, if 3 or more  appears, FREE GAMES FEATURE can be triggered again awarding 3 more free games. If triggered in the same game, the FREE GAMES FEATURE starts after the WOLFIE'S WILD HOLD FEATURE, FRANKIE'S FRAME HOLD FEATURE or MUMMY'S MONEY HOLD FEATURE ends.

If the WOLFIE'S WILD HOLD FEATURE, FRANKIE'S FRAME HOLD FEATURE or MUMMY'S MONEY HOLD FEATURE is triggered during the FREE GAMES FEATURE, any remaining free games resume after the WOLFIE'S WILD HOLD FEATURE, FRANKIE'S FRAME HOLD FEATURE or MUMMY'S MONEY HOLD FEATURE ends.

**FRANKIE'S FRAME HOLD FEATURE**





6 or more  triggers FRANKIE'S FRAME HOLD FEATURE. During FRANKIE'S FRAME HOLD FEATURE, the positions where  appears that triggers the FRANKIE'S FRAME HOLD FEATURE become . FRANKIE'S FRAME HOLD FEATURE consists of 6 free spins. Prizes displayed on  are won one time only for held  on the reels and will disappear once awarded for every FRANKIE'S FRAME HOLD FEATURE spins. Each newly appearing  is held in the position.  landing will award additional 1 FREE SPIN.

 prizes won at the end of FRANKIE'S FRAME HOLD FEATURE are added to any line wins from the game that triggered FRANKIE'S FRAME HOLD FEATURE. The FRANKIE'S FRAME HOLD FEATURE ends when all remaining spins are played.

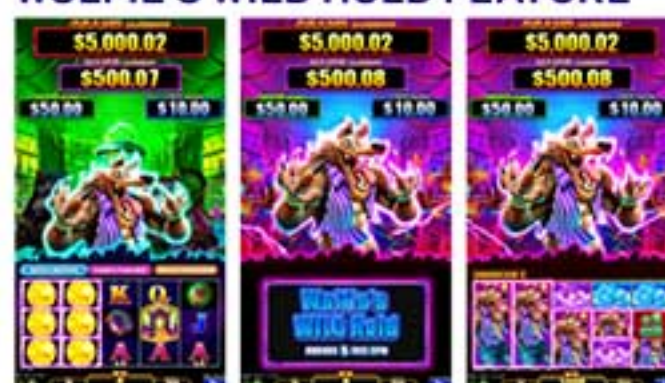



**WOLFIE'S WILD HOLD FEATURE**





6 or more  trigger WOLFIE'S WILD HOLD FEATURE. Prizes may appear on any of the  that triggers WOLFIE'S WILD HOLD FEATURE and is awarded before entering WOLFIE'S WILD HOLD FEATURE. WOLFIE'S WILD HOLD FEATURE consists of 6 free spins.  that triggered the WOLFIE'S WILD HOLD FEATURE are held in position and turns into . Each  that lands is held in position.  landing will award additional 1 FREE SPIN. The WOLFIE'S WILD HOLD FEATURE ends when free spins reach zero.

**MUMMY'S MONEY HOLD FEATURE**



6 or more  triggers MUMMY'S MONEY HOLD FEATURE. When MUMMY'S MONEY HOLD FEATURE is triggered, 3 spins are awarded initially. The  that triggered the MUMMY'S MONEY HOLD FEATURE are held in position and the rest of positions turn into individual spinning reels. If one or more additional  land, those symbols are also held and the number of free spins remaining is reset to 3. Prizes displayed on  are won one time only for held  on the reels at the end of MUMMY'S MONEY HOLD FEATURE only.

The MUMMY'S MONEY HOLD FEATURE ends when either no free spins remain, or all 15 positions are filled with . All prizes appearing are awarded at the end of the MUMMY'S MONEY HOLD FEATURE. GRAND JACKPOT is won if  appears in all 15 symbol positions.  prizes are added to the GRAND JACKPOT win. The MUMMY'S MONEY HOLD FEATURE ends when GRAND JACKPOT is won or when all remaining spins are played.

**JACKPOT SURPRISE**

There is a chance that the GRAND JACKPOT or MAJOR JACKPOT is randomly won in bought games except when WOLFIE'S WILD HOLD FEATURE, FRANKIE'S FRAME HOLD FEATURE or MUMMY'S MONEY HOLD FEATURE is triggered.





**TYPE OF PRODUCT**

[LINK](#) / [SAP](#)

**REEL CONFIGURATION**

5-Reel 3-Row Video Slot

**PAYLINES**

50 Lines (Denomination 1, 2)  
25 Lines (Denomination 3, 4)  
5 Lines (Denomination 5, 6)

**DENOMINATIONS**

1	2	3	4	5	6
1c	2c	5c	10c	\$1	\$2
5c	10c	25c	50c	\$5	\$10
10c	20c	50c	\$1	\$10	\$20
50c	\$1	\$2.50	\$5	\$50	\$100
\$1	\$2	\$5	\$10	\$100	\$200

**BET CONFIGURATIONS**

1, 2, 3, 4, 5, 10

**MIN/MAX BET & Cost to Cover**

MIN BET	MAX BET	Cost to Cover	Denomination
50	500	50	Denomination 1, 2
25	250	25	Denomination 3, 4
5	50	5	Denomination 5, 6

(Depends on the above Bet Configurations)

**FREE GAMES FEATURE**



Any 3  appearing on any reel positions trigger the FREE GAMES FEATURE with 6 free games.



During the FREE GAMES FEATURE,  /  /  substituting in a win becomes  /  / . During the FREE GAMES FEATURE, if 3 or more  appears, FREE GAMES FEATURE can be triggered again awarding 6 more free games. If triggered in the same game, the FREE GAMES FEATURE starts after the WOLFIE'S WILD HOLD FEATURE, FRANKIE'S FRAME HOLD FEATURE or MUMMY'S MONEY HOLD FEATURE ends.



If the WOLFIE'S WILD HOLD FEATURE, FRANKIE'S FRAME HOLD FEATURE or MUMMY'S MONEY HOLD FEATURE is triggered during the FREE GAMES FEATURE, any remaining free games resume after the WOLFIE'S WILD HOLD FEATURE, FRANKIE'S FRAME HOLD FEATURE or MUMMY'S MONEY HOLD FEATURE ends.



**FRANKIE'S FRAME HOLD FEATURE**



6 or more  triggers FRANKIE'S FRAME HOLD FEATURE.

During FRANKIE'S FRAME HOLD FEATURE, the positions where  appears that triggers the FRANKIE'S FRAME HOLD FEATURE become .

FRANKIE'S FRAME HOLD FEATURE consists of 6 free spins. Prizes displayed on  are won one time only for held  on the reels and will disappear once awarded for every FRANKIE'S FRAME HOLD FEATURE spins.

Each newly appearing  is held in the position.  landing will award additional 1 FREE SPIN.



 prizes won at the end of FRANKIE'S FRAME HOLD FEATURE are added to any line wins from the game that triggered FRANKIE'S FRAME HOLD FEATURE. The FRANKIE'S FRAME HOLD FEATURE ends when all remaining spins are played.

**WOLFIE'S WILD HOLD FEATURE**



6 or more  trigger WOLFIE'S WILD HOLD FEATURE.

Prizes may appear on any of the  that triggers WOLFIE'S WILD HOLD FEATURE and is awarded before entering WOLFIE'S WILD HOLD FEATURE.

WOLFIE'S WILD HOLD FEATURE consists of 6 free spins.  that triggered the WOLFIE'S WILD HOLD FEATURE are held in position and turns into .

Each  that lands is held in position.  landing will award additional 1 FREE SPIN. The WOLFIE'S WILD HOLD FEATURE ends when free spins reach zero.



**MUMMY'S MONEY HOLD FEATURE**





6 or more  triggers MUMMY'S MONEY HOLD FEATURE.

When MUMMY'S MONEY HOLD FEATURE is triggered, 3 spins are awarded initially.

The  that triggered the MUMMY'S MONEY HOLD FEATURE are held in position and the rest of positions turn into individual spinning reels.

If one or more additional  land, those symbols are also held and the number of free spins remaining is reset to 3. Prizes displayed on  are won one time only for held  on the reels at the end of MUMMY'S MONEY HOLD FEATURE only.

The MUMMY'S MONEY HOLD FEATURE ends when either no free spins remain, or all 15 positions are filled with .

All prizes appearing are awarded at the end of the MUMMY'S MONEY HOLD FEATURE. GRAND JACKPOT is won if  appears in all 15 symbol positions.  prizes are added to the GRAND JACKPOT win. The MUMMY'S MONEY HOLD FEATURE ends when GRAND JACKPOT is won or when all remaining spins are played.

**JACKPOT SURPRISE**

There is a chance that the GRAND JACKPOT or MAJOR JACKPOT is randomly won in bought games except when WOLFIE'S WILD HOLD FEATURE, FRANKIE'S FRAME HOLD FEATURE or MUMMY'S MONEY HOLD FEATURE is triggered.





**TYPE OF PRODUCT**

[LINK](#) / [SAP](#)

**REEL CONFIGURATION**

5-Reel 3-Row Video Slot

**PAYLINES**

50 Lines (Denomination 1, 2)  
25 Lines (Denomination 3, 4)  
5 Lines (Denomination 5, 6)

**DENOMINATIONS**

1	2	3	4	5	6
1c	2c	5c	10c	\$1	\$2
5c	10c	25c	50c	\$5	\$10
10c	20c	50c	\$1	\$10	\$20
50c	\$1	\$2.50	\$5	\$50	\$100
\$1	\$2	\$5	\$10	\$100	\$200

**BET CONFIGURATIONS**

1, 2, 3, 4, 5, 10



**MIN/MAX BET & Cost to Cover**

MIN BET	MAX BET	Cost to Cover	Denomination
50	500	50	Denomination 1, 2
25	250	25	Denomination 3, 4
5	50	5	Denomination 5, 6

(Depends on the above Bet Configurations)







**FREE GAMES FEATURE**



Any 3  appearing on any reel positions trigger the FREE GAMES FEATURE with 6 free games. Reels used during the FREE GAMES FEATURE do not contain **A, K, Q, J** and **10**. During the FREE GAMES FEATURE, if 3 or more  appears, FREE GAMES FEATURE can be triggered again awarding 3 more free games. If the DRACASH'S GET ALL FEATURE, GHOST'S MATCH3 AWARD FEATURE or SKULL'S CASH HOLD FEATURE is triggered during the FREE GAMES FEATURE, any remaining free games resume after the DRACASH'S GET ALL FEATURE, GHOST'S MATCH3 AWARD FEATURE or SKULL'S CASH HOLD FEATURE ends. If triggered in the same game, the FREE GAMES FEATURE starts after the DRACASH'S GET ALL FEATURE, GHOST'S MATCH3 AWARD FEATURE or SKULL'S CASH HOLD FEATURE ends.

**DRACASH'S GET ALL FEATURE**



6 or more  triggers DRACASH'S GET ALL FEATURE. When DRACASH'S GET ALL FEATURE is triggered, 3 spins are awarded initially. The  that triggered the DRACASH'S GET ALL FEATURE are held in position and the rest of positions turn into individual spinning reels. If one or more additional  land, those symbols are also held and the number of free spins remaining is reset to 3. When one or more BONUS symbols appear at the same time, the contents of the BONUS symbols that appear are drawn, and then the payout for all  that appear on the screen is awarded for the number of  that appeared. Paytable prizes are not awarded during the DRACASH'S GET ALL FEATURE. GRAND JACKPOT is won if  appears in all 15 symbol positions.  prizes are added to the GRAND JACKPOT win. The DRACASH'S GET ALL FEATURE ends when GRAND JACKPOT is won or when all remaining spins are played.

**GHOST'S MATCH3 AWARD FEATURE**



6 or more  triggers GHOST'S MATCH3 AWARD FEATURE. When GHOST'S MATCH3 AWARD FEATURE is triggered, the number of spin awarded is the total of the number displayed on  that triggers GHOST'S MATCH3 AWARD FEATURE. The prizes shown at the top of each reel may change for each spin, 3  appearing on the reel awards the value at the top of that reel. Once the prize on the top of the reel is awarded, that prize will be fixed for the duration of the FEATURE.  prizes won at the end of GHOST'S MATCH3 AWARD FEATURE are added to any line wins from the game that triggered GHOST'S MATCH3 AWARD FEATURE.

**SKULL'S CASH HOLD FEATURE**



6 or more  triggers SKULL'S CASH HOLD FEATURE. When SKULL'S CASH HOLD FEATURE is triggered, 3 spins are awarded initially. The  that triggered the SKULL'S CASH HOLD FEATURE are held in position and the rest of positions turn into individual spinning reels. If one or more additional  land, those symbols are also held and the number of free spins remaining is reset to 3. The SKULL'S CASH HOLD FEATURE ends when either no free spins remain, or all 15 positions are filled with . All prizes appearing are awarded at the end of the SKULL'S CASH HOLD FEATURE. GRAND JACKPOT is won if  appears in all 15 symbol positions.  prizes are added to the GRAND JACKPOT win. The SKULL'S CASH HOLD FEATURE ends when GRAND JACKPOT is won or when all remaining spins are played.

**JACKPOT SURPRISE**

There is a chance that the GRAND JACKPOT or MAJOR JACKPOT is randomly won in bought games except when DRACASH'S GET ALL FEATURE, GHOST'S MATCH3 AWARD FEATURE or SKULL'S CASH HOLD FEATURE is triggered.





**TYPE OF PRODUCT**

[LINK](#) / [SAP](#)

**REEL CONFIGURATION**

5-Reel 3-Row Video Slot

**PAYLINES**

50 Lines (Denomination 1, 2)  
25 Lines (Denomination 3, 4)  
5 Lines (Denomination 5, 6)

**DENOMINATIONS**

1	2	3	4	5	6
1c	2c	5c	10c	\$1	\$2
5c	10c	25c	50c	\$5	\$10
10c	20c	50c	\$1	\$10	\$20
50c	\$1	\$2.50	\$5	\$50	\$100
\$1	\$2	\$5	\$10	\$100	\$200

**BET CONFIGURATIONS**

1, 2, 3, 4, 5, 10











**MIN/MAX BET & Cost to Cover**

MIN BET	MAX BET	Cost to Cover	Denomination
50	500	50	Denomination 1, 2
25	250	25	Denomination 3, 4
5	50	5	Denomination 5, 6

(Depends on the above Bet Configurations)

**FREE GAMES FEATURE**









Any 3  appearing on any reel positions trigger the FREE GAMES FEATURE with 6 free games. During the FREE GAMES FEATURE,  /  /  substituting in a win becomes  /  / . The sum of multipliers from every  /  /  that substitutes in a win multiplies the pay for that win. During the FREE GAMES FEATURE, if 3 or more  appears, FREE GAMES FEATURE can be triggered again awarding 6 more free games. If the DRACASH'S GET ALL FEATURE, GHOST'S MATCH3 AWARD FEATURE or SKULL'S CASH HOLD FEATURE is triggered during the FREE GAMES FEATURE, any remaining free games resume after the DRACASH'S GET ALL FEATURE, GHOST'S MATCH3 AWARD FEATURE or SKULL'S CASH HOLD FEATURE ends.

If triggered in the same game, the FREE GAMES FEATURE starts after the DRACASH'S GET ALL FEATURE, GHOST'S MATCH3 AWARD FEATURE or SKULL'S CASH HOLD FEATURE ends.

**DRACASH'S GET ALL FEATURE**







6 or more  triggers DRACASH'S GET ALL FEATURE. When DRACASH'S GET ALL FEATURE is triggered, 3 spins are awarded initially. The  that triggered the DRACASH'S GET ALL FEATURE are held in position and the rest of positions turn into individual spinning reels. If one or more additional  land, those symbols are also held and the number of free spins remaining is reset to 3. When one or more BONUS symbols appear at the same time, the contents of the BONUS symbols that appear are drawn, and then the payout for all  that appear on the screen is awarded for the number of  that appeared.

Paytable prizes are not awarded during the DRACASH'S GET ALL FEATURE. GRAND JACKPOT is won if  appears in all 15 symbol positions.  prizes are added to the GRAND JACKPOT win. The DRACASH'S GET ALL FEATURE ends when GRAND JACKPOT is won or when all remaining spins are played.

**GHOST'S MATCH3 AWARD FEATURE**









6 or more  triggers GHOST'S MATCH3 AWARD FEATURE. When GHOST'S MATCH3 AWARD FEATURE is triggered, the number of spin awarded is the total of the number displayed on  that triggers GHOST'S MATCH3 AWARD FEATURE. The prizes shown at the top of each reel may change for each spin. 3  appearing on the reel awards the value at the top of that reel. Once the prize on the top of the reel is awarded, that prize will be fixed for the duration of the FEATURE.  prizes won at the end of GHOST'S MATCH3 AWARD FEATURE are added to any line wins from the game that triggered GHOST'S MATCH3 AWARD FEATURE.

The GHOST'S MATCH3 AWARD FEATURE ends when GRAND JACKPOT is won or when all remaining spins are played.

**SKULL'S CASH HOLD FEATURE**



6 or more  triggers SKULL'S CASH HOLD FEATURE. When SKULL'S CASH HOLD FEATURE is triggered, 3 spins are awarded initially. The  that triggered the SKULL'S CASH HOLD FEATURE are held in position and the rest of positions turn into individual spinning reels. If one or more additional  land, those symbols are also held and the number of free spins remaining is reset to 3. The SKULL'S CASH HOLD FEATURE ends when either no free spins remain, or all 15 positions are filled with . All prizes appearing are awarded at the end of the SKULL'S CASH HOLD FEATURE.

GRAND JACKPOT is won if  appears in all 15 symbol positions.  prizes are added to the GRAND JACKPOT win.

The SKULL'S CASH HOLD FEATURE ends when GRAND JACKPOT is won or when all remaining spins are played.

**JACKPOT SURPRISE**

There is a chance that the GRAND JACKPOT or MAJOR JACKPOT is randomly won in bought games except when DRACASH'S GET ALL FEATURE, GHOST'S MATCH3 AWARD FEATURE or SKULL'S CASH HOLD FEATURE is triggered.



# CASH MASTER BLASTER™

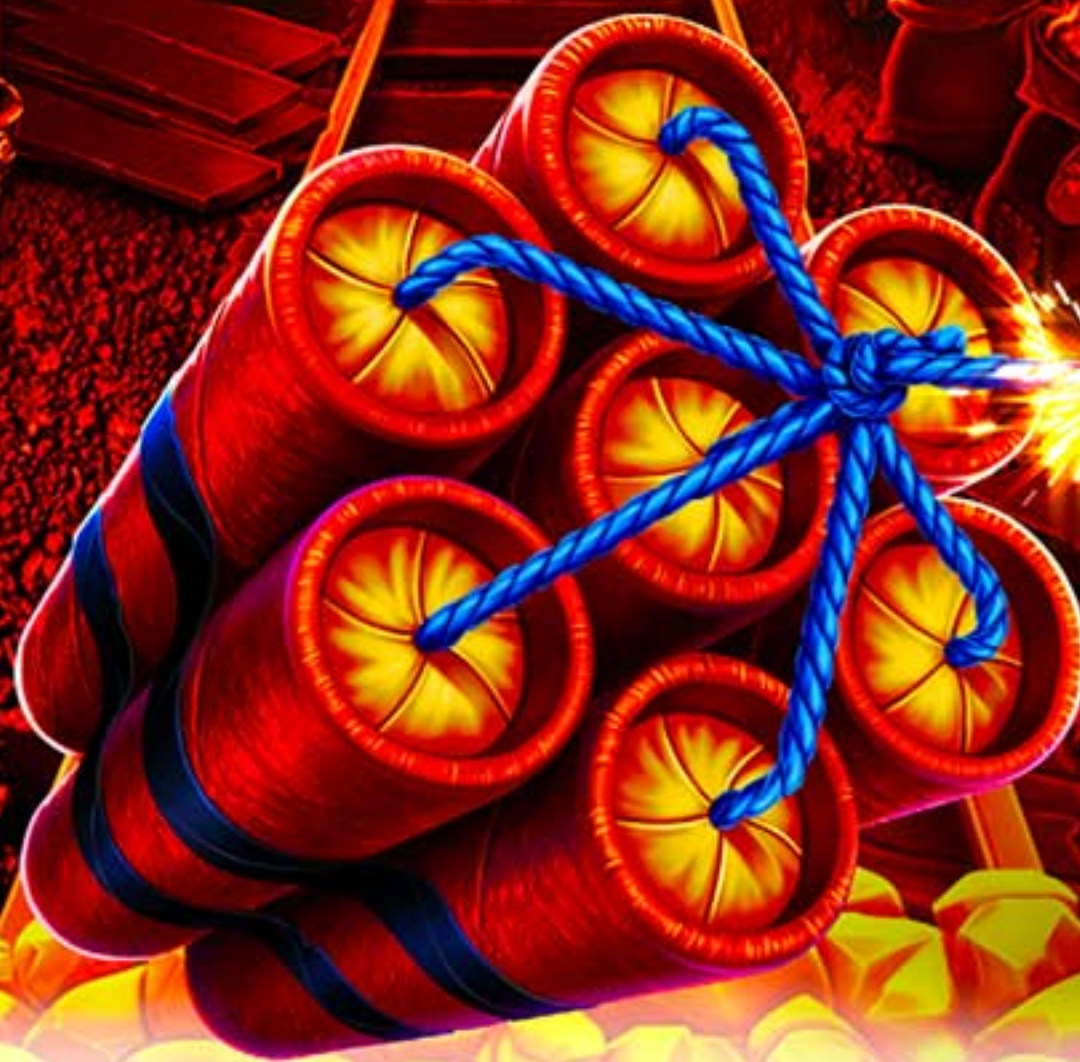



Blast your way to  
fortune with dynamite  
surprises around  
every corner!





**DYNAMITE SPIN FEATURE**





3 scattered  appearing on reels 2, 3 and 4 trigger the DYNAMITE SPIN FEATURE. There is a chance that the DYNAMITE SPIN FEATURE may be randomly triggered when any 1 or more  or  appears in bought games only.

When the DYNAMITE SPIN FEATURE is triggered, 3 free spins are awarded.

Each newly appearing  displaying  in a free spin awards 1 additional free spin.



DYNAMITE SPIN FEATURE ends after all awarded free spins have been played.

During bought games and DYNAMITE SPIN FEATURE, any appearing  explodes to become  awarding 1 of the following:

PRIZE AMOUNT: 10 to 2000 credits multiplied by bet multiplier as displayed.

BONUS: MINOR BONUS or MINI BONUS



 appear during DYNAMITE SPIN FEATURE only.

During bought games and DYNAMITE SPIN FEATURE, any appearing  explodes to become  awarding 1 of the following:

PRIZE AMOUNT: 100 to 2000 credits multiplied by bet multiplier as displayed.

BONUS: MINOR BONUS or MINI BONUS

 appear during DYNAMITE SPIN FEATURE only.

During bought games and DYNAMITE SPIN FEATURE, any appearing  explodes to become  awarding 1 of the following:



PRIZE AMOUNT: 500 to 2000 credits multiplied by bet multiplier as displayed.

BONUS: MINOR BONUS or MINI BONUS

JACKPOT: GRAND JACKPOT or MAJOR JACKPOT

**MYSTERY**



There is a chance that the DYNAMITE SPIN FEATURE may be randomly triggered when any 1 or more  or  appears in bought games only.

**TYPE OF PRODUCT**

[LINK](#) / [SAP](#)

**REEL CONFIGURATION**

5-Reel 3-Row Video Slot

**PAYLINES**

20, 30 Lines

**DENOMINATIONS**

1	2	3	4
1c	2c	5c	10c
2c	5c	10c	20c
5c	10c	20c	50c
10c	20c	50c	\$1
20c	50c	\$1	\$2
50c	\$1	\$2	\$5
\$1	\$2	\$5	\$10

**BET CONFIGURATIONS**

1, 2, 3, 4, 5, 6, 7, 8, 9, 10

**MIN/MAX BET & Cost to Cover**

MIN BET	MAX BET	Cost to Cover
75	750	75
50	500	50



(Depends on the above Bet Configurations)





**DYNAMITE SPIN FEATURE**





3 scattered  appearing on reels 2, 3 and 4 trigger the DYNAMITE SPIN FEATURE. There is a chance that the DYNAMITE SPIN FEATURE may be randomly triggered when any 1 or more  or  appears in bought games only.

When the DYNAMITE SPIN FEATURE is triggered, 3 free spins are awarded.

Each newly appearing  displaying  in a free spin awards 1 additional free spin.



DYNAMITE SPIN FEATURE ends after all awarded free spins have been played.

During bought games and DYNAMITE SPIN FEATURE, any appearing  explodes to become  awarding 1 of the following:

PRIZE AMOUNT: 10 to 2000 credits multiplied by bet multiplier as displayed.

BONUS: MINOR BONUS or MINI BONUS



 appear during DYNAMITE SPIN FEATURE only.

During bought games and DYNAMITE SPIN FEATURE, any appearing  explodes to become  awarding 1 of the following:

PRIZE AMOUNT: 100 to 2000 credits multiplied by bet multiplier as displayed.

BONUS: MINOR BONUS or MINI BONUS

 appear during DYNAMITE SPIN FEATURE only.

During bought games and DYNAMITE SPIN FEATURE, any appearing  explodes to become  awarding 1 of the following:



PRIZE AMOUNT: 500 to 2000 credits multiplied by bet multiplier as displayed.

BONUS: MINOR BONUS or MINI BONUS

JACKPOT: GRAND JACKPOT or MAJOR JACKPOT

**MYSTERY**



There is a chance that the DYNAMITE SPIN FEATURE may be randomly triggered when any 1 or more  or  appears in bought games only.

**TYPE OF PRODUCT**

[LINK](#) / [SAP](#)

**REEL CONFIGURATION**

5-Reel 3-Row Video Slot

**PAYLINES**

20, 30 Lines

**DENOMINATIONS**

1	2	3	4
1c	2c	5c	10c
2c	5c	10c	20c
5c	10c	20c	50c
10c	20c	50c	\$1
20c	50c	\$1	\$2
50c	\$1	\$2	\$5
\$1	\$2	\$5	\$10

**BET CONFIGURATIONS**

1, 2, 3, 4, 5, 6, 7, 8, 9, 10

**MIN/MAX BET & Cost to Cover**

MIN BET	MAX BET	Cost to Cover
75	750	75
50	500	50

(Depends on the above Bet Configurations)



# Mr. Caliente's DANCE PARTY™

# Mr. Dig-me A WINNER™



**Buy a Feature  
for instant action  
and excitement!**





**TYPE OF PRODUCT**

[LINK](#) / [SAP](#)

**REEL CONFIGURATION**

5-Reel 3-Row Video Slot

**PAYLINES**

50 Lines

**DENOMINATIONS**

1	2	3
1c	2c	5c
\$1	\$2	\$5

**BET CONFIGURATIONS**

1, 2, 3, 4, 5, 6, 7, 8, 9, 10











**MIN/MAX BET & Cost to Cover**

MIN BET	MAX BET	Cost to Cover
75	750	75

(Instant Trigger: 4500 up to 45000 Bet)  
(Depends on the above Bet Configurations)











**EXTRA FEATURE**

There is a chance that EXTRA FEATURE is triggered when 1 or more  appears. EXTRA FEATURE consist of 4 free spins. During the EXTRA FEATURE, each symbol position becomes an individual spinning bonus reel. Any new appearing  are held in position on the reels for the duration of the EXTRA FEATURE. Each new  appearing in a free spin resets the number of remaining free spins to 4 and is held in position for the duration of the EXTRA FEATURE. Any appearing  or  may trigger the EXTRA BOOST FEATURE, EXTRA JACKPOT FEATURE, or MEGA FEATURE. When  /  appear, the number of remaining free spins will also reset for the EXTRA FEATURE.  and  can only be triggered once and it will not held for the duration of the EXTRA FEATURE. EXTRA FEATURE ends after all awarded free spins have been played or if  appears in all 15 symbol positions.











**BOOST FEATURE**

There is a chance that BOOST FEATURE is triggered when 1 or more  appears. BOOST FEATURE consist of 3 free spins. During the BOOST FEATURE, each symbol position becomes an individual spinning bonus reel. Any new appearing  are held in position on the reels for the duration of the BOOST FEATURE. Each new  appearing in a free spin resets the number of remaining free spins to 3 and is held in position for the duration of the BOOST FEATURE. Any appearing  or  may trigger the EXTRA BOOST FEATURE, EXTRA JACKPOT FEATURE, or MEGA FEATURE. When  /  appear, the number of remaining free spins will also reset for the BOOST FEATURE. Each prize displayed on  will be double. BOOST FEATURE ends after all awarded free spins have been played or if  appears in all 15 symbol positions.











**JACKPOT FEATURE**

There is a chance that JACKPOT FEATURE is triggered when 1 or more  appears. JACKPOT FEATURE consists of 3 free spins. Any new appearing  are held in position on the reels for the duration of the JACKPOT FEATURE. During the JACKPOT FEATURE, reels 2, 3 and 4 is merge to form one large center reel and each symbol position becomes an individual spinning bonus reel. Each new  appearing in a free spin resets the number of remaining free spins to 3 and is held in position for the duration of the JACKPOT FEATURE. Any appearing  or  may trigger the EXTRA BOOST FEATURE, EXTRA JACKPOT FEATURE, or MEGA FEATURE. When  /  appear, the number of remaining free spins will also reset for the JACKPOT FEATURE. JACKPOT FEATURE ends after all awarded free spins have been played or if  appears in all 7 symbol positions.















**MEGA FEATURE**

There is a chance that MEGA FEATURE is triggered when 1 or more , 1 or more  and 1 or more  appear in the same spin. Any new appearing , , or  are held in position on the reels for the duration of the MEGA FEATURE. During MEGA FEATURE, all features will be unlocked and play respectively. MEGA FEATURE ends after all awarded free spins in every feature have been played or if  and  appears in all 15 symbol positions and if  appears in all 7 symbol positions.



**INSTANT TRIGGER**

 can only be played at 4500 credits multiplied by bet multiplier as displayed. 1 of the following features EXTRA FEATURE, BOOST FEATURE, JACKPOT FEATURE, EXTRA BOOST FEATURE, EXTRA JACKPOT FEATURE, BOOST JACKPOT FEATURE and MEGA FEATURE can be randomly awarded by pressing the  button. Choose your bet multiplier. Selecting  will take you to a confirmation screen to buy the feature. Selecting  on the confirmation screen will exit and back to the previous screen. Selecting  will exit the  and confirmation screen. Selecting  on the confirmation screen will play the .  is accessible during bought game only. Paytable prizes are not awarded during . Bet multiplier during the  are the same as the game that triggered the .





**TYPE OF PRODUCT**

[LINK](#) / [SAP](#)

**REEL CONFIGURATION**

5-Reel 3-Row Video Slot

**PAYLINES**

50 Lines

**DENOMINATIONS**

1	2	3
1c	2c	5c
\$1	\$2	\$5

**BET CONFIGURATIONS**

1, 2, 3, 4, 5, 6, 7, 8, 9, 10











**MIN/MAX BET & Cost to Cover**

MIN BET	MAX BET	Cost to Cover
75	750	75

(Instant Trigger: 4500 up to 45000 Bet)  
(Depends on the above Bet Configurations)











**EXTRA FEATURE**

There is a chance that EXTRA FEATURE is triggered when 1 or more  appears. EXTRA FEATURE consist of 4 free spins. During the EXTRA FEATURE, each symbol position becomes an individual spinning bonus reel. Any new appearing  are held in position on the reels for the duration of the EXTRA FEATURE. Each new  appearing in a free spin resets the number of remaining free spins to 4 and is held in position for the duration of the EXTRA FEATURE. Any appearing  or  may trigger the EXTRA BOOST FEATURE, EXTRA JACKPOT FEATURE, or MEGA FEATURE. When  /  appear, the number of remaining free spins will also reset for the EXTRA FEATURE.  and  can only be triggered once and it will not held for the duration of the EXTRA FEATURE. EXTRA FEATURE ends after all awarded free spins have been played or if  appears in all 15 symbol positions.











**BOOST FEATURE**

There is a chance that BOOST FEATURE is triggered when 1 or more  appears. BOOST FEATURE consist of 3 free spins. During the BOOST FEATURE, each symbol position becomes an individual spinning bonus reel. Any new appearing  are held in position on the reels for the duration of the BOOST FEATURE. Each new  appearing in a free spin resets the number of remaining free spins to 3 and is held in position for the duration of the BOOST FEATURE. Any appearing  or  may trigger the EXTRA BOOST FEATURE, EXTRA JACKPOT FEATURE, or MEGA FEATURE. When  /  appear, the number of remaining free spins will also reset for the BOOST FEATURE. Each prize displayed on  will be double. BOOST FEATURE ends after all awarded free spins have been played or if  appears in all 15 symbol positions.











**JACKPOT FEATURE**

There is a chance that JACKPOT FEATURE is triggered when 1 or more  appears. JACKPOT FEATURE consists of 3 free spins. Any new appearing  are held in position on the reels for the duration of the JACKPOT FEATURE. During the JACKPOT FEATURE, reels 2, 3 and 4 is merge to form one large center reel and each symbol position becomes an individual spinning bonus reel. Each new  appearing in a free spin resets the number of remaining free spins to 3 and is held in position for the duration of the JACKPOT FEATURE. Any appearing  or  may trigger the EXTRA BOOST FEATURE, EXTRA JACKPOT FEATURE, or MEGA FEATURE. When  /  appear, the number of remaining free spins will also reset for the JACKPOT FEATURE. JACKPOT FEATURE ends after all awarded free spins have been played or if  appears in all 7 symbol positions.













**MEGA FEATURE**

There is a chance that MEGA FEATURE is triggered when 1 or more , 1 or more  and 1 or more  appear in the same spin. Any new appearing , , or  are held in position on the reels for the duration of the MEGA FEATURE. During MEGA FEATURE, all features will be unlocked and play respectively. MEGA FEATURE ends after all awarded free spins in every feature have been played or if  and  appears in all 15 symbol positions and if  appears in all 7 symbol positions.



**INSTANT TRIGGER**

 can only be played at 4500 credits multiplied by bet multiplier as displayed. 1 of the following features EXTRA FEATURE, BOOST FEATURE, JACKPOT FEATURE, EXTRA BOOST FEATURE, EXTRA JACKPOT FEATURE, BOOST JACKPOT FEATURE and MEGA FEATURE can be randomly awarded by pressing the  button. Choose your bet multiplier. Selecting  will take you to a confirmation screen to buy the feature. Selecting  on the confirmation screen will exit and back to the previous screen. Selecting  will exit the  and confirmation screen. Selecting  on the confirmation screen will play the .  is accessible during bought game only. Paytable prizes are not awarded during . Bet multiplier during the  are the same as the game that triggered the .



# MYSTERY OF FANTASTIC DRAGONS™



The mighty  
dragon delivers  
powerful wins!





**TYPE OF PRODUCT**

LINK / SAP

**REEL CONFIGURATION**

5-Reel 6-Row Video Slot

**PAYLINES**

50 Lines (Bet Level 1)  
100 Lines (Bet Level 2)  
100 Lines (Bet Level 3)

**DENOMINATIONS**

1	2	3	4
1c	2c	5c	10c
2c	5c	10c	20c
5c	10c	20c	50c
10c	20c	50c	\$1
20c	50c	\$1	\$2
50c	\$1	\$2	\$5
\$1	\$2	\$5	\$10

**BET CONFIGURATIONS**

1, 2, 3, 4, 5  
1, 2, 3, 5, 10  
1, 2, 5, 10, 15  
1, 2, 5, 10, 20

**MIN/MAX BET & Cost to Cover**







MIN BET	MAX BET	Cost to Cover	BET LEVEL
50	1000	50	Bet Level 1
100	2000	100	Bet Level 2
150	3000	150	Bet Level 3







(Depends on the above Bet Configurations)



**EXTRA ORBS**



PLAY 50 LINES	LOWER REELS WINDOW 50 LINES
PLAY 100 LINES	LOWER REELS WINDOW 50 LINES UPPER REELS WINDOW 50 LINES
EXTRA ORBS ACTIVATED PLAY 100 LINES	EXTRA ORBS ACTIVATED IN BOUGHT GAMES & FREE GAMES LOWER REELS WINDOW 50 LINES UPPER REELS WINDOW 50 LINES

When playing the "EXTRA ORBS" play option, extra       may appear randomly in any symbol position during bought games and free games.

Any symbol appearing in the same position as the extra       is valid and displayed alternately if part of a win.

 become  after awarding EXTRA OBS.

**FREE GAMES FEATURE**



Any 3 or more  trigger the FREE GAMES FEATURE.

FREE GAMES FEATURE consists of 6 free games only.

If the FREE GAMES FEATURE and the ORB SPIN BONUS FEATURE are triggered in the same game, the FREE GAMES FEATURE starts after the ORB SPIN BONUS FEATURE ends.

If ORB SPIN BONUS FEATURE is triggered during the FREE GAMES FEATURE, remaining free games resume after the ORB SPIN BONUS FEATURE ends.

Bet multiplier, play option and lines played during the FREE GAMES FEATURE are the same as the game that triggered the FREE GAMES FEATURE.



















**ORB SPIN BONUS FEATURE**



Any combination of 6 or more       in the lower reel window in a bought game or free game triggers the ORB SPIN BONUS FEATURE with 3 free spins played in the lower reel window only. Any combination of 6 or more   in the upper reel window in a bought game or free game triggers the ORB SPIN BONUS FEATURE with 3 free spins played in the upper reel window only. The triggering       and any newly appearing       descend to the lowest open symbol position on the reel in the reel window in which they appeared and are held until the end of the ORB SPIN BONUS FEATURE. Each newly appearing       in a free spin resets the number of remaining free spins to 3. In the reel window(s) that free spins are played, all symbol positions become individual spinning bonus reels.

**PRIZE REEL/SUPER PRIZE REEL**



If the ORB SPIN BONUS FEATURE is played in a single reel window only, any combination of 15       trigger the PRIZE REEL FEATURE. If the ORB SPIN BONUS FEATURE is played in both the lower and upper reel windows together, any combination of 15       in the lower reel window triggers the PRIZE REEL FEATURE and any combination of 15       in the upper reel window triggers the SUPER PRIZE REEL. When the PRIZE REEL/SUPER PRIZE REEL stops, 1 winning segment on the reel is indicated by the pointers. The contents of the PRIZE REEL and SUPER PRIZE REEL are credit prize, multipliers, bonus and jackpots.

PRIZE REEL	SUPER PRIZE REEL
Credit Prizes: 100, 250, 500, 1000, 1500 and 2500 credits multiplied by bet multiplier as displayed.	Credit Prizes: 500, 1000, 1500, 2500, 3750 and 5000 credits multiplied by bet multiplier as displayed.
Multipliers: x2 and x3	Multipliers: x2, x3, x4, and x5
 BONUS and  BONUS	
 JACKPOT and  JACKPOT	





**TYPE OF PRODUCT**

LINK / SAP

**REEL CONFIGURATION**

5-Reel 6-Row Video Slot

**PAYLINES**

50 Lines (Bet Level 1)  
100 Lines (Bet Level 2)  
100 Lines (Bet Level 3)

**DENOMINATIONS**

1	2	3	4
1c	2c	5c	10c
2c	5c	10c	20c
5c	10c	20c	50c
10c	20c	50c	\$1
20c	50c	\$1	\$2
50c	\$1	\$2	\$5
\$1	\$2	\$5	\$10

**BET CONFIGURATIONS**

1, 2, 3, 4, 5  
1, 2, 3, 5, 10  
1, 2, 5, 10, 15  
1, 2, 5, 10, 20

**MIN/MAX BET & Cost to Cover**







MIN BET	MAX BET	Cost to Cover	BET LEVEL
50	1000	50	Bet Level 1
100	2000	100	Bet Level 2
150	3000	150	Bet Level 3







(Depends on the above Bet Configurations)



**EXTRA ORBS**



PLAY 50 LINES	LOWER REELS WINDOW 50 LINES
PLAY 100 LINES	LOWER REELS WINDOW 50 LINES UPPER REELS WINDOW 50 LINES
EXTRA ORBS ACTIVATED PLAY 100 LINES	EXTRA ORBS ACTIVATED IN BOUGHT GAMES & FREE GAMES LOWER REELS WINDOW 50 LINES UPPER REELS WINDOW 50 LINES

When playing the "EXTRA ORBS" play option, extra       may appear randomly in any symbol position during bought games and free games.

Any symbol appearing in the same position as the extra       is valid and displayed alternately if part of a win.

 become  after awarding EXTRA OBS.

**FREE GAMES FEATURE**



Any 3 or more  trigger the FREE GAMES FEATURE. FREE GAMES FEATURE consists of 6 free games only. In the spin that  appears during FREE GAME only, any symbol position on a reel, all symbol positions on that reel become .

If the FREE GAMES FEATURE and the ORB SPIN BONUS FEATURE are triggered in the same game, the FREE GAMES FEATURE starts after the ORB SPIN BONUS FEATURE ends.

If ORB SPIN BONUS FEATURE is triggered during the FREE GAMES FEATURE, remaining free games resume after the ORB SPIN BONUS FEATURE ends.

Bet multiplier, play option and lines played during the FREE GAMES FEATURE are the same as the game that triggered the FREE GAMES FEATURE.









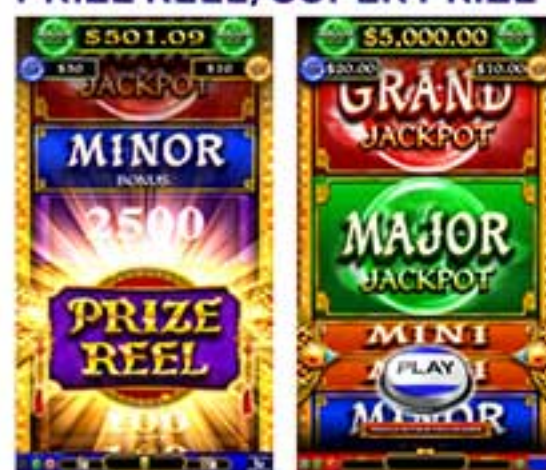









**ORB SPIN BONUS FEATURE**



Any combination of 6 or more       in the lower reel window in a bought game or free game triggers the ORB SPIN BONUS FEATURE with 3 free spins played in the lower reel window only. Any combination of 6 or more       in the upper reel window in a bought game or free game triggers the ORB SPIN BONUS FEATURE with 3 free spins played in the upper reel window only. The triggering       and any newly appearing       descend to the lowest open symbol position on the reel in the reel window in which they appeared and are held until the end of the ORB SPIN BONUS FEATURE. Each newly appearing       in a free spin resets the number of remaining free spins to 3. In the reel window(s) that free spins are played, all symbol positions become individual spinning bonus reels.

**PRIZE REEL/SUPER PRIZE REEL**



If the ORB SPIN BONUS FEATURE is played in a single reel window only, any combination of 15       trigger the PRIZE REEL FEATURE. If the ORB SPIN BONUS FEATURE is played in both the lower and upper reel windows together, any combination of 15       in the lower reel window triggers the PRIZE REEL FEATURE and any combination of 15       in the upper reel window triggers the SUPER PRIZE REEL. When the PRIZE REEL/SUPER PRIZE REEL stops, 1 winning segment on the reel is indicated by the pointers. The contents of the PRIZE REEL and SUPER PRIZE REEL are credit prize, multipliers, bonus and jackpots.

PRIZE REEL	SUPER PRIZE REEL
Credit Prizes: 100, 250, 500, 1000, 1500 and 2500 credits multiplied by bet multiplier as displayed.	Credit Prizes: 500, 1000, 1500, 2500, 3750 and 5000 credits multiplied by bet multiplier as displayed.
Multipliers: x2 and x3	Multipliers: x2, x3, x4, and x5
 BONUS and  BONUS	
 JACKPOT and  JACKPOT	



# DEVIL PANDA

# WICKED PANDA



Embrace your devilish side for wicked wins!





**TYPE OF PRODUCT**

[LINK](#) / [SAP](#)

**REEL CONFIGURATION**

5-Reel 3-Row Video Slot

**PAYLINES**

30 Lines

**DENOMINATIONS**

1	2	3
1c	2c	5c
2c	5c	10c
5c	10c	20c
10c	20c	50c
20c	50c	\$1
50c	\$1	\$2
\$1	\$2	\$5

**BET CONFIGURATIONS**

1, 2, 3, 4, 5, 6, 7, 8, 9, 10

**MIN/MAX BET & Cost to Cover**

MIN BET	MAX BET	Cost to Cover
80	800	80

(Instant Trigger: 4000 up to 40000 Bet)  
(Depends on the above Bet Configurations)



**PUMPKIN FEATURE**

PUMPKIN FEATURE consists of BOOST, EXPAND, MULTIPLY.

BOOST will be activated only if  appears in a reel and become BOOST BONUS.

EXPAND will be activated only if  appears in a reel and become EXPAND BONUS.





MULTIPLY will be activated only if  appears in a reel and become MULTIPLY BONUS.



**BOOST FEATURE**

Before BOOST BONUS starts, the  transform to . 1 of the following prizes is displayed on each :

**PRIZE AMOUNT:** 20 to 100 credits multiplied by bet multiplier

BOOST BONUS consists of 3 free spins. During the BOOST BONUS, each symbol position becomes an individual spinning bonus reel. When the BOOST appears on the  above the reel, 2 to 7 prize displayed on held  is randomly boosted by 1 of below prize amount. However if  appear on the  above the reels nothing happens.

**PRIZE AMOUNT:** 20 to 500 credits multiplied by bet multiplier.

During BOOST BONUS, when any appearing  and/or  may trigger EXPAND BONUS, MULTIPLY BONUS and/or EXPAND BONUS + MULTIPLY BONUS. Any new appearing  and/or  resets the number of remaining free spins to 3. Only newly appearing  will be held for the duration of BOOST BONUS.





BOOST BONUS ends after all awarded free spins have been played or if  appears in all 15 symbol positions.









**EXPAND BONUS**

Before EXPAND BONUS starts, the  transform to . 1 of the following prizes is displayed on each :

**PRIZE AMOUNT:** 20 to 100 credits multiplied by bet multiplier.

Before the EXPAND BONUS starts, all reels are expanded upward 2 rows of symbols. BOOST BONUS consists of 3 free spins. During the EXPAND BONUS, each symbol position becomes an individual spinning bonus reel. When the additional prizes appears on the  above the reel, the value of the prize is added to the value of the prize on each held . However if  appear on the  above the reels nothing happens. 1 of the following prizes is will be awarded in .

**PRIZE AMOUNT:** 20 to 100 credits multiplied by bet multiplier.



During EXPAND BONUS, any appearing  and/or  may trigger BOOST BONUS, MULTIPLY BONUS and/or BOOST BONUS + MULTIPLY BONUS. Any new appearing  and/or  resets the number of remaining free spins to 3. Only newly appearing  will be held for the duration of EXPAND BONUS. EXPAND BONUS ends after all awarded free spins have been played or if  appears in all 25 symbol positions.











**MULTIPLY BONUS**

Before MULTIPLY BONUS starts, the  transform to . 1 of the following prizes is displayed on each :

**PRIZE AMOUNT:** 20 to 100 credits multiplied by bet multiplier.



MULTIPLY BONUS consists of 3 free spins. During the MULTIPLY BONUS, each symbol position becomes an individual spinning bonus reel. When the number of multipliers appears on the  above the reel, 1 to 4 prize displayed on held  is randomly multiply by either x2 or x3 except jackpots and bonuses.

However if  appear on the  above the reels nothing happens. During MULTIPLY BONUS, any appearing  and/or  may trigger BOOST BONUS, EXPAND BONUS and/or BOOST BONUS + EXPAND BONUS.

Any new appearing  and/or  resets the number of remaining free spins to 3. Only newly appearing  will be held for the duration of MULTIPLY BONUS. MULTIPLY BONUS ends after all awarded free spins have been played or if  appears in all 15 symbol positions.



**INSTANT TRIGGER**





 can only be played at 4000 credits multiplied by bet multiplier as displayed. 1 of the following features BOOST BONUS, EXPAND BONUS, MULTIPLY BONUS, BOOST BONUS + EXPAND BONUS, BOOST BONUS + MULTIPLY BONUS, EXPAND BONUS + MULTIPLY BONUS and BOOST BONUS + EXPAND BONUS + MULTIPLY BONUS can be randomly awarded by pressing the  button. Choose your bet multiplier.

Selecting  will take you to a confirmation screen to buy the feature.

Selecting  on the confirmation screen will exit and back to the previous screen.

Selecting  will exit the  and confirmation screen.

Selecting  on the confirmation screen will play the .

 is accessible during bought game only. Paytable prizes are not awarded during . Bet multiplier during the  are the same as the game that triggered the .





**TYPE OF PRODUCT**

[LINK](#) / [SAP](#)

**REEL CONFIGURATION**

5-Reel 3-Row Video Slot

**PAYLINES**

30 Lines

**DENOMINATIONS**

1	2	3
1c	2c	5c
2c	5c	10c
5c	10c	20c
10c	20c	50c
20c	50c	\$1
50c	\$1	\$2
\$1	\$2	\$5

**BET CONFIGURATIONS**

1, 2, 3, 4, 5, 6, 7, 8, 9, 10

**MIN/MAX BET & Cost to Cover**

MIN BET	MAX BET	Cost to Cover
80	800	80

(Instant Trigger: 4000 up to 40000 Bet)  
(Depends on the above Bet Configurations)

**PUMPKIN FEATURE**



PUMPKIN FEATURE consists of BOOST, EXPAND, MULTIPLY.

BOOST will be activated only if  appears in a reel and become BOOST BONUS.





EXPAND will be activated only if  appears in a reel and become EXPAND BONUS.

MULTIPLY will be activated only if  appears in a reel and become MULTIPLY BONUS.







**BOOST FEATURE**

Before BOOST BONUS starts, the  transform to . 1 of the following prizes is displayed on each :

**PRIZE AMOUNT:** 20 to 100 credits multiplied by bet multiplier

BOOST BONUS consists of 3 free spins. During the BOOST BONUS, each symbol position becomes an individual spinning bonus reel. When the BOOST appears on the  above the reel, 2 to 7 prize displayed on held  is randomly boosted by 1 of below prize amount. However if  appear on the  above the reels nothing happens.

**PRIZE AMOUNT:** 20 to 500 credits multiplied by bet multiplier.





During BOOST BONUS, when any appearing  and/or  may trigger EXPAND BONUS, MULTIPLY BONUS and/or EXPAND BONUS + MULTIPLY BONUS. Any new appearing   and/or  resets the number of remaining free spins to 3. Only newly appearing  will be held for the duration of BOOST BONUS.

BOOST BONUS ends after all awarded free spins have been played or if  appears in all 15 symbol positions.







**EXPAND BONUS**

Before EXPAND BONUS starts, the  transform to . 1 of the following prizes is displayed on each :

**PRIZE AMOUNT:** 20 to 100 credits multiplied by bet multiplier.

Before the EXPAND BONUS starts, all reels are expanded upward 2 rows of symbols. BOOST BONUS consists of 3 free spins. During the EXPAND BONUS, each symbol position becomes an individual spinning bonus reel. When the additional prizes appears on the  above the reel, the value of the prize is added to the value of the prize on each held . However if  appear on the  above the reels nothing happens. 1 of the following prizes is will be awarded in :



**PRIZE AMOUNT:** 20 to 100 credits multiplied by bet multiplier.





During EXPAND BONUS, any appearing  and/or  may trigger BOOST BONUS, MULTIPLY BONUS and/or BOOST BONUS + MULTIPLY BONUS. Any new appearing   and/or  resets the number of remaining free spins to 3. Only newly appearing  will be held for the duration of EXPAND BONUS. EXPAND BONUS ends after all awarded free spins have been played or if  appears in all 25 symbol positions.





**MULTIPLY BONUS**

Before MULTIPLY BONUS starts, the  transform to . 1 of the following prizes is displayed on each :



**PRIZE AMOUNT:** 20 to 100 credits multiplied by bet multiplier.

MULTIPLY BONUS consists of 3 free spins. During the MULTIPLY BONUS, each symbol position becomes an individual spinning bonus reel. When the number of multipliers appears on the  above the reel, 1 to 4 prize displayed on held  is randomly multiply by either x2 or x3 except jackpots and bonuses.

However if  appear on the  above the reels nothing happens. During MULTIPLY BONUS, any appearing  and/or  may trigger BOOST BONUS, EXPAND BONUS and/or BOOST BONUS + EXPAND BONUS.

Any new appearing   and/or  resets the number of remaining free spins to 3. Only newly appearing  will be held for the duration of MULTIPLY BONUS. MULTIPLY BONUS ends after all awarded free spins have been played or if  appears in all 15 symbol positions.

**INSTANT TRIGGER**





 can only be played at 4000 credits multiplied by bet multiplier as displayed. 1 of the following features BOOST BONUS, EXPAND BONUS, MULTIPLY BONUS, BOOST BONUS + EXPAND BONUS, BOOST BONUS + MULTIPLY BONUS, EXPAND BONUS + MULTIPLY BONUS and BOOST BONUS + EXPAND BONUS + MULTIPLY BONUS can be randomly awarded by pressing the  button. Choose your bet multiplier.

Selecting  will take you to a confirmation screen to buy the feature.

Selecting  on the confirmation screen will exit and back to the previous screen.

Selecting  will exit the  and confirmation screen.

Selecting  on the confirmation screen will play the .

 is accessible during bought game only. Paytable prizes are not awarded during . Bet multiplier during the  are the same as the game that triggered the .







New honeycomb LED (Details)



New vertical 55-inch J-Style curved LCD monitor



New Face Design



**MUSO™**  
CURVE-55HB

Being the only one of its kind; unlike anything else.

A stunning new honeycomb cabinet LED display to attract players.

Thoughtful touches to keep them comfortable.

All designed for an unparalleled 55-inch full screen dynamic gaming experience.

### DIMENSION

**Upright Height**  
(Tower Light Included)  
2756.9 mm (108.3 in)

**Upright Height**  
(Tower Light Excluded)  
2652.5 mm (104.4 in)

**Width**  
810 mm (31.9 in)

**Depth**  
838.2 mm (33 in)

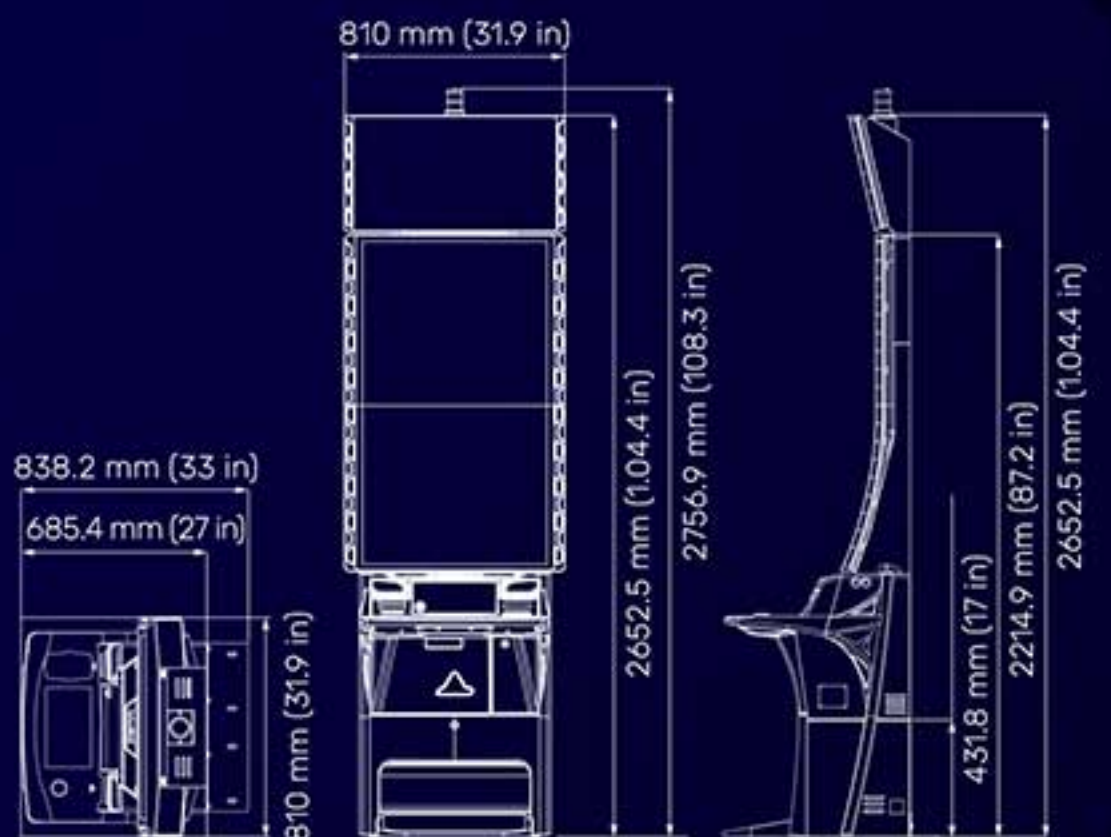

**BUILT FOR EXCELLENCE**

Please contact your Account Executive for more details.

sales@aruzeglobal.com

+1 702-781-8080

www.aruzeglobal.com

Follow us @AruzeGaming   



Empire Technological Group Ltd dba  
Aruze Gaming Global



# TRIPLE TREASURE POT™



Win big  
with a wealth of  
multiple features!





Also available in other Cabinets



**TYPE OF PRODUCT**

[LINK](#) / [SAP](#)

**REEL CONFIGURATION**

5-Reel 4-Row Video Slot  
5-Reel 6-Row (During the Ox Feature only)

**PAYLINES**

50 Lines  
100 Lines (During the Ox Feature only)

**DENOMINATIONS**

1	2	3
1c	2c	5c
10c	20c	50c
\$1	\$2	\$5

**BET CONFIGURATIONS**

1, 2, 3, 6, 10

**MIN/MAX BET & Cost to Cover**

MIN BET	MAX BET	Cost to Cover	Denomination
88	880	88	Denomination 1
88	528	88	Denomination 2
88	264	88	Denomination 3

(Depends on the above Bet Configurations)



**TIGER FEATURE**



There is a chance that the TIGER FEATURE is triggered when 1 or more appear. TIGER FEATURE awards 5 free spins. Any reel with 1, 2 or 3 nudges to show 4 when any ACTION SYMBOL appears on reel 5. Line wins are determined only once before any reel nudge occurs. Prizes on are won only once after any reel nudge occurs. Any other FEATURE triggered during the TIGER FEATURE starts after the TIGER FEATURE ends, except ACTION PRIZES FEATURE.

**DRAGON FEATURE**



There is a chance that the DRAGON FEATURE is triggered when 1 or more appear. DRAGON FEATURE awards 10 free spins. Different reels are used during the DRAGON FEATURE. 1 of the following is displayed on each .

- CREDIT PRIZE: 100, 500 or 1000 credits multiplied by bet multiplier as displayed.
- MINI, MINOR, MAJOR or GRAND

Each CREDIT PRIZE displayed on is won. Each MINI, MINOR, MAJOR or GRAND displayed on is collected in its corresponding meter on the screen. Each appearing awards 1 additional free spin and up to 5 can be awarded only.

**OX FEATURE**



There is a chance that the OX FEATURE is triggered when 1 or more appear. OX FEATURE awards 5 free spins. Different reels are used during the OX FEATURE. Before the OX FEATURE starts, all reels are expanded upward 2 rows of symbols. Any other FEATURE triggered during the OX FEATURE starts after the OX FEATURE ends, except ACTION PRIZES FEATURE.

**ACTION PRIZES FEATURE**



Any combination of 1 or more and 1 ACTION SYMBOL trigger the corresponding ACTION PRIZE shown below.

ACTION SYMBOL	ACTION PRIZE
	Each prize displayed  is won.
	Each prize displayed on  is won after being increased by the credit value displayed on .
	Each displayed on  is won after being multiplied by the multiplier displayed on .





Also available in other Cabinets



**TYPE OF PRODUCT**

LINK / SAP

**REEL CONFIGURATION**

5-Reel 4-Row Video Slot  
5-Reel 6-Row (During the Ox Feature only)

**PAYLINES**

50 Lines  
100 Lines (During the Ox Feature only)

**DENOMINATIONS**

1	2	3
1c	2c	5c
10c	20c	50c
\$1	\$2	\$5

**BET CONFIGURATIONS**

1, 2, 3, 6, 10

**MIN/MAX BET & Cost to Cover**

MIN BET	MAX BET	Cost to Cover	Denomination
88	880	88	Denomination 1
88	528	88	Denomination 2
88	264	88	Denomination 3

(Depends on the above Bet Configurations)



**TIGER FEATURE**



There is a chance that the TIGER FEATURE is triggered when 1 or more appear. TIGER FEATURE awards 5 free spins. Any reel with 1, 2 or 3 nudges to show 4 when any ACTION SYMBOL appears on reel 5. Line wins are determined only once before any reel nudge occurs. Prizes on are won only once after any reel nudge occurs. Any other FEATURE triggered during the TIGER FEATURE starts after the TIGER FEATURE ends, except ACTION PRIZES FEATURE.

**DRAGON FEATURE**



There is a chance that the DRAGON FEATURE is triggered when 1 or more appear. DRAGON FEATURE awards 10 free spins. Different reels are used during the DRAGON FEATURE. 1 of the following is displayed on each :

- CREDIT PRIZE: 100, 500 or 1000 credits multiplied by bet multiplier as displayed.
- MINI, MINOR, MAJOR or GRAND

Each CREDIT PRIZE displayed on is won. Each MINI, MINOR, MAJOR or GRAND displayed on is collected in its corresponding meter on the screen. Each appearing awards 1 additional free spin and up to 5 can be awarded only.

**OX FEATURE**



There is a chance that the OX FEATURE is triggered when 1 or more appear. OX FEATURE awards 5 free spins. Different reels are used during the OX FEATURE. Before the OX FEATURE starts, all reels are expanded upward 2 rows of symbols. Any other FEATURE triggered during the OX FEATURE starts after the OX FEATURE ends, except ACTION PRIZES FEATURE.

**ACTION PRIZES FEATURE**



Any combination of 1 or more and 1 ACTION SYMBOL trigger the corresponding ACTION PRIZE shown below.

ACTION SYMBOL	ACTION PRIZE
	Each prize displayed  is won.
	Each prize displayed on  is won after being increased by the credit value displayed on .
	Each displayed on  is won after being multiplied by the multiplier displayed on .



# LONG FUZHU



Feel the heat  
of the dragon's  
breath unlocking  
superb wins!





Also available in other Cabinets



**TYPE OF PRODUCT**

LINK / SAP

**REEL CONFIGURATION**

5-Reel 3-Row Video Slot

**PAYLINES**

50 Lines (Denomination 1, 2)  
25 Lines (Denomination 3, 4, 5)  
5 Lines (Denomination 6, 7, 8)

**DENOMINATIONS**

1	2	3	4	5	6	7	8
1c	2c	5c	10c	20c	\$1	\$2	\$5
5c	10c	25c	50c	\$1	\$5	\$10	\$25
10c	20c	50c	\$1	\$2	\$10	\$20	\$50
50c	\$1	\$2.50	\$5	\$10	\$50	\$100	\$250
\$1	\$2	\$5	\$10	\$20	\$100	\$200	\$500

**BET CONFIGURATIONS**

1, 2, 3, 4, 5  
1, 2, 3, 5, 8  
1, 2, 3, 5, 10  
1, 2, 5, 10, 20

**MIN/MAX BET & Cost to Cover**

MIN BET	MAX BET	Cost to Cover	Denomination
80	1600	80	Denomination 1, 2
40	800	40	Denomination 3, 4, 5
8	160	8	Denomination 6, 7, 8

(Depends on the above Bet Configurations)



**FREE GAMES FEATURE**



Any 3 appearing on reels 2, 3 and 4 trigger the FREE GAMES FEATURE with 6 free games. Reels used during the FREE GAMES FEATURE contain a greater total number of .

FREE GAMES FEATURE can be triggered again during the FREE GAMES FEATURE. FREE GAMES FEATURE starts after the DRAGON ORB FEATURE ends if triggered in the same game. If triggered in the same game, the FREE GAMES FEATURE starts after the DRAGON ORB FEATURE ends.

**DRAGON ORB FEATURE**



Any 6 or more appearing in a bought game or free game trigger the DRAGON ORB FEATURE. When DRAGON ORB FEATURE is triggered, 3 free spins are awarded. During the DRAGON ORB FEATURE, each symbol position becomes an individual spinning bonus reel.

Before the DRAGON ORB FEATURE starts, all reels are expanded upward 1 row of symbols and reel 5 is locked. In each free spin, reel 5 is locked if no new appearing on the reels. At the start of DRAGON ORB FEATURE, only 6 appear on random symbol positions on reels 1, 2, 3 and 4 and are held in the position for the duration of the DRAGON ORB FEATURE. In each free spin, any newly appearing unlock reel 5 for that spin only. Any newly appearing in a free spin unlocks the reel 5, and resets the number of remaining free spins to 3 and is held in position until the DRAGON ORB FEATURE ends.

PRIZES	ACTION PRIZE
<b>MULTIPLIER</b> x2, x3 or x8	Each prize displayed on held  appearing on the same row in which the MULTIPLIER appears is being multiplied by that MULTIPLIER.
<b>PRIZE AMOUNT (50 LINES)</b> each equal to 5, 40, 80, 160, 100, 200 or 250 credits multiplied by bet multiplier as displayed	Each prize displayed on held  appearing on the same row in which the PRIZE AMOUNT appears is increased by that PRIZE AMOUNT.
<b>PRIZE AMOUNT (25 LINES)</b> each equal to 5, 20, 25, 40, 60, 75, 100 or 125 credits multiplied by bet multiplier as displayed	Each prize displayed on held  appearing on the same row in which the PRIZE AMOUNT appears is increased by that PRIZE AMOUNT.
<b>PRIZE AMOUNT (5 lines)</b> each equal to 5, 4, 5, 5, 15, 15, 20 or 25 credits multiplied by bet multiplier as displayed	Each prize displayed on held  appearing on the same row in which the PRIZE AMOUNT appears is increased by that PRIZE AMOUNT.
<b>BONUS</b> x2, x3 or x8	Each prize displayed on held  appearing on the same row in which the BONUS appears is increased by that BONUS.

When the reel 5 unlocks, it will spin automatically and each symbol position displayed one of the available prizes. DRAGON ORB FEATURE ends after all awarded free spins have been played or if appear in all 16 symbol positions on reels 1, 2, 3 and 4.



**MYSTERY JACKPOT AWARD**

There is a chance that the GRAND JACKPOT is randomly won in bought games except when FREE GAMES FEATURE or DRAGON ORB FEATURE is triggered.





Also available in other Cabinets



**TYPE OF PRODUCT**

LINK / SAP

**REEL CONFIGURATION**

5-Reel 3-Row Video Slot

**PAYLINES**

50 Lines (Denomination 1, 2)  
25 Lines (Denomination 3, 4, 5)  
5 Lines (Denomination 6, 7, 8)

**DENOMINATIONS**

1	2	3	4	5	6	7	8
1c	2c	5c	10c	20c	\$1	\$2	\$5
5c	10c	25c	50c	\$1	\$5	\$10	\$25
10c	20c	50c	\$1	\$2	\$10	\$20	\$50
50c	\$1	\$2.50	\$5	\$10	\$50	\$100	\$250
\$1	\$2	\$5	\$10	\$20	\$100	\$200	\$500

**BET CONFIGURATIONS**

1, 2, 3, 4, 5  
1, 2, 3, 5, 8  
1, 2, 3, 5, 10  
1, 2, 5, 10, 20

**MIN/MAX BET & Cost to Cover**

MIN BET	MAX BET	Cost to Cover	Denomination
80	1600	80	Denomination 1, 2
40	800	40	Denomination 3, 4, 5
8	160	8	Denomination 6, 7, 8

(Depends on the above Bet Configurations)



**FREE GAMES FEATURE**



Any 3 appearing on reels 2, 3 and 4 trigger the FREE GAMES FEATURE with 6 free games. During the FREE GAMES FEATURE, substituting in a win becomes . The sum of multipliers from every that substitutes in a win multiplies the pay for that win. FREE GAMES FEATURE can be triggered again during the FREE GAMES FEATURE. FREE GAMES FEATURE starts after the DRAGON ORB FEATURE ends if triggered in the same game. If triggered in the same game, the FREE GAMES FEATURE starts after the DRAGON ORB FEATURE ends.

**DRAGON ORB FEATURE**



Any 6 or more appearing in a bought game or free game trigger the DRAGON ORB FEATURE. When DRAGON ORB FEATURE is triggered, 3 free spins are awarded. During the DRAGON ORB FEATURE, each symbol position becomes an individual spinning bonus reel.

Before the DRAGON ORB FEATURE starts, all reels are expanded upward 1 row of symbols and reel 5 is locked. In each free spin, reel 5 is locked if no new appearing on the reels. At the start of DRAGON ORB FEATURE, only 6 appear on random symbol positions on reels 1, 2, 3 and 4 and are held in the position for the duration of the DRAGON ORB FEATURE. In each free spin, any newly appearing unlock reel 5 for that spin only. Any newly appearing in a free spin unlocks the reel 5, and resets the number of remaining free spins to 3 and is held in position until the DRAGON ORB FEATURE ends.

PRIZES	ACTION PRIZE
<b>MULTIPLIER</b> x2, x3 or x8	Each prize displayed on held  appearing on the same row in which the MULTIPLIER appears is being multiplied by that MULTIPLIER.
<b>PRIZE AMOUNT (50 LINES)</b> each equal to 5, 40, 80, 90, 100, 100, 200 or 250 credits multiplied by bet multiplier as displayed	Each prize displayed on held  appearing on the same row in which the PRIZE AMOUNT appears is increased by that PRIZE AMOUNT.
<b>PRIZE AMOUNT (25 LINES)</b> each equal to 5, 20, 25, 40, 60, 70, 100 or 125 credits multiplied by bet multiplier as displayed	Each prize displayed on held  appearing on the same row in which the PRIZE AMOUNT appears is increased by that PRIZE AMOUNT.
<b>PRIZE AMOUNT (5 lines)</b> each equal to 5, 4, 5, 8, 10, 15, 20 or 25 credits multiplied by bet multiplier as displayed	Each prize displayed on held  appearing on the same row in which the PRIZE AMOUNT appears is increased by that PRIZE AMOUNT.
<b>BONUS</b> MINOR or MAJOR	Each prize displayed on held  appearing on the same row in which the BONUS appears is increased by that BONUS.

When the reel 5 unlocks, it will spin automatically and each symbol position displayed one of the available prizes. DRAGON ORB FEATURE ends after all awarded free spins have been played or if appear in all 16 symbol positions on reels 1, 2, 3 and 4.



**MYSTERY JACKPOT AWARD**

There is a chance that the GRAND JACKPOT is randomly won in bought games except when FREE GAMES FEATURE or DRAGON ORB FEATURE is triggered.



# XINYUNQIU™



The powerful orb  
brings extraordinary  
fortunes!





Also available in other Cabinets



**TYPE OF PRODUCT**

LINK / SAP

**REEL CONFIGURATION**

5-Reel 3-4-4-4-3-Row Video Slot

**PAYLINES**

32 Lines

**DENOMINATIONS**

1c

**BET CONFIGURATIONS**

1, 2, 3, 4, 5, 6, 7, 8, 9, 10

**MIN/MAX BET & Cost to Cover**

MIN BET	MAX BET	Cost to Cover
88	880	88

(Depends on the above Bet Configurations)



**WILD HOLD FEATURE**

3 scattered appearing on reels 2, 3 and 4 trigger WILD HOLD FEATURE with 6 free spins.

Reels that triggered WILD HOLD FEATURE are held during the entirety of WILD HOLD FEATURE. Similarly, when WILD HOLD FEATURE triggered inside JACKPOT FEATURE, reels that triggered the JACKPOT FEATURE will use.

symbol change to WILD after reel stop are held until all free spins have been awarded.

The sum of multipliers from every / / / / that substitutes in a win multiplies the pay for that win. No wins for any combination during the free spins. All wins for WILD HOLD FEATURE are determined after the last free spin. However during JACKPOT FEATURE any coinciding win will be award first before proceeding to WILD HOLD FEATURE. WILD HOLD FEATURE start after the JACKPOT FEATURE ends if triggered in the same bought game.



**FREE GAMES FEATURE**

3 on reels 1, 3 and 5 trigger 7 FREE GAMES. FREE GAMES start after the JACKPOT FEATURE end if triggered in the same bought game. Bet Multiplier during the FREE GAME is same as the game that triggered the FREE GAME.

**RANDOM WILD REEL**

There is a chance that change to / / or after reel stop. The sum of multipliers from every / / / that substitutes in a win multiplies the pay for that win.



**JACKPOT FEATURE**

There is a chance that the JACKPOT FEATURE may be triggered when 1 or more appear in bought games only. In the JACKPOT FEATURE, there are 4 types of jackpot and WILD HOLD BONUS symbols hidden behind 15 icons. Select an icon until 3 matching symbol corresponding to JACKPOT or WILD HOLD BONUS are revealed.

When 3 matching jackpot symbol has been revealed, the corresponding JACKPOT is won and JACKPOT FEATURE ends. However when 3 matching has been revealed, proceed to WILD HOLD FEATURE and JACKPOT FEATURE ends. The chances of revealing each jackpot or Bonus icons are not equal.



**MYSTERY CREDIT AWARD**

There is a chance that the MYSTERY CREDIT AWARD may occur in bought games only when is not stopped.

MYSTERY CREDIT AWARD is 15,000 credits, and multiplied by bet multiplier as displayed are awarded.





Also available in other Cabinets



**TYPE OF PRODUCT**

LINK / SAP

**REEL CONFIGURATION**

5-Reel 3-4-4-4-3-Row Video Slot

**PAYLINES**

32 Lines

**DENOMINATIONS**

1c

**BET CONFIGURATIONS**

1, 2, 3, 4, 5, 6, 7, 8, 9, 10

**MIN/MAX BET & Cost to Cover**

MIN BET	MAX BET	Cost to Cover
88	880	88

(Depends on the above Bet Configurations)



**WILD HOLD FEATURE**

3 scattered appearing on reels 2, 3 and 4 trigger WILD HOLD FEATURE with 6 free spins.

Reels that triggered WILD HOLD FEATURE are held during the entirety of WILD HOLD FEATURE. Similarly, when WILD HOLD FEATURE triggered inside JACKPOT FEATURE, reels that triggered the JACKPOT FEATURE will use.

symbol change to WILD after reel stop are held until all free spins have been awarded.

The sum of multipliers from every / / / / that substitutes in a win multiplies the pay for that win. No wins for any combination during the free spins. All wins for WILD HOLD FEATURE are determined after the last free spin. However during JACKPOT FEATURE any coinciding win will be award first before proceeding to WILD HOLD FEATURE. WILD HOLD FEATURE start after the JACKPOT FEATURE ends if triggered in the same bought game.



**FREE GAMES FEATURE**

3 on reels 1, 3 and 5 trigger 7 FREE GAMES. FREE GAMES start after the JACKPOT FEATURE end if triggered in the same bought game. Bet Multiplier during the FREE GAME is same as the game that triggered the FREE GAME.

**EXTRA RANDOM WILD**

During reel spin, or may randomly add on the reel. The sum of multipliers from every / that substitutes in a win multiplies the pay for that win.



**JACKPOT FEATURE**

There is a chance that the JACKPOT FEATURE may be triggered when 1 or more appear in bought games only. In the JACKPOT FEATURE, there are 4 types of jackpot and WILD HOLD BONUS symbols hidden behind 15 icons. Select an icon until 3 matching symbol corresponding to JACKPOT or WILD HOLD BONUS are revealed.

When 3 matching jackpot symbol has been revealed, the corresponding JACKPOT is won and JACKPOT FEATURE ends. However when 3 matching has been revealed, proceed to WILD HOLD FEATURE and JACKPOT FEATURE ends. The chances of revealing each jackpot or Bonus icons are not equal.



**MYSTERY CREDIT AWARD**

There is a chance that the MYSTERY CREDIT AWARD may occur in bought games only when is not stopped.

MYSTERY CREDIT AWARD is 15,000 credits, and multiplied by bet multiplier as displayed are awarded.



# BINGO JACKPOT™



The thrill  
of the bingo game  
enhanced with additional  
exciting features!





Also available in other Cabinets



**TYPE OF PRODUCT**

[LINK](#) / [SAP](#)

**REEL CONFIGURATION**

5-Reel 3-Row Video Slot  
(Up to 5-Reel 5-Rows during the BINGO Collect Feature)

**PAYLINES**

50 Lines

**DENOMINATIONS**

1c

**BET CONFIGURATIONS**

- 1, 2, 3, 4, 5
- 1, 2, 3, 4, 6
- 1, 2, 3, 4, 8
- 1, 2, 3, 5, 8
- 1, 2, 3, 5, 10
- 1, 2, 3, 6, 10

**MIN/MAX BET & Cost to Cover**

MIN BET	MAX BET	Cost to Cover
50	1000	50

(Depends on the above Bet Configurations)



**FREE GAMES FEATURE**



Any 3 or more trigger FREE GAMES FEATURE with 6 free games.

Different reels are used during the FREE GAMES FEATURE. FREE GAMES FEATURE can be triggered again during the FREE GAMES FEATURE.

FREE GAMES FEATURE starts after COLLECT FEATURE or BINGO COLLECT FEATURE ends if triggered in the same game.

**COLLECT FEATURE**



In bought games and FREE GAMES FEATURE, 6 or more prize symbols trigger COLLECT FEATURE.

However when appears in center position of reel 3, all prize shown in the reel will be awarded first before COLLECT FEATURE start. Any prize symbols appearing in the game that trigger the COLLECT FEATURE are held in position for the duration of the COLLECT FEATURE.

Each symbol position becomes an individual spinning bonus reel during the COLLECT FEATURE.

When the COLLECT FEATURE is triggered, 3 free spins are awarded. Each newly appearing prize symbol in a free spin resets the number of remaining free spins to 3 and is held in position until the COLLECT FEATURE ends.

During the COLLECT FEATURE, when appears on the center position of reel 3 BINGO COLLECT FEATURE is triggered. COLLECT FEATURE ends after all awarded free spins have been played or if BINGO COLLECT FEATURE is triggered.

**BINGO COLLECT FEATURE**



During base game and FREE GAME FEATURE, 5 or more prize symbol with appears on the center position of reel 3 triggers BINGO COLLECT FEATURE.

All prize symbol appearing in the game that triggers the BINGO COLLECT FEATURE are held in position for the duration of the BINGO COLLECT FEATURE.

Any newly appearing prize symbol in a free spin resets the number of remaining free spins to 3 and is held in position until the BINGO COLLECT FEATURE ends.

When the BINGO COLLECT FEATURE is triggered, 3 free spins are awarded. All reels are expanded to 5 symbol positions during the BINGO COLLECT FEATURE.

Each symbol position becomes an individual spinning bonus reel during the BINGO COLLECT FEATURE.

BINGO LINE wins are only paid at the end of the BINGO COLLECT FEATURE, with the highest BINGO LINE wins paid only. BINGO COLLECT FEATURE ends after all awarded free spins have been played or if BINGO LINE 12 is formed.





Also available in other Cabinets



**TYPE OF PRODUCT**

[LINK](#) / [SAP](#)

**REEL CONFIGURATION**

5-Reel 3-Row Video Slot  
(Up to 5-Reel 5-Rows during the Bingo Collect Feature)

**PAYLINES**

50 Lines

**DENOMINATIONS**

1c

**BET CONFIGURATIONS**

- 1, 2, 3, 4, 5
- 1, 2, 3, 4, 6
- 1, 2, 3, 4, 8
- 1, 2, 3, 5, 8
- 1, 2, 3, 5, 10
- 1, 2, 3, 6, 10

**MIN/MAX BET & Cost to Cover**

MIN BET	MAX BET	Cost to Cover
50	1000	50

(Depends on the above Bet Configurations)



**FREE GAMES FEATURE**



Any 3 or more trigger FREE GAMES FEATURE with 6 free games.

Different reels are used during the FREE GAMES FEATURE. FREE GAMES FEATURE can be triggered again during the FREE GAMES FEATURE.

FREE GAMES FEATURE starts after COLLECT FEATURE or BINGO COLLECT FEATURE ends if triggered in the same game.

**COLLECT FEATURE**



In bought games and FREE GAMES FEATURE, 6 or more prize symbols trigger COLLECT FEATURE.

However when appears in center position of reel 3, all prize shown in the reel will be awarded first before COLLECT FEATURE start. Any prize symbols appearing in the game that trigger the COLLECT FEATURE are held in position for the duration of the COLLECT FEATURE.

Each symbol position becomes an individual spinning bonus reel during the COLLECT FEATURE.

When the COLLECT FEATURE is triggered, 3 free spins are awarded. Each newly appearing prize symbol in a free spin resets the number of remaining free spins to 3 and is held in position until the COLLECT FEATURE ends.

During the COLLECT FEATURE, when appears on the center position of reel 3 BINGO COLLECT FEATURE is triggered. COLLECT FEATURE ends after all awarded free spins have been played or if BINGO COLLECT FEATURE is triggered.

**BINGO COLLECT FEATURE**



During base game and FREE GAME FEATURE, 5 or more prize symbol with appears on the center position of reel 3 triggers BINGO COLLECT FEATURE.

All prize symbol appearing in the game that triggers the BINGO COLLECT FEATURE are held in position for the duration of the BINGO COLLECT FEATURE.

Any newly appearing prize symbol in a free spin resets the number of remaining free spins to 3 and is held in position until the BINGO COLLECT FEATURE ends.

When the BINGO COLLECT FEATURE is triggered, 3 free spins are awarded. All reels are expanded to 5 symbol positions during the BINGO COLLECT FEATURE.

Each symbol position becomes an individual spinning bonus reel during the BINGO COLLECT FEATURE.

BINGO LINE wins are only paid at the end of the BINGO COLLECT FEATURE, with the highest BINGO LINE wins paid only. BINGO COLLECT FEATURE ends after all awarded free spins have been played or if BINGO LINE 12 is formed.



# POWER TOWER™



Play higher and  
unlock your chances  
for bigger fortunes  
with special symbols!





Also available in other Cabinets



**TYPE OF PRODUCT**

[LINK](#) / [SAP](#)

**REEL CONFIGURATION**

5-Reel 4-4-5-4-4 Row Video Slot

**PAYLINES**

50 Lines

**DENOMINATIONS**

1c

**BET CONFIGURATIONS**

1, 2, 3, 4, 5  
1, 2, 3, 5, 10

**MIN/MAX BET & Cost to Cover**

MIN BET	MAX BET	Cost to Cover
75	975	175

(Depends on the above Bet Configurations)



**HIGHER BETS HAVE BETTER LOCK IN FEATURE BONUS CHANCE**

**ORB POWER FEATURE**



Any 6 or more scattered or a combination of and triggers the ORB POWER FEATURE.  
 During ORB POWER FEATURE, all symbol positions become individual spinning bonus reels.  
 Any that triggers ORB POWER FEATURE or appear during ORB POWER FEATURE are held for the duration of ORB POWER FEATURE.  
 The symbols will be removed once the feature begins.  
 When ORB POWER FEATURE is triggered, 5 free spins are awarded.  
 1 of the following available prizes is displayed on each :

- Prize Amount
- Bonus: MINOR BONUS or MINI BONUS
- Jackpot: GRAND JACKPOT or MAJOR JACKPOT

and may also be awarded during ORB POWER FEATURE.  
: Unlocks 1 reel window on the reel directly above where the appears.  
 (All prizes in the unlocked reel window will be awarded after the ORB POWER FEATURE)  
: Awards 1 additional spin.

**LOCK IN FEATURE**



There is a chance that LOCK IN FEATURE may be triggered when any or appears on a reel.  
 During bought games, when or appears on a reel and triggers the LOCK IN FEATURE, the corresponding upper reel will be unlocked.  
 When LOCK IN FEATURE is triggered, 5 free spins are awarded.  
 All prizes in the unlocked reel windows will be awarded after the LOCK IN FEATURE has completed.  
 Any unlocked bonus symbol reel is locked again after LOCK IN FEATURE ends.





Also available in other Cabinets



**TYPE OF PRODUCT**

[LINK](#) / [SAP](#)

**REEL CONFIGURATION**

5-Reel 4-4-5-4-4 Row Video Slot

**PAYLINES**

50 Lines

**DENOMINATIONS**

1c

**BET CONFIGURATIONS**

1, 2, 3, 4, 5  
1, 2, 3, 5, 10

**MIN/MAX BET & Cost to Cover**

MIN BET	MAX BET	Cost to Cover
75	975	175

(Depends on the above Bet Configurations)



**HIGHER BETS HAVE BETTER LOCK IN FEATURE BONUS CHANCE**

**ORB POWER FEATURE**



Any 6 or more scattered or a combination of and triggers the ORB POWER FEATURE.

During ORB POWER FEATURE, all symbol positions become individual spinning bonus reels.

Any that triggers ORB POWER FEATURE or appear during ORB POWER FEATURE are held for the duration of ORB POWER FEATURE.

The symbols will be removed once the feature begins.

When ORB POWER FEATURE is triggered, 5 free spins are awarded.

1 of the following available prizes is displayed on each :

- Prize Amount
- Bonus: MINOR BONUS or MINI BONUS
- Jackpot: GRAND JACKPOT or MAJOR JACKPOT

and may also be awarded during ORB POWER FEATURE.

: Unlocks 1 reel window on the reel directly above where the appears.

(All prizes in the unlocked reel window will be awarded after the ORB POWER FEATURE)

: Awards 1 additional spin.

**LOCK IN FEATURE**



There is a chance that LOCK IN FEATURE may be triggered when any or appears on a reel. During bought games, when or appears on a reel and triggers the LOCK IN FEATURE, the corresponding upper reel will be unlocked.

When LOCK IN FEATURE is triggered, 5 free spins are awarded.

All prizes in the unlocked reel windows will be awarded after the LOCK IN FEATURE has completed.

Any unlocked bonus symbol reel is locked again after LOCK IN FEATURE ends.



# DOUBLE FIRESTORM™



**Special fireball  
symbols unlocking rows  
and awarding  
blazing prizes!**





**PLAY HIGHER BET FOR DOUBLE THE PRIZES!**

Also available in other Cabinets



**TYPE OF PRODUCT**

[LINK](#) / [SAP](#)

**REEL CONFIGURATION**

5-Reel 4-Row Video Slot  
(Up to 10 rows during RISING FIRE)

**PAYLINES**

50 Lines

**DENOMINATIONS**

1	2	3	4	5
1c	2c	5c	10c	20c
5c	10c	25c	50c	\$1
10c	20c	50c	\$1	\$2
50c	\$1	\$2.50	\$5	\$10
\$1	\$2	\$5	\$10	\$20

**BET CONFIGURATIONS**

1, 2, 3, 4, 5, 8, 10

**MIN/MAX BET & Cost to Cover**

MIN BET	MAX BET	Cost to Cover	BET LEVEL
75	975	75	Bet Level 1
85	1075	85	Bet Level 2

(Depends on the above Bet Configurations)



**FREE GAMES FEATURE**

appearing on 3 or more consecutive reels beginning with the leftmost reel trigger the FREE GAMES FEATURE. The sum of the numbers that appeared is awarded as FREE GAMES in the FREE GAMES FEATURE.

When the FREE GAMES FEATURE is triggered, a number appears on each that was involved in triggering the feature. 1, 2, 3, 5, 7 or 10 free games are awarded for each .

If RISING FIRE is triggered during the FREE GAMES FEATURE, any remaining free games resume after RISING FIRE ends.



**MYSTERY SYMBOL**

During bought games, appearing on the reels changes to after all reels finish spinning.

During FREE GAMES FEATURE, appearing on the reels changes to or after all reels finish spinning. All appearing in the same game randomly change to the same symbol. If appears, wins are determined after finishes changing.

**IMPROVED JACKPOTS PER PLAY**

Reels containing improved jackpots symbols can be played. When Game is played with Bet Level 2, the jackpot prize and bonus prize changes as described below:

- and : Initial value is doubled as displayed.
- and : Value is doubled as displayed



**RISING FIRE**

Any 6 or more / in a bought game or free game trigger RISING FIRE. During RISING FIRE, all symbol positions become individual spinning bonus reels. Any that trigger RISING FIRE or appear during RISING FIRE are held for the duration of RISING FIRE. Any that trigger RISING FIRE or appear during RISING FIRE decrease the remaining number of needed to unlock bonus symbol rows and decrease the number of remaining needed to win the UP UP JACKPOT. When RISING FIRE is triggered, 3 free spins are awarded. Each newly appearing / in a free spin resets the number of remaining free spins to 3. RISING FIRE ends after all awarded free spins have been played

or if fills every symbol position. Any unlocked bonus symbol row is locked again after RISING FIRE ends. The number of remaining required to unlock any bonus symbol row is reset after RISING FIRE ends. The number of remaining required to win the UP UP JACKPOT is reset after RISING FIRE ends.

**JACKPOT SURPRISE RISING FIRE**



There is a chance that 1 JACKPOT is randomly won in bought games except when FREE GAMES FEATURE or RISING FIRE is triggered.

**NORMAL BET**



**HIGHER BET**



**PLAY HIGHER BET FOR INCREASED JACKPOTS AND BONUSES!**





**PLAY HIGHER BET FOR DOUBLE THE PRIZES!**

Also available in other Cabinets



**TYPE OF PRODUCT**

[LINK](#) / [SAP](#)

**REEL CONFIGURATION**

5-Reel 4-Row Video Slot  
(Up to 10 rows during RISING FIRE)

**PAYLINES**

50 Lines

**DENOMINATIONS**

1	2	3	4	5
1c	2c	5c	10c	20c
5c	10c	25c	50c	\$1
10c	20c	50c	\$1	\$2
50c	\$1	\$2.50	\$5	\$10
\$1	\$2	\$5	\$10	\$20

**BET CONFIGURATIONS**

1, 2, 3, 4, 5, 8, 10

**MIN/MAX BET & Cost to Cover**

MIN BET	MAX BET	Cost to Cover	BET LEVEL
75	975	75	Bet Level 1
85	1075	85	Bet Level 2

(Depends on the above Bet Configurations)



**FREE GAMES FEATURE**

appearing on 3 or more consecutive reels beginning with the leftmost reel trigger the FREE GAMES FEATURE. When the FREE GAMES FEATURE is triggered, a number appears on each that was involved in triggering the feature.

1, 2, 3, 5, 7 or 10 free games are awarded for each .

The sum of the numbers that appeared is awarded as FREE GAMES in the FREE GAMES FEATURE. FREE GAMES FEATURE can be triggered again during the FREE GAMES FEATURE. FREE GAMES FEATURE starts after RISING FIRE ends if triggered in the same game. If RISING FIRE is triggered during the FREE GAMES FEATURE, any remaining free games resume after RISING FIRE ends.



**MYSTERY SYMBOL**

appearing on the reels changes to , , , , , , , or after all reels finish spinning.

All appearing in the same game randomly change to the same symbol.

If appears, wins are determined after finishes changing.

Does not appear during RISING FIRE.

**IMPROVED JACKPOTS PER PLAY**

Reels containing improved jackpots symbols can be played. When Game is played with Bet Level 2, the jackpot prize and bonus prize changes as described below:

and : Initial value is doubled as displayed.

and : Value is doubled as displayed



**RISING FIRE**

Any 6 or more / in a bought game or free game trigger RISING FIRE. During RISING FIRE, all symbol positions become individual spinning bonus reels.

Any that trigger RISING FIRE or appear during RISING FIRE are held for the duration of RISING FIRE. Any that trigger RISING FIRE or appear during RISING FIRE decrease the remaining number of needed to unlock bonus symbol rows and decrease the number of remaining needed to win the UP UP JACKPOT. When RISING FIRE is triggered, 3 free spins are awarded. Each newly appearing / in a free spin resets the number of remaining free spins to 3. RISING FIRE ends after all awarded free spins have been played

or if fills every symbol position. Any unlocked bonus symbol row is locked again after RISING FIRE ends. The number of remaining required to unlock any bonus symbol row is reset after RISING FIRE ends. The number of remaining required to win the UP UP JACKPOT is reset after RISING FIRE ends.

**JACKPOT SURPRISE RISING FIRE**



There is a chance that 1 JACKPOT is randomly won in bought games except when FREE GAMES FEATURE or RISING FIRE is triggered.

**NORMAL BET**



**HIGHER BET**



**PLAY HIGHER BET FOR INCREASED JACKPOTS AND BONUSES!**



# POW POW PANDA™

**BOOST  
BONUS**

**RISING  
BONUS**



**Discover your  
potential for explosive  
wins as the panda  
lights firecrackers!**





Also available in other Cabinets



**REEL CONFIGURATION**

5-Reel 3-Row Video Slot  
5-Reel 5-Row Video Slot (During RISING BONUS FEATURE and BOOST & RISING BONUS FEATURE )

**PAYLINES**

20 Lines (Bet Level 1)  
30 Lines (Bet Level 2)  
40 Lines (Bet Level 3)  
(During RISING BONUS FEATURE and BOOST & RISING BONUS FEATURE add 10 Lines)

**DENOMINATIONS**

1	2	3	4
1c	2c	5c	10c
2c	5c	10c	20c
5c	10c	20c	50c
10c	20c	50c	\$1
20c	50c	\$1	\$2
50c	\$1	\$2	\$5
\$1	\$2	\$5	\$10

**BET CONFIGURATIONS**

1, 2, 3, 4, 5, 6, 7, 8, 9, 10

**MIN/MAX BET & Cost to Cover**

MIN BET	MAX BET	Cost to Cover	BET LEVEL
38	380	38	Bet Level 1
58	580	58	Bet Level 2
88	880	88	Bet Level 3

(Depends on the above Bet Configurations)



**FREE GAMES FEATURE**

When WILD symbol appears on the center position of reel 3, there's a chance that FREE GAMES FEATURE will be triggered.

Before FREE GAME FEATURE start, firecracker will explode at the upper part of reels and award the following FREE GAMES FEATURE: BOOST BONUS, RISING BONUS, and BOOST & RISING BONUS

**BOOST BONUS FEATURE**



If the red firecracker explode, it triggers 6 FREE GAMES of BOOST BONUS FEATURE. Before BOOST BONUS FEATURE start, the state of the firecracker on the upper left side of the reels is reset.

During free games of BOOST BONUS FEATURE, the WILD symbol is always hold on the center position of reel 3. Different reels are used during BOOST BONUS FEATURE.

If you trigger both free games of BOOST BONUS FEATURE and RISING BONUS FEATURE in the same game, free games of BOOST & RISING BONUS FEATURE will start after free games of BOOST BONUS FEATURE end.

If you trigger free games of RISING BONUS FEATURE in the same game, it will start after free games of BOOST BONUS FEATURE end. If you win free games of BOOST BONUS FEATURE in the same game, an additional 6 free games added.

**RISING BONUS FEATURE**



If the purple firecracker explode, it triggers 6 FREE GAMES of RISING BONUS FEATURE. Before RISING BONUS FEATURE start, the state of the firecracker on the upper right side of the reels is reset.

At the start of RISING BONUS FEATURE, it would be 5 reels by 5 rows.

During RISING BONUS FEATURE, it will be 50 lines. During free games of RISING BONUS FEATURE, the WILD symbol is always hold on the center position of reel 3. Different reels are used during RISING BONUS FEATURE.

If you trigger both free games of BOOST BONUS FEATURE and RISING BONUS FEATURE in the same game, free games of BOOST & RISING BONUS FEATURE will start after free games of RISING BONUS FEATURE end.

If you win free games of RISING BONUS FEATURE in the same game, an additional 6 free games added. If you trigger free games of BOOST BONUS FEATURE in the same game, it will start after free games of RISING BONUS FEATURE end.

**BOOST & RISING BONUS FEATURE**



If the red and purple firecracker explode together, it triggers 12 FREE GAMES of BOOST & RISING BONUS FEATURE.

Before BOOST & RISING BONUS FEATURE start, the state of the firecracker on the upper left and right side of the reels is reset.

At the start of BOOST & RISING BONUS FEATURE, it would be 5 reels by 5 rows.

During BOOST & RISING BONUS FEATURE, it will be 50 lines.

During free games of BOOST & RISING BONUS FEATURE, the WILD symbol is always hold on the center position of reel 3. Different reels are used during BOOST & RISING BONUS FEATURE.

If you win free games of BOOST & RISING BONUS FEATURE in the same game, an additional 12 free games added. If you trigger free games of RISING BONUS FEATURE in the same game, it will start after free games of BOOST & RISING BONUS FEATURE end. If you trigger free games of BOOST BONUS FEATURE in the same game, it will start after free games of BOOST & RISING BONUS FEATURE end.





Also available in other Cabinets



**REEL CONFIGURATION**

5-Reel 3-Row Video Slot  
5-Reel 5-Row Video Slot (During RISING BONUS FEATURE and BOOST & RISING BONUS FEATURE )

**PAYLINES**

20 Lines (Bet Level 1)  
30 Lines (Bet Level 2)  
40 Lines (Bet Level 3)  
(During RISING BONUS FEATURE and BOOST & RISING BONUS FEATURE add 10 Lines)

**DENOMINATIONS**

1	2	3	4
1c	2c	5c	10c
2c	5c	10c	20c
5c	10c	20c	50c
10c	20c	50c	\$1
20c	50c	\$1	\$2
50c	\$1	\$2	\$5
\$1	\$2	\$5	\$10

**BET CONFIGURATIONS**

1, 2, 3, 4, 5, 6, 7, 8, 9, 10

**MIN/MAX BET & Cost to Cover**

MIN BET	MAX BET	Cost to Cover	BET LEVEL
38	380	38	Bet Level 1
58	580	58	Bet Level 2
88	880	88	Bet Level 3

(Depends on the above Bet Configurations)



**FREE GAMES FEATURE**

When WILD symbol appears on the center position of reel 3, there's a chance that FREE GAMES FEATURE will be triggered.

Before FREE GAME FEATURE start, firecracker will explode at the upper part of reels and award the following FREE GAMES FEATURE: BOOST BONUS, RISING BONUS, and BOOST & RISING BONUS

**BOOST BONUS FEATURE**



If the red firecracker explode, it triggers 6 FREE GAMES of BOOST BONUS FEATURE. Before BOOST BONUS FEATURE start, the state of the firecracker on the upper left side of the reels is reset.

During free games of BOOST BONUS FEATURE, the WILD symbol is always hold on the center position of reel 3. Different reels are used during BOOST BONUS FEATURE.

If you trigger both free games of BOOST BONUS FEATURE and RISING BONUS FEATURE in the same game, free games of BOOST & RISING BONUS FEATURE will start after free games of BOOST BONUS FEATURE end.

If you trigger free games of RISING BONUS FEATURE in the same game, it will start after free games of BOOST BONUS FEATURE end. If you win free games of BOOST BONUS FEATURE in the same game, an additional 6 free games added.

**RISING BONUS FEATURE**



If the purple firecracker explode, it triggers 6 FREE GAMES of RISING BONUS FEATURE. Before RISING BONUS FEATURE start, the state of the firecracker on the upper right side of the reels is reset.

At the start of RISING BONUS FEATURE, it would be 5 reels by 5 rows.

During RISING BONUS FEATURE, it will be 50 lines. During free games of RISING BONUS FEATURE, the WILD symbol is always hold on the center position of reel 3. Different reels are used during RISING BONUS FEATURE.

If you trigger both free games of BOOST BONUS FEATURE and RISING BONUS FEATURE in the same game, free games of BOOST & RISING BONUS FEATURE will start after free games of RISING BONUS FEATURE end.

If you win free games of RISING BONUS FEATURE in the same game, an additional 6 free games added. If you trigger free games of BOOST BONUS FEATURE in the same game, it will start after free games of RISING BONUS FEATURE end.

**BOOST & RISING BONUS FEATURE**



If the red and purple firecracker explode together, it triggers 12 FREE GAMES of BOOST & RISING BONUS FEATURE.

Before BOOST & RISING BONUS FEATURE start, the state of the firecracker on the upper left and right side of the reels is reset.

At the start of BOOST & RISING BONUS FEATURE, it would be 5 reels by 5 rows. During BOOST & RISING BONUS FEATURE, it will be 50 lines.

During free games of BOOST & RISING BONUS FEATURE, the WILD symbol is always hold on the center position of reel 3. Different reels are used during BOOST & RISING BONUS FEATURE.

If you win free games of BOOST & RISING BONUS FEATURE in the same game, an additional 12 free games added. If you trigger free games of RISING BONUS FEATURE in the same game, it will start after free games of BOOST & RISING BONUS FEATURE end. If you trigger free games of BOOST BONUS FEATURE in the same game, it will start after free games of BOOST & RISING BONUS FEATURE end.





New honeycomb LED (Details)



An LCD monitor with three 32-inch high definition monitor



New Face Design



**MUSO™**  
TRIPLE-32HD

Being the only one of its kind; unlike anything else.

A stunning new honeycomb cabinet LED display to attract players.

Thoughtful touches to keep them comfortable.

All designed for an unparalleled gaming experience.

### Stunning HD Graphics

Breathtakingly clear and bursting with rich colors displayed on three large **32-inch monitors**.

# BUILT FOR EXCELLENCE

### DIMENSION

**Upright Height (Tower Light Included)**  
2365 mm (93.1 in)

**Upright Height (Tower Light Excluded)**  
2271 mm (89.4 in)

**Width**  
810 mm (31.9 in)

**Depth**  
685.4 mm (27 in)



Please contact your Account Executive for more details.

sales@aruzeglobal.com

+1 702-781-8080

www.aruzeglobal.com

Follow us @AruzeGaming   



Empire Technological Group Ltd dba  
Aruze Gaming Global



# FORTUNE FRAME™



Boost your game  
play with random  
frames for a chance  
at the jackpot!





Also available in other Cabinet



**TYPE OF PRODUCT**

LINK / SAP

**REEL CONFIGURATION**

5-Reel 3-Row Video Slot

**PAYLINES**

243 Ways

**DENOMINATIONS**

1	2	3	4	5	6
1c	2c	5c	10c	\$1	\$2
2c	5c	10c	20c	50c	\$1
5c	10c	20c	50c	\$1	\$2
5c	10c	20c	50c	\$1	\$10
10c	20c	50c	\$1	\$2	\$5
20c	50c	\$1	\$2	\$5	\$10
50c	\$1	\$2	\$5	\$10	\$20
\$1	\$2	\$5	\$10	\$20	\$50
\$2	\$5	\$10	\$20	\$100	\$200
\$10	\$20	\$50	\$100	\$500	\$1000

**BET CONFIGURATIONS**

- 1, 2, 3, 4, 5
- 1, 2, 3, 4, 6
- 1, 2, 3, 5, 10
- 1, 2, 3, 6, 10
- 1, 2, 5, 10, 20

**MIN/MAX BET & Cost to Cover**

MIN BET	MAX BET	Cost to Cover
8	160	8
18	360	18
38	760	38
68	1360	68
88	1760	88

(Depends on the above Bet Configurations)



**CASH SPIN**



Any 6 or more in a bought game trigger the CASH SPIN FEATURE.

When the CASH SPIN FEATURE is triggered, 5 free spins are awarded.

All appearing in the game that triggers the CASH SPIN FEATURE become that are held in position on the reels for the duration of the CASH SPIN FEATURE.

There is a chance in each free spin that 1 is added to a random symbol position that does not already contain a held and is held in position until the CASH SPIN FEATURE ends.

Each spin, any prize appearing within a is won.

CASH SPIN FEATURE starts after the FREE GAMES FEATURE ends if triggered in the same bought game.

CASH SPIN FEATURE ends after all awarded free spins have been played.

All are removed when the CASH SPIN FEATURE ends.

**FREE GAMES**



Any 3 appearing on reels 2, 3 and 4 trigger the FREE GAMES FEATURE with 7 free games.

In each free game, there is a chance that one or more symbol positions randomly become or .

The sum of multipliers from every / / / that substitutes in a win multiplies the pay for that win.

Any appearing in the same position as / / / / is valid and displayed alternately if part of scatter win.

During the FREE GAMES FEATURE, any 3 appearing on reels 2, 3 and 4 awards 5 additional free games.

**JACKPOT SURPRISE**



There is a chance that 1 of the following prizes is randomly won in bought games except when FREE GAMES FEATURE or CASH SPIN FEATURE is triggered.

- GRAND JACKPOT
- MAJOR JACKPOT





Also available in other Cabinet



**TYPE OF PRODUCT**

LINK / SAP

**REEL CONFIGURATION**

5-Reel 3-Row Video Slot

**PAYLINES**

243 Ways

**DENOMINATIONS**

1	2	3	4	5	6
1c	2c	5c	10c	\$1	\$2
2c	5c	10c	20c	50c	\$1
5c	10c	20c	50c	\$1	\$2
5c	10c	20c	50c	\$1	\$10
10c	20c	50c	\$1	\$2	\$5
20c	50c	\$1	\$2	\$5	\$10
50c	\$1	\$2	\$5	\$10	\$20
\$1	\$2	\$5	\$10	\$20	\$50
\$2	\$5	\$10	\$20	\$100	\$200
\$10	\$20	\$50	\$100	\$500	\$1000

**BET CONFIGURATIONS**

- 1, 2, 3, 4, 5
- 1, 2, 3, 4, 6
- 1, 2, 3, 5, 10
- 1, 2, 3, 6, 10
- 1, 2, 5, 10, 20

**MIN/MAX BET & Cost to Cover**

MIN BET	MAX BET	Cost to Cover
8	160	8
18	360	18
38	760	38
68	1360	68
88	1760	88

(Depends on the above Bet Configurations)



**CASH SPIN**



Any 6 or more in a bought game trigger the CASH SPIN FEATURE.

When the CASH SPIN FEATURE is triggered, 5 free spins are awarded.

All appearing in the game that triggers the CASH SPIN FEATURE become that are held in position on the reels for the duration of the CASH SPIN FEATURE.

There is a chance in each free spin that 1 is added to a random symbol position that does not already contain a held and is held in position until the CASH SPIN FEATURE ends.

Each spin, any prize appearing within a is won.

CASH SPIN FEATURE starts after the FREE GAMES FEATURE ends if triggered in the same bought game.

CASH SPIN FEATURE ends after all awarded free spins have been played.

All are removed when the CASH SPIN FEATURE ends.

**FREE GAMES**



Any 3 appearing on reels 2, 3 and 4 trigger the FREE GAMES FEATURE with 7 free games.

In each free game, there is a chance that one or more symbol positions randomly become .

Any appearing in the same position as is valid and displayed alternately if part of scatter win.

During the FREE GAMES FEATURE, any 3 appearing on reels 2, 3 and 4 awards 5 additional free games.

**JACKPOT SURPRISE**



There is a chance that 1 of the following prizes is randomly won in bought games except when FREE GAMES FEATURE or CASH SPIN FEATURE is triggered.

- GRAND JACKPOT
- MAJOR JACKPOT



# DANCING PANDA SUPREME



**Wild surprises  
and fusion features  
bring happy blessings!**





Also available in other Cabinet



**TYPE OF PRODUCT**

LINK / SAP

**REEL CONFIGURATION**

5-Reel 3-Row Video Slot

**PAYLINES**

10, 20, 25, 30, 50 Lines (Denomination 1, 2)  
5, 10, 15, 20, 25 Lines (Denomination 3, 4, 5)  
1, 2, 3, 4, 5 Lines (Denomination 6, 7)

**DENOMINATIONS**

1	2	3	4	5	6	7
1c	2c	5c	10c	20c	\$1	\$2
5c	10c	25c	50c	\$1	\$5	\$10
10c	20c	50c	\$1	\$2	\$10	\$20
50c	\$1	\$2.50	\$5	\$10	\$50	\$100
\$1	\$2	\$5	\$10	\$20	\$100	\$200

**BET CONFIGURATIONS**

1, 2, 3, 4, 5  
1, 2, 3, 5, 8  
1, 2, 3, 5, 10  
1, 2, 5, 10, 20

**MIN/MAX BET & Cost to Cover**

MIN BET	MAX BET	Cost to Cover	Denomination
10	1000	10	Denomination 1, 2
5	500	5	Denomination 3, 4, 5
1	100	1	Denomination 6, 7

(Depends on the above Bet Configurations)



**FREE GAMES FEATURE**



Any 3 or more trigger the FREE GAMES. FREE GAMES consist of 8 FREE GAMES.

During FREE GAMES, any 3 or more award 5 additional free games.

FREE GAMES start after the FUSION FEATURE ends if triggered in the same game. If the FUSION FEATURE is triggered during the FREE GAMES, any remaining free games resume after the FUSION FEATURE ends.

**RANDOM WILD**

There is a chance RANDOM WILD is triggered during the FREE GAMES only.

In the game that RANDOM WILD occurs, one or more symbol positions randomly become a substitute symbol as described in the sequence below.

- : If randomly appears in a symbol position.
- : If randomly appears in a symbol position that already randomly became .

If randomly appears in the same symbol position as a on a reel strip, only the randomly appearing is valid.

Every substituting in a win multiplies the pay for that win. Any scatter appearing in the same position as / is valid and displayed alternately if part of scatter win. In the spin that RANDOM WILD occurs, all wins are determined after all randomly selected symbol positions have become their determined symbol on stopped reels.

**FUSION FEATURE**



Any 6 or more in a bought game or a FREE GAME trigger the FUSION FEATURE.

When the FUSION FEATURE is triggered, 3 free spins are awarded.

Any appearing in the game that triggers the FUSION FEATURE become in the FUSION FEATURE.

Any symbol position or FUSION FEATURE REEL PATTERN during the FUSION FEATURE are held in position on the reels for the duration of the FUSION FEATURE.

During the FUSION FEATURE free spins, each symbol position or FUSION FEATURE REEL PATTERN formed becomes an individual bonus reel. Any newly appearing in the FUSION FEATURE resets the number of remaining free spins to 3. FUSION FEATURE ends after all awarded free spins have been played or if all symbol positions are filled with / / .

**JACKPOT SURPRISE**



There is a chance that GRAND JACKPOT is randomly won in any bought game, except in the game that FUSION FEATURE is triggered.





Also available in other Cabinet



**TYPE OF PRODUCT**

LINK / SAP

**REEL CONFIGURATION**

5-Reel 3-Row Video Slot

**PAYLINES**

10, 20, 25, 30, 50 Lines (Denomination 1, 2)  
5, 10, 15, 20, 25 Lines (Denomination 3, 4, 5)  
1, 2, 3, 4, 5 Lines (Denomination 6, 7)

**DENOMINATIONS**

1	2	3	4	5	6	7
1c	2c	5c	10c	20c	\$1	\$2
5c	10c	25c	50c	\$1	\$5	\$10
10c	20c	50c	\$1	\$2	\$10	\$20
50c	\$1	\$2.50	\$5	\$10	\$50	\$100
\$1	\$2	\$5	\$10	\$20	\$100	\$200

**BET CONFIGURATIONS**

1, 2, 3, 4, 5  
1, 2, 3, 5, 8  
1, 2, 3, 5, 10  
1, 2, 5, 10, 20

**MIN/MAX BET & Cost to Cover**

MIN BET	MAX BET	Cost to Cover	Denomination
10	1000	10	Denomination 1, 2
5	500	5	Denomination 3, 4, 5
1	100	1	Denomination 6, 7

(Depends on the above Bet Configurations)



**FREE GAMES FEATURE**



Any 3 or more trigger the FREE GAMES in bought games only. FREE GAMES consist of 7 FREE GAMES. During FREE GAMES, each awards 1, 2 or 3 additional free games, randomly. FREE GAMES cannot be triggered again during the FREE GAMES. FREE GAMES start after the FUSION FEATURE ends if triggered in the same game. If the FUSION FEATURE is triggered during the FREE GAMES, any remaining free games resume after the FUSION FEATURE ends.

**RANDOM WILD**

There is a chance RANDOM WILD is triggered during the FREE GAMES only. In the game that RANDOM WILD occurs, one or more symbol positions randomly become a substitute symbol as described in the sequence below.

- : If randomly appears in a symbol position.
- : If randomly appears in a symbol position that already randomly became .

If randomly appears in the same symbol position as a on a reel strip, only the randomly appearing is valid. Every substituting in a win multiplies the pay for that win. Any scatter appearing in the same position as / is valid and displayed alternately if part of scatter win. RANDOM WILD and CHANGE UP cannot be triggered in the same free game. In the spin that RANDOM WILD occurs, all wins are determined after all randomly selected symbol positions have become their determined symbol on stopped reels.

**CHANGE UP**

There is a chance CHANGE UP is triggered during the FREE GAMES only. In the spin that CHANGE UP occurs, all on the reels change to 1 of the following symbols: or . CHANGE UP and RANDOM WILD cannot be triggered in the same free game. In the spin that CHANGE UP occurs, all wins are determined after all symbols have changed to their determined symbol on stopped reels.

**FUSION FEATURE**



Any 6 or more in a bought game or a FREE GAME trigger the FUSION FEATURE. When the FUSION FEATURE is triggered, 3 free spins are awarded. Any appearing in the game that triggers the FUSION FEATURE become in the FUSION FEATURE. Any symbol position or FUSION FEATURE REEL PATTERN during the FUSION FEATURE are held in position on the reels for the duration of the FUSION FEATURE. During the FUSION FEATURE free spins, each symbol position or FUSION FEATURE REEL PATTERN formed becomes an individual bonus reel. Any newly appearing in the FUSION FEATURE resets the number of remaining free spins to 3. FUSION FEATURE ends after all awarded free spins have been played or if all symbol positions are filled with / / .

**JACKPOT SURPRISE**



There is a chance that GRAND JACKPOT is randomly won in any bought game, except in the game that FUSION FEATURE is triggered.



# TOMB TREASURE™







Also available in other Cabinet



**TYPE OF PRODUCT**

[LINK](#) / [SAP](#)

**REEL CONFIGURATION**

5-Reel 3-Row Video Slot

**PAYLINES**

10, 25, 50 Lines (Denomination 1, 2)  
5, 10, 25 Lines (Denomination 3, 4, 5)  
5 Lines (Denomination 6, 7, 8)

**DENOMINATIONS**

1	2	3	4	5	6	7	8
1c	2c	5c	10c	20c	\$1	\$2	\$5
5c	10c	25c	50c	\$1	\$5	\$10	\$25
10c	20c	50c	\$1	\$2	\$10	\$20	\$50
50c	\$1	\$2.50	\$5	\$10	\$50	\$100	\$250
\$1	\$2	\$5	\$10	\$20	\$100	\$200	\$500

**BET CONFIGURATIONS**

1, 2, 3, 4, 5  
1, 2, 3, 5, 8  
1, 2, 3, 5, 10  
1, 2, 5, 10, 20

**MIN/MAX BET & Cost to Cover**

MIN BET	MAX BET	Cost to Cover	Denomination
10	1000	10	Denomination 1, 2
5	500	5	Denomination 3, 4, 5
5	100	5	Denomination 6, 7, 8

(Depends on the above Bet Configurations)



**FREE GAMES FEATURE**



Any 3 appearing on reels 2, 3 and 4 trigger the FREE GAMES FEATURE with 8 free games.

Reels used during the FREE GAMES FEATURE contain a greater total number of .

FREE GAMES FEATURE can be triggered again during the FREE GAMES FEATURE.

FREE GAMES FEATURE starts after the PYRAMID FEATURE ends if triggered in the same game.

If PYRAMID FEATURE is triggered during the FREE GAMES FEATURE, any remaining free games resume after the PYRAMID FEATURE ends.

**PYRAMID FEATURE**



Any 6 or more trigger the PYRAMID FEATURE and are held in position on the reels for the duration of the PYRAMID FEATURE.

PYRAMID FEATURE consists of 3 free spins.

During the PYRAMID FEATURE, each symbol position becomes an individual spinning bonus reel.

In the PYRAMID FEATURE, a prize map corresponding to the 15 symbol positions on the reels is displayed above the reels.

Before the first free spin, each on the reels displays the prize from the corresponding location on the prize map.

While a is held on the reels, the prize in the corresponding location on the prize map is also held.

At the start of each free spin in PYRAMID FEATURE, displayed prizes are redetermined for prize map squares that do not contain a held prize.

Each new appearing in a free spin displays a prize value that it is the sum of all held prizes displayed on the prize map from the previous free spin within the same PYRAMID FEATURE only.

Each new appearing in a free spin resets the number of remaining free spins to 3 and is held in position for the duration of the PYRAMID FEATURE.

PYRAMID FEATURE ends after all awarded free spins have been played or if appear in all 15 symbol positions. All prizes on Pyramid symbols are won at the end of feature.

**JACKPOT SURPRISE**



There is a chance that the GRAND JACKPOT is randomly won in bought games except when FREE GAMES FEATURE or PYRAMID FEATURE is triggered.





Also available in other Cabinet



**TYPE OF PRODUCT**

[LINK](#) / [SAP](#)

**REEL CONFIGURATION**

5-Reel 3-Row Video Slot

**PAYLINES**

10, 25, 50 Lines (Denomination 1, 2)  
5, 10, 25 Lines (Denomination 3, 4, 5)  
5 Lines (Denomination 6, 7, 8)

**DENOMINATIONS**

1	2	3	4	5	6	7	8
1c	2c	5c	10c	20c	\$1	\$2	\$5
5c	10c	25c	50c	\$1	\$5	\$10	\$25
10c	20c	50c	\$1	\$2	\$10	\$20	\$50
50c	\$1	\$2.50	\$5	\$10	\$50	\$100	\$250
\$1	\$2	\$5	\$10	\$20	\$100	\$200	\$500

**BET CONFIGURATIONS**

1, 2, 3, 4, 5  
1, 2, 3, 5, 8  
1, 2, 3, 5, 10  
1, 2, 5, 10, 20

**MIN/MAX BET & Cost to Cover**

MIN BET	MAX BET	Cost to Cover	Denomination
10	1000	10	Denomination 1, 2
5	500	5	Denomination 3, 4, 5
5	100	5	Denomination 6, 7, 8

(Depends on the above Bet Configurations)



**FREE GAMES FEATURE**



Any 3 appearing on reels 2, 3 and 4 trigger the FREE GAMES FEATURE with 6 free games.

Reels used during the FREE GAMES FEATURE contain a greater total number of .

FREE GAMES FEATURE can be triggered again during the FREE GAMES FEATURE.

FREE GAMES FEATURE starts after the PYRAMID FEATURE ends if triggered in the same game.

If PYRAMID FEATURE is triggered during the FREE GAMES FEATURE, any remaining free games resume after the PYRAMID FEATURE ends.

**PYRAMID FEATURE**



Any 6 or more trigger the PYRAMID FEATURE and are held in position on the reels for the duration of the PYRAMID FEATURE.

PYRAMID FEATURE consists of 3 free spins.

During the PYRAMID FEATURE, each symbol position becomes an individual spinning bonus reel.

In the PYRAMID FEATURE, a prize map corresponding to the 15 symbol positions on the reels is displayed above the reels.

Before the first free spin, each on the reels displays the prize from the corresponding location on the prize map.

While a is held on the reels, the prize in the corresponding location on the prize map is also held.

At the start of each free spin in PYRAMID FEATURE, displayed prizes are redetermined for prize map squares that do not contain a held prize.

Each new appearing in a free spin displays a prize value that is the sum of all held prizes displayed on the prize map from the previous free spin within the same PYRAMID FEATURE only.

Each new appearing in a free spin resets the number of remaining free spins to 3 and is held in position for the duration of the PYRAMID FEATURE.

PYRAMID FEATURE ends after all awarded free spins have been played or if appear in all 15 symbol positions. All prizes on Pyramid symbols are won at the end of feature.

**JACKPOT SURPRISE**



There is a chance that the GRAND JACKPOT is randomly won in bought games except when FREE GAMES FEATURE or PYRAMID FEATURE is triggered.





Also available in other Cabinet



**TYPE OF PRODUCT**

[LINK](#) / [SAP](#)

**REEL CONFIGURATION**

5-Reel 3-Row Video Slot

**PAYLINES**

10, 25, 50 Lines (Denomination 1, 2)  
5, 10, 25 Lines (Denomination 3, 4, 5)  
5 Lines (Denomination 6, 7, 8)

**DENOMINATIONS**

1	2	3	4	5	6	7	8
1c	2c	5c	10c	20c	\$1	\$2	\$5
5c	10c	25c	50c	\$1	\$5	\$10	\$25
10c	20c	50c	\$1	\$2	\$10	\$20	\$50
50c	\$1	\$2.50	\$5	\$10	\$50	\$100	\$250
\$1	\$2	\$5	\$10	\$20	\$100	\$200	\$500

**BET CONFIGURATIONS**

1, 2, 3, 4, 5  
1, 2, 3, 5, 8  
1, 2, 3, 5, 10  
1, 2, 5, 10, 20

**MIN/MAX BET & Cost to Cover**

MIN BET	MAX BET	Cost to Cover	Denomination
10	1000	10	Denomination 1, 2
5	500	5	Denomination 3, 4, 5
5	100	5	Denomination 6, 7, 8

(Depends on the above Bet Configurations)



**FREE GAMES FEATURE**



Any 3 appearing on reels 2, 3 and 4 trigger the FREE GAMES FEATURE with 8 free games.

Reels used during the FREE GAMES FEATURE contain a greater total number of .

FREE GAMES FEATURE can be triggered again during the FREE GAMES FEATURE.

FREE GAMES FEATURE starts after the PYRAMID FEATURE ends if triggered in the same game.

If PYRAMID FEATURE is triggered during the FREE GAMES FEATURE, any remaining free games resume after the PYRAMID FEATURE ends.

**PYRAMID FEATURE**



Any 6 or more trigger the PYRAMID FEATURE and are held in position on the reels for the duration of the PYRAMID FEATURE.

PYRAMID FEATURE consists of 3 free spins.

During the PYRAMID FEATURE, each symbol position becomes an individual spinning bonus reel.

In the PYRAMID FEATURE, a prize map corresponding to the 15 symbol positions on the reels is displayed above the reels.

Before the first free spin, each on the reels displays the prize from the corresponding location on the prize map.

While a is held on the reels, the prize in the corresponding location on the prize map is also held.

At the start of each free spin in PYRAMID FEATURE, displayed prizes are redetermined for prize map squares that do not contain a held prize.

Each new appearing in a free spin displays a prize value that is the sum of all held prizes displayed on the prize map from the previous free spin within the same PYRAMID FEATURE only.

Each new appearing in a free spin resets the number of remaining free spins to 3 and is held in position for the duration of the PYRAMID FEATURE.

PYRAMID FEATURE ends after all awarded free spins have been played or if appear in all 15 symbol positions. All prizes on Pyramid symbols are won at the end of feature.

**JACKPOT SURPRISE**



There is a chance that the GRAND JACKPOT is randomly won in bought games except when FREE GAMES FEATURE or PYRAMID FEATURE is triggered.



# LIGHTNING ARROW™



Unleash the  
arrow feature to  
collect rewards!





Also available in other Cabinet



**TYPE OF PRODUCT**

[LINK](#) / [SAP](#)

**REEL CONFIGURATION**

5-Reel 3-Row Video Slot

**PAYLINES**

40, 60, 80 Lines (Denomination 1c, 2c)  
25, 40 Lines (Denomination 5c, 10c, 20c)  
10 Lines (Denomination 100c, 200c)

**DENOMINATIONS**

1	2	3	4	5	6	7
1c	2c	5c	10c	20c	\$1	\$2
5c	10c	25c	50c	\$1	\$5	\$10
10c	20c	50c	\$1	\$2	\$10	\$20
50c	\$1	\$2.50	\$5	\$10	\$50	\$100
\$1	\$2	\$5	\$10	\$20	\$100	\$200

**BET CONFIGURATIONS**

1, 2  
1, 2, 3, 4, 5  
1, 2, 3, 5, 8  
1, 2, 3, 5, 10  
1, 2, 5, 10, 20 (Bet 20 Disabled for 200c)

**MIN/MAX BET & Cost to Cover**

MIN BET	MAX BET	Cost to Cover	Denomination
40	1600	40	Denomination 1, 2
25	500	25	Denomination 3, 4, 5
10	200	10	Denomination 6
10	100	10	Denomination 7

(Depends on the above Bet Configurations)



**FREE GAMES**



Credits bet and lines played during the FREE GAMES FEATURE are the same as the game that triggered the FREE GAMES FEATURE.

Any 3 or more trigger the FREE GAMES FEATURE with 9 free games. Different reels are used during the FREE GAMES FEATURE. Reels used during the FREE GAMES contain a greater total number of . FREE GAMES FEATURE can be triggered again during the FREE GAMES FEATURE. FREE GAMES FEATURE starts after the ARROW FEATURE ends if triggered in the same game. If ARROW FEATURE is triggered during the FREE GAMES FEATURE, any remaining free games resume after the ARROW FEATURE ends.

**ARROW FEATURE**



During the ARROW FEATURE, reel 3 becomes a PRIZE REEL containing the following available prizes on PRIZE SYMBOLS.

- PRIZE AMOUNT: equal to the total credits bet multiplied by 3, 4, 5, 6, 7, 8, 9, 15 randomly as displayed.
- PRIZE AMOUNT added to : equal to 24, 36, 40, 48, 56, 60, 80, 84, 112, 120, 160, 180, 200, 240, 300, and 400 credits multiplied by bet multiplier.
- BONUS: MINI BONUS, MINOR BONUS or MAJOR BONUS
- JACKPOT: MEGA JACKPOT or GRAND JACKPOT

On the PRIZE REEL on reel 3 in the ARROW FEATURE, only a PRIZE SYMBOL that fully appears within the on reel 3 is awarded.

- If a PRIZE AMOUNT or BONUS PRIZE SYMBOL displaying a is awarded, the value of the prize is added to the value of the prize on each held on reels 1 and 2.
- If a PRIZE AMOUNT or BONUS PRIZE SYMBOL displaying a is awarded, the value of the prize is added to the value of the prize on each held on reels 4 and 5.
- If a PRIZE AMOUNT or BONUS PRIZE SYMBOL displaying both and is awarded, the value of the prize is added to the value of the prize on each held on reels 1, 2, 4 and 5.
- If a PRIZE AMOUNT or BONUS PRIZE SYMBOL without an arrow is awarded, the displayed prize is won and added to the win meter.
- If a JACKPOT PRIZE SYMBOL is awarded, the displayed JACKPOT is won and added to the credit meter.

Any newly appearing in the ARROW FEATURE resets the number of remaining free spins to 3 and is held in position until the ARROW FEATURE ends.

Any PRIZE SYMBOL that fully appears within the on reel 3 resets the number of remaining free spins to 3. Once ceiling is reached contributions are carried over to the next progressive.

ARROW FEATURE ends after all awarded free spins have been played. ARROW FEATURE prizes are added to any line wins occurring in the game that triggers the ARROW FEATURE. Credit Prize values on PRIZE SYMBOLS and on are displayed in currency if their individual value equals 100,000 credits or more. Credits bet during the ARROW FEATURE are the same as the game that triggered the ARROW FEATURE.





Also available in other Cabinet



**TYPE OF PRODUCT**

**LINK / SAP**

**REEL CONFIGURATION**

5-Reel 3-Row Video Slot

**PAYLINES**

40, 60, 80 Lines (Denomination 1c, 2c)  
25, 40 Lines (Denomination 5c, 10c, 20c)  
10 Lines (Denomination 100c, 200c)

**DENOMINATIONS**

1	2	3	4	5	6	7
1c	2c	5c	10c	20c	\$1	\$2
5c	10c	25c	50c	\$1	\$5	\$10
10c	20c	50c	\$1	\$2	\$10	\$20
50c	\$1	\$2.50	\$5	\$10	\$50	\$100
\$1	\$2	\$5	\$10	\$20	\$100	\$200

**BET CONFIGURATIONS**

1, 2  
1, 2, 3, 4, 5  
1, 2, 3, 5, 8  
1, 2, 3, 5, 10  
1, 2, 5, 10, 20 (Bet 20 Disabled for 200c)

**MIN/MAX BET & Cost to Cover**

MIN BET	MAX BET	Cost to Cover	Denomination
40	1600	40	Denomination 1, 2
25	500	25	Denomination 3, 4, 5
10	200	10	Denomination 6
10	100	10	Denomination 7

(Depends on the above Bet Configurations)



**FREE GAMES**



Any 3 or more trigger the FREE GAMES FEATURE with 9 free games. Different reels are used during the FREE GAMES FEATURE. Reels used during the FREE GAMES contain a greater total number of . FREE GAMES FEATURE can be triggered again during the FREE GAMES FEATURE. FREE GAMES FEATURE starts after the ARROW FEATURE ends if triggered in the same game. If ARROW FEATURE is triggered during the FREE GAMES FEATURE, any remaining free games resume after the ARROW FEATURE ends.

Credits bet and lines played during the FREE GAMES FEATURE are the same as the game that triggered the FREE GAMES FEATURE.

**ARROW FEATURE**



Any 6 or more in a bought game or during the FREE GAMES FEATURE trigger the ARROW FEATURE and are held for the duration of the ARROW FEATURE. When the ARROW FEATURE is triggered, 3 free spins are awarded. Different reels are used during the ARROW FEATURE. Each symbol position on reels 1, 2, 4 and 5 becomes an individual spinning bonus reel during the ARROW FEATURE.

During the ARROW FEATURE, reel 3 becomes a PRIZE REEL containing the following available prizes on PRIZE SYMBOLS.

- PRIZE AMOUNT: equal to the total credits bet multiplied by 3, 4, 5, 6, 7, 8, 9, 15 randomly as displayed.
- PRIZE AMOUNT added to : equal to 24, 36, 40, 48, 56, 60, 80, 84, 112, 120, 160, 180, 200, 240, 300, and 400 credits multiplied by bet multiplier.
- BONUS: MINI BONUS, MINOR BONUS or MAJOR BONUS
- JACKPOT: MEGA JACKPOT or GRAND JACKPOT

On the PRIZE REEL on reel 3 in the ARROW FEATURE, only a PRIZE SYMBOL that fully appears within the on reel 3 is awarded.

- If a PRIZE AMOUNT or BONUS PRIZE SYMBOL displaying a is awarded, the value of the prize is added to the value of the prize on each held on reels 1 and 2.
- If a PRIZE AMOUNT or BONUS PRIZE SYMBOL displaying a is awarded, the value of the prize is added to the value of the prize on each held on reels 4 and 5.
- If a PRIZE AMOUNT or BONUS PRIZE SYMBOL displaying both and is awarded, the value of the prize is added to the value of the prize on each held on reels 1, 2, 4 and 5.
- If a PRIZE AMOUNT or BONUS PRIZE SYMBOL without an arrow is awarded, the displayed prize is won and added to the win meter.
- If a JACKPOT PRIZE SYMBOL is awarded, the displayed JACKPOT is won and added to the credit meter.

Any newly appearing in the ARROW FEATURE resets the number of remaining free spins to 3 and is held in position until the ARROW FEATURE ends.

Any PRIZE SYMBOL that fully appears within the on reel 3 resets the number of remaining free spins to 3. Once ceiling is reached contributions are carried over to the next progressive.

ARROW FEATURE ends after all awarded free spins have been played. ARROW FEATURE prizes are added to any line wins occurring in the game that triggers the ARROW FEATURE. Credit Prize values on PRIZE SYMBOLS and on are displayed in currency if their individual value equals 100,000 credits or more. Credits bet during the ARROW FEATURE are the same as the game that triggered the ARROW FEATURE.



# QIAN DUO DUO



Collect the dragon  
coins to maximize  
your wealth!





Also available in other Cabinet



**TYPE OF PRODUCT**

[LINK](#) / [SAP](#)

**REEL CONFIGURATION**

5-Reel 3-Row Video Slot

**PAYLINES**

243 Ways

**DENOMINATIONS**

1	2	3	4	5	6
1c	2c	5c	10c	\$1	\$2
2c	5c	10c	20c	50c	\$1
5c	10c	20c	50c	\$1	\$2
5c	10c	20c	50c	\$1	\$10
10c	20c	50c	\$1	\$2	\$5
20c	50c	\$1	\$2	\$5	\$10
50c	\$1	\$2	\$5	\$10	\$20
\$1	\$2	\$5	\$10	\$20	\$50
\$2	\$5	\$10	\$20	\$100	\$200
\$10	\$20	\$50	\$100	\$500	\$1,000

**BET CONFIGURATIONS**

1, 2, 3, 4, 5, 6, 7, 8, 9, 10

**MIN/MAX BET & Cost to Cover**

MIN BET	MAX BET	Cost to Cover	BET LEVEL
18	180	18	Bet Level 1
28	280	28	Bet Level 2
38	380	38	Bet Level 3
68	680	68	Bet Level 4
88	880	88	Bet Level 5

(Depends on the above Bet Configurations)



**COIN SPIN FEATURE**



3 scattered appearing on reels 2, 3 and 4 trigger the COIN SPIN FEATURE.

When the COIN SPIN FEATURE is triggered, 3 free spins are awarded.

Each newly appearing displaying "+1 SPIN" in a free spin awards 1 additional free spin.

COIN SPIN FEATURE ends after all awarded free spins have been played.

Credits bet during the COIN SPIN FEATURE are the same as the game that triggered the COIN SPIN FEATURE.

**JACKPOT FEATURE**



There is a chance that the JACKPOT FEATURE may be triggered when 1 or more appears in bought games only.

In the JACKPOT FEATURE, select from 12 icons until 3 matching symbols corresponding to a JACKPOT level are revealed.

When 3 matching JACKPOT level symbols have been revealed, the corresponding JACKPOT level is won and the JACKPOT FEATURE ends.

SYMBOLS	JACKPOTS
	GRAND
	MAJOR
	MINOR
	MINI

The chances of revealing each jackpot symbol are not equal.

SYMBOLS	JACKPOTS
BET 88	GRAND, MAJOR, MINOR, MINI
BET 68	GRAND, MAJOR, MINOR, MINI
BET 38	MAJOR, MINOR, MINI
BET 28	MAJOR, MINOR, MINI
BET 18	MAJOR, MINOR, MINI

A JACKPOT level is reset to its initial value each time that JACKPOT level is won.

JACKPOT FEATURE and COIN SPIN FEATURE cannot be triggered in the same game.





Also available in other Cabinet



**TYPE OF PRODUCT**

[LINK](#) / [SAP](#)

**REEL CONFIGURATION**

5-Reel 3-Row Video Slot

**PAYLINES**

243 Ways

**DENOMINATIONS**

1	2	3	4	5	6
1c	2c	5c	10c	\$1	\$2
2c	5c	10c	20c	50c	\$1
5c	10c	20c	50c	\$1	\$2
5c	10c	20c	50c	\$1	\$10
10c	20c	50c	\$1	\$2	\$5
20c	50c	\$1	\$2	\$5	\$10
50c	\$1	\$2	\$5	\$10	\$20
\$1	\$2	\$5	\$10	\$20	\$50
\$2	\$5	\$10	\$20	\$100	\$200
\$10	\$20	\$50	\$100	\$500	\$1,000

**BET CONFIGURATIONS**

1, 2, 3, 4, 5, 6, 7, 8, 9, 10

**MIN/MAX BET & Cost to Cover**

MIN BET	MAX BET	Cost to Cover	BET LEVEL
18	180	18	Bet Level 1
28	280	28	Bet Level 2
38	380	38	Bet Level 3
68	680	68	Bet Level 4
88	880	88	Bet Level 5

(Depends on the above Bet Configurations)



**COIN SPIN FEATURE**



3 scattered appearing on reels 2, 3 and 4 trigger the COIN SPIN FEATURE.

When the COIN SPIN FEATURE is triggered, 3 free spins are awarded.

Each newly appearing displaying "+1 SPIN" in a free spin awards 1 additional free spin.

COIN SPIN FEATURE ends after all awarded free spins have been played.

Credits bet during the COIN SPIN FEATURE are the same as the game that triggered the COIN SPIN FEATURE.

**JACKPOT FEATURE**



There is a chance that the JACKPOT FEATURE may be triggered when 1 or more appears in bought games only.

In the JACKPOT FEATURE, select from 12 icons until 3 matching symbols corresponding to a JACKPOT level are revealed.

When 3 matching JACKPOT level symbols have been revealed, the corresponding JACKPOT level is won and the JACKPOT FEATURE ends.

SYMBOLS	JACKPOTS
	GRAND
	MAJOR
	MINOR
	MINI

The chances of revealing each jackpot symbol are not equal.

SYMBOLS	JACKPOTS
BET 88	GRAND, MAJOR, MINOR, MINI
BET 68	GRAND, MAJOR, MINOR, MINI
BET 38	MAJOR, MINOR, MINI
BET 28	MAJOR, MINOR, MINI
BET 18	MAJOR, MINOR, MINI

A JACKPOT level is reset to its initial value each time that JACKPOT level is won.

JACKPOT FEATURE and COIN SPIN FEATURE cannot be triggered in the same game.



# HAPPY LION™







Also available in other Cabinet



**TYPE OF PRODUCT**

[LINK](#) / [SAP](#)

**REEL CONFIGURATION**

5-Reel 3-Row Video Slot

**PAYLINES**

50 Lines (Denomination 1, 2, 3, 4, 5, 6)  
25 Lines (Denomination 1, 2, 3, 4, 5, 6, 7)  
5 Lines (Denomination 6, 7)

**DENOMINATIONS**

1	2	3	4	5	6	7
1c	2c	5c	10c	20c	\$1	\$2
5c	10c	25c	50c	\$1	\$5	\$10
10c	20c	50c	\$1	\$2	\$10	\$20
50c	\$1	\$2.50	\$5	\$10	\$50	\$100
\$1	\$2	\$5	\$10	\$20	\$100	\$200

**BET CONFIGURATIONS**

1, 2, 3, 4, 5, 6, 8, 10

**MIN/MAX BET & Cost to Cover**

MIN BET	MAX BET	Cost to Cover	Denomination
25	500	25	Denomination 1, 2, 3, 4, 5
5	500	5	Denomination 6
5	250	5	Denomination 7

(Depends on the above Bet Configurations)



**FREE GAMES**



Any 3 or more trigger the FREE GAMES. FREE GAMES consist of 8 FREE GAMES.

FREE GAMES can be triggered again during the FREE GAMES.

FREE GAMES start after the COLLECT FEATURE ends if triggered in the same game.

If the COLLECT FEATURE is triggered during the FREE GAMES, any remaining free games resume after the COLLECT FEATURE ends.

Credits bet and lines played during the FREE GAMES are the same as the game that triggered the FREE GAMES.

**COLLECT FEATURE**



1 appearing in a bought game or FREE GAME triggers the COLLECT FEATURE and is held for the duration of the COLLECT FEATURE.

Any appearing in the same bought game or FREE GAME with are also held for the duration of the COLLECT FEATURE.

When the COLLECT FEATURE is triggered, 3 free spins are awarded.

Each new appearing in a free spin resets the number of remaining free spins to 3 and is held in position for the duration of the COLLECT FEATURE.

COLLECT FEATURE ends after all awarded free spins have been played or if / appear in all 15 symbol positions.

Credits bet during the COLLECT FEATURE are the same as the game that triggered the COLLECT FEATURE or the FREE GAMES.

**MYSTERY PRIZE**



There is a chance that 1 of the following prizes is randomly won in any bought game, except in the game that COLLECT FEATURE is triggered.

- MAJOR JACKPOT
- GRAND JACKPOT





Also available in other Cabinet



**TYPE OF PRODUCT**

[LINK](#) / [SAP](#)

**REEL CONFIGURATION**

5-Reel 3-Row Video Slot

**PAYLINES**

50 Lines (Denomination 1, 2, 3, 4, 5, 6)  
25 Lines (Denomination 1, 2, 3, 4, 5, 6, 7)  
5 Lines (Denomination 6, 7)

**DENOMINATIONS**

1	2	3	4	5	6	7
1c	2c	5c	10c	20c	\$1	\$2
5c	10c	25c	50c	\$1	\$5	\$10
10c	20c	50c	\$1	\$2	\$10	\$20
50c	\$1	\$2.50	\$5	\$10	\$50	\$100
\$1	\$2	\$5	\$10	\$20	\$100	\$200

**BET CONFIGURATIONS**

1, 2, 3, 4, 5, 6, 8, 10

**MIN/MAX BET & Cost to Cover**

MIN BET	MAX BET	Cost to Cover	Denomination
25	500	25	Denomination 1, 2, 3, 4, 5
5	500	5	Denomination 6
5	250	5	Denomination 7

(Depends on the above Bet Configurations)



**FREE GAMES**



Any 3 or more trigger the FREE GAMES. FREE GAMES consist of 8 FREE GAMES.

FREE GAMES can be triggered again during the FREE GAMES.

FREE GAMES start after the COLLECT FEATURE ends if triggered in the same game.

If the COLLECT FEATURE is triggered during the FREE GAMES, any remaining free games resume after the COLLECT FEATURE ends.

Credits bet and lines played during the FREE GAMES are the same as the game that triggered the FREE GAMES.

**COLLECT FEATURE**



1 appearing in a bought game or FREE GAME triggers the COLLECT FEATURE and is held for the duration of the COLLECT FEATURE.

Any appearing in the same bought game or FREE GAME with are also held for the duration of the COLLECT FEATURE.

When the COLLECT FEATURE is triggered, 3 free spins are awarded.

Each new appearing in a free spin resets the number of remaining free spins to 3 and is held in position for the duration of the COLLECT FEATURE.

COLLECT FEATURE ends after all awarded free spins have been played or if / appear in all 15 symbol positions.

Credits bet during the COLLECT FEATURE are the same as the game that triggered the COLLECT FEATURE or the FREE GAMES.

**MYSTERY PRIZE**



There is a chance that 1 of the following prizes is randomly won in any bought game, except in the game that COLLECT FEATURE is triggered.

- MAJOR JACKPOT
- GRAND JACKPOT





Also available in other Cabinet



**TYPE OF PRODUCT**

[LINK](#) / [SAP](#)

**REEL CONFIGURATION**

5-Reel 3-Row Video Slot

**PAYLINES**

50 Lines (Denomination 1, 2, 3, 4, 5, 6)  
25 Lines (Denomination 1, 2, 3, 4, 5, 6, 7)  
5 Lines (Denomination 6, 7)

**DENOMINATIONS**

1	2	3	4	5	6	7
1c	2c	5c	10c	20c	\$1	\$2
5c	10c	25c	50c	\$1	\$5	\$10
10c	20c	50c	\$1	\$2	\$10	\$20
50c	\$1	\$2.50	\$5	\$10	\$50	\$100
\$1	\$2	\$5	\$10	\$20	\$100	\$200

**BET CONFIGURATIONS**

1, 2, 3, 4, 5, 6, 8, 10

**MIN/MAX BET & Cost to Cover**

MIN BET	MAX BET	Cost to Cover	Denomination
25	500	25	Denomination 1, 2, 3, 4, 5
5	500	5	Denomination 6
5	250	5	Denomination 7

(Depends on the above Bet Configurations)

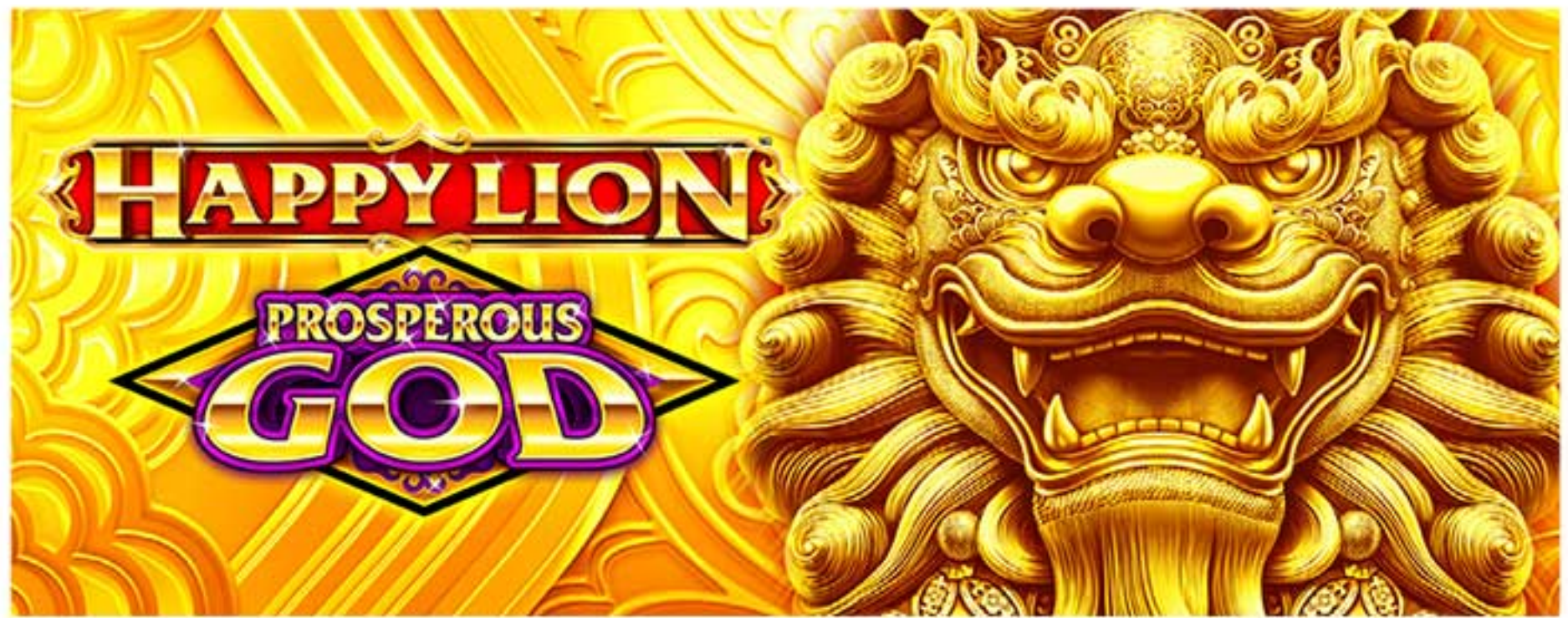

**FREE GAMES**



Any 3 or more trigger the FREE GAMES. FREE GAMES consist of 8 FREE GAMES. Extra added on the reels remain until the FREE GAMES end. FREE GAMES can be triggered again one time only during the FREE GAMES. 3 extra are added on each reels 2,3,4, and 9 extra are added on reel 5 starting from free game 2 until the end of free game 8. If the feature is re-triggered, there will be no extra added to the reels in the re-triggered feature after free game 8.

FREE GAMES start after the COLLECT FEATURE ends if triggered in the same game.

If the COLLECT FEATURE is triggered during the FREE GAMES, any remaining free games resume after the COLLECT FEATURE ends.

Credits bet and lines played during the FREE GAMES are the same as the game that triggered the FREE GAMES.

**COLLECT FEATURE**



1 appearing in a bought game or FREE GAME triggers the COLLECT FEATURE and is held for the duration of the COLLECT FEATURE.

Any appearing in the same bought game or FREE GAME with are also held for the duration of the COLLECT FEATURE.

When the COLLECT FEATURE is triggered, 3 free spins are awarded.

Each new appearing in a free spin resets the number of remaining free spins to 3 and is held in position for the duration of the COLLECT FEATURE.

COLLECT FEATURE ends after all awarded free spins have been played or if / appear in all 15 symbol positions.

Credits bet during the COLLECT FEATURE are the same as the game that triggered the COLLECT FEATURE or the FREE GAMES.

**MYSTERY PRIZE**



There is a chance that 1 of the following prizes is randomly won in any bought game, except in the game that COLLECT FEATURE is triggered.

- MAJOR JACKPOT
- GRAND JACKPOT



# Fortune Key™



Unlock the  
door to many  
fortunes!





Also available in other Cabinet



**TYPE OF PRODUCT**

[LINK](#) / [SAP](#)

**REEL CONFIGURATION**

5-Reel 3-Row Video Slot

**PAYLINES**

50 Lines

**DENOMINATIONS**

1	2	3	4	5	6	7
1c	2c	5c	10c	20c	\$1	\$2
5c	10c	25c	50c	\$1	\$5	\$10
10c	20c	50c	\$1	\$2	\$10	\$20
50c	\$1	\$2.50	\$5	\$10	\$50	\$100
\$1	\$2	\$5	\$10	\$20	\$100	\$200

**BET CONFIGURATIONS**

- 1, 2, 3, 4, 5
- 1, 2, 3, 5, 8
- 1, 2, 3, 5, 10
- 1, 2, 5, 10, 20

**MIN/MAX BET & Cost to Cover**

MIN BET	MAX BET	Cost to Cover
75	1500	75

(Depends on the above Bet Configurations)



**FREE GAMES FEATURE**



Any 3 or more scattered in a bought game trigger FREE GAMES FEATURE.

FREE GAMES FEATURE consist of 10 free spin.

Different reels are use during the FREE GAMES FEATURE.

FREE GAMES FEATURE can be triggered again during the FREE GAMES FEATURE awarding 10 more free spins.

FREE GAMES FEATURE starts after the FIRST EMPEROR FEATURE ends if triggered in the same game.

If FIRST EMPEROR FEATURE is triggered during the FREE GAMES FEATURE, any remaining free games resume after the FIRST EMPEROR FEATURE ends.

**FIRST EMPEROR FEATURE**



FIRST EMPEROR FEATURE is triggered when WILD appears in reel 1, reel 2 and at least one in reel 3, reel 4 and reel 5.

FIRST EMPEROR FEATURE consist of 5 spins.

Any appears will be held in position on the reels for the duration of FIRST EMPEROR FEATURE.

During the FIRST EMPEROR FEATURE, each symbol position becomes an individual spinning bonus reel.

Before FIRST EMPEROR FEATURE start, reel 1 and reel 2 is locked.

Each new appearing in the reels during the FIRST EMPEROR FEATURE adds 1 spin and is held in position for the duration of the FIRST EMPEROR FEATURE.

When appear in all 9 symbol positions, reel 2 will be unlocked.

Reel 2 spun once for that game only and may award one of the following prizes.

- PRIZE AMOUNT: each equal to 1, 2, 3, 4, 5, 6, 7, 8, 10, 12, 15 or 20 credits multiplied by total bet as displayed.



When is triggered inside reel 2, reel 1 will be unlocked.

After reel 1 unlocked, one of the following prizes will be awarded.

- MULTIPLIER: x2, x3 or x5
- BONUS: MINI X2 BONUS, MINOR BONUS, MINOR x2 BONUS.
- JACKPOT: GRAND JACKPOT or MAJOR JACKPOT

Reel 2 prizes will change to greater value and may award one of the following prizes.

- PRIZE AMOUNT: each equal to 10, 12, 15 or 20 credits multiplied by total bet as displayed.
- BONUS: MINI BONUS

Reel 1 will spun once for that game only and reel 2 spun once again.

FIRST EMPEROR FEATURE ends after all awarded free spins have been played.





Also available in other Cabinet



**TYPE OF PRODUCT**

[LINK](#) / [SAP](#)

**REEL CONFIGURATION**

5-Reel 3-Row Video Slot

**PAYLINES**

50 Lines

**DENOMINATIONS**

1	2	3	4	5	6	7
1c	2c	5c	10c	20c	\$1	\$2
5c	10c	25c	50c	\$1	\$5	\$10
10c	20c	50c	\$1	\$2	\$10	\$20
50c	\$1	\$2.50	\$5	\$10	\$50	\$100
\$1	\$2	\$5	\$10	\$20	\$100	\$200

**BET CONFIGURATIONS**

- 1, 2, 3, 4, 5
- 1, 2, 3, 5, 8
- 1, 2, 3, 5, 10
- 1, 2, 5, 10, 20

**MIN/MAX BET & Cost to Cover**

MIN BET	MAX BET	Cost to Cover
75	1500	75

(Depends on the above Bet Configurations)



**FREE GAMES FEATURE**



Any 3 or more scattered  in a bought game trigger FREE GAMES FEATURE.

FREE GAMES FEATURE consist of 10 free spin. Different reels are use during the FREE GAMES FEATURE.

Each spin a random Reel from Reels 3, 4, or 5 is selected to have BONUS Symbols only.

FREE GAMES FEATURE can be triggered again during the FREE GAMES FEATURE awarding 10 more free spins.

FREE GAMES FEATURE starts after the JADE EMPRESS FEATURE ends if triggered in the same game.

If JADE EMPRESS FEATURE is triggered during the FREE GAMES FEATURE, any remaining free games resume after the JADE EMPRESS FEATURE ends.

**JADE EMPRESS FEATURE**



JADE EMPRESS FEATURE is triggered when WILD appears in reel 1, reel 2 and at least one  in reel 3, reel 4 and reel 5.

JADE EMPRESS FEATURE consist of 5 spins.

Any  appears will be held in position on the reels for the duration of JADE EMPRESS FEATURE.

During the JADE EMPRESS FEATURE, each symbol position becomes an individual spinning bonus reel.

Before JADE EMPRESS FEATURE start, reel 1 and reel 2 is locked.

Each new  appearing in the reels during the JADE EMPRESS FEATURE adds 1 spin and is held in position for the duration of the JADE EMPRESS FEATURE.

When  appear in all 9 symbol positions, reel 2 will be unlocked.

Reel 2 spun once for that game only and may award one of the following prizes.

- PRIZE AMOUNT: each equal to 1, 2, 3, 4, 5, 6, 7, 8, 10, 12, 15 or 20 credits multiplied by total bet as displayed.

When  is triggered inside reel 2, reel 1 will be unlocked.

After reel 1 unlocked, one of the following prizes will be awarded.

- MULTIPLIER: x2, x3 or x5
- BONUS: MINI X2 BONUS, MINOR BONUS, MINOR x2 BONUS.
- JACKPOT: GRAND JACKPOT or MAJOR JACKPOT

Reel 2 prizes will change to greater value and may award one of the following prizes.

- PRIZE AMOUNT: each equal to 10, 12, 15 or 20 credits multiplied by total bet as displayed.
- BONUS: MINI BONUS

Reel 1 will spun once for that game only and reel 2 spun once again.

JADE EMPRESS FEATURE ends after all awarded free spins have been played.



# HYPER Speed

Entertainment has a classy new look.

Players can enjoy an exciting gaming experience.

Optimal service design for accessibility and maintenance.

### Stunning HD Graphics

An vertical LCD monitor with 43-inch LCD high definition monitor.

### Ergonomic button deck

Premium Speed 11.6-inch LCD Touch Screen panel with Bash Button.

### Immersive Audio

Newly designed sound system creates powerful theater-like sound.

### USB charging

USB charging port & wireless Charger also provided for player convenience.

## DIMENSION

(Without Base Stand)

### Upright Height

(Tower Light Included)  
2219.9 mm (87.40 in)

### Upright Height

(Tower Light Excluded)  
2116.9 mm (83.34 in)

### Width

680 mm (26.77 in)

### Depth

631.1 mm (24.85 in)

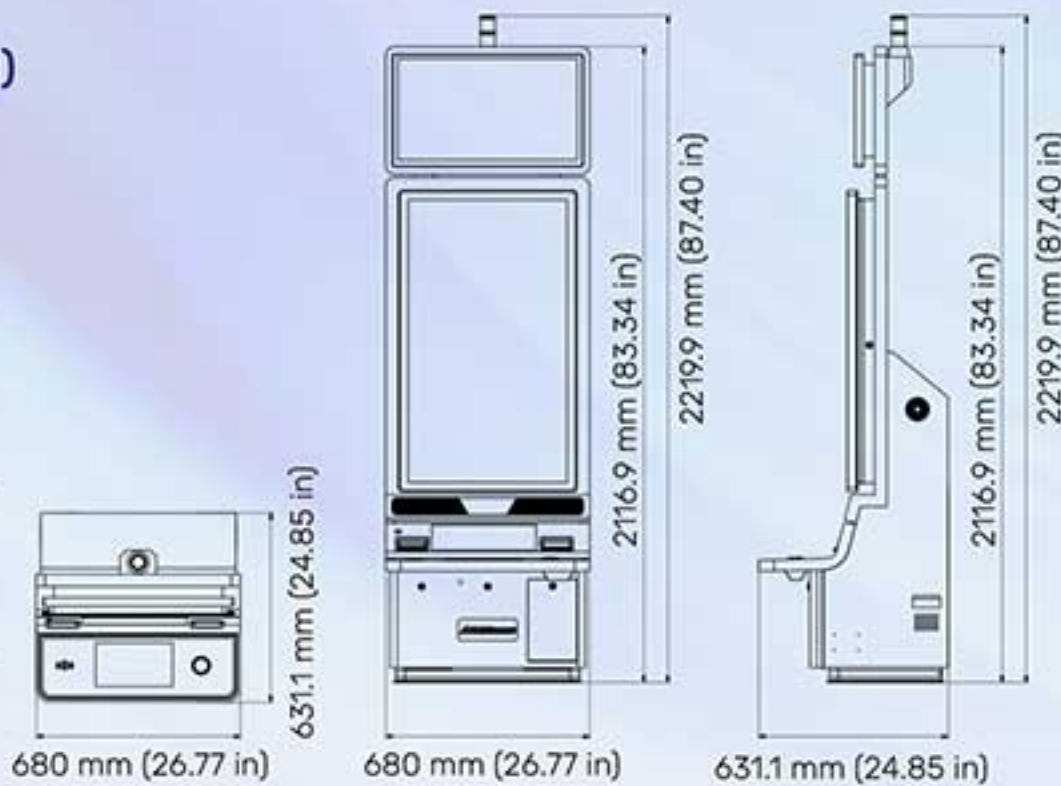

## DIMENSION

(With Custom Base Stand)

### Upright Height

(Tower Light Included)  
2677.1 mm (105.40 in)

### Upright Height

(Tower Light Excluded)  
2574.1 mm (101.34 in)

### Width

680 mm (26.77 in)

### Depth

631.1 mm (24.85 in)

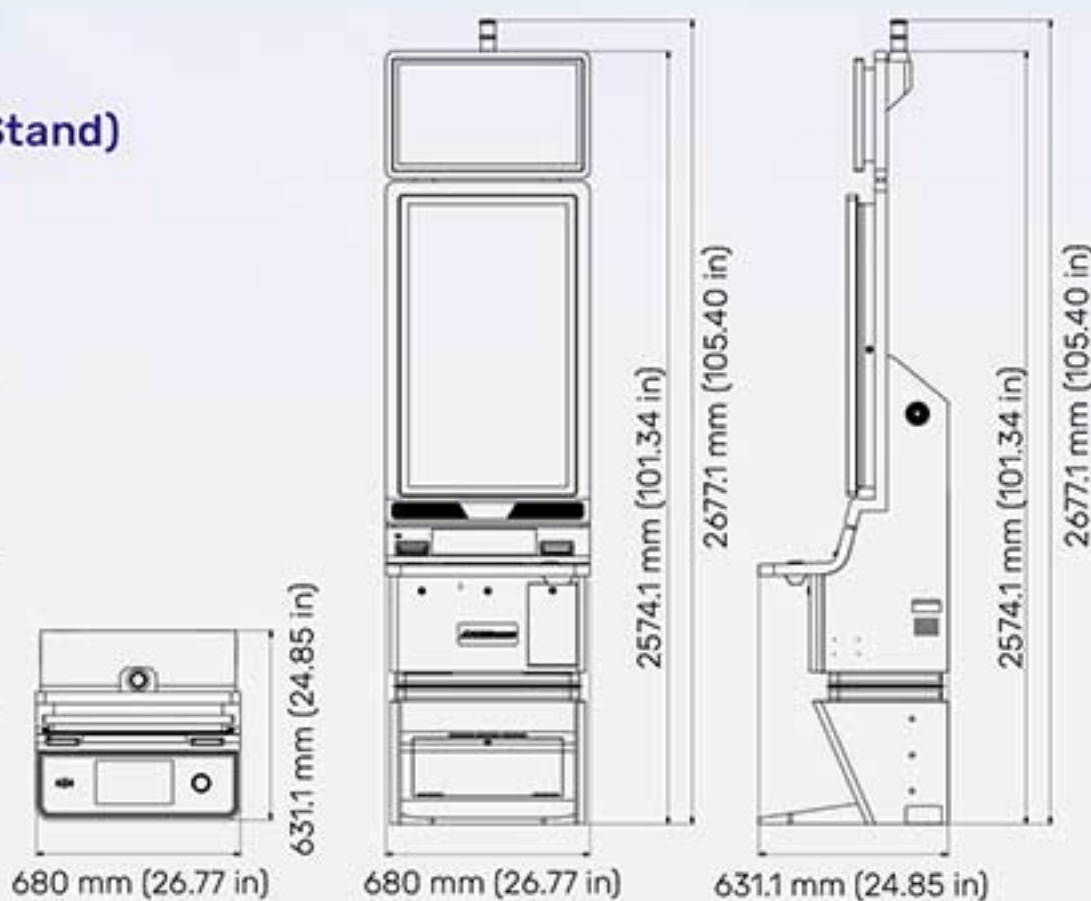

Please contact your Account Executive for more details.

sales@aruzeglobal.com

+1 702-781-8080

www.aruzeglobal.com

Follow us @AruzeGaming



Empire Technological Group Ltd dba  
Aruze Gaming Global



# GONG CASH™



**Fortunes abound  
with a cascade of  
gold coins in this  
thrilling theme!**





Also available in other Cabinet



**TYPE OF PRODUCT**

[LINK](#) / [SAP](#)

**REEL CONFIGURATION**

5-Reel 3-Row Video Slot

**PAYLINES**

243 Ways

**DENOMINATIONS**

1c

**BET CONFIGURATIONS**

1, 2, 3, 4, 5, 6, 7, 8, 9, 10

**MIN/MAX BET & Cost to Cover**

MIN BET	MAX BET	Cost to Cover
88	880	88

(Depends on the above Bet Configurations)



**GONG SPIN FEATURE**



3 scattered appearing on reels 2, 3 and 4 trigger the GONG SPIN FEATURE.

When the GONG SPIN FEATURE is triggered, 3 free spins are awarded.

Each newly appearing displaying "+1 SPIN" in a free spin awards 1 additional free spin.

GONG SPIN FEATURE ends after all awarded free spins have been played.

**JACKPOT FEATURE**



There is a chance that the JACKPOT FEATURE may be triggered when 1 or more appears in bought games only.

In the JACKPOT FEATURE, select from 12 icons until 3 matching symbols corresponding to a JACKPOT level are revealed.

When 3 matching JACKPOT level symbols have been revealed, the corresponding JACKPOT level is won and the JACKPOT FEATURE ends. The chances of revealing each jackpot symbol are not equal.

A JACKPOT level is reset to its initial value each time that JACKPOT level is won.

JACKPOT FEATURE and GONG SPIN FEATURE cannot be triggered in the same game.





Also available in other Cabinet



**TYPE OF PRODUCT**

[LINK](#) / [SAP](#)

**REEL CONFIGURATION**

5-Reel 3-Row Video Slot

**PAYLINES**

243 Ways

**DENOMINATIONS**

1c

**BET CONFIGURATIONS**

1, 2, 3, 4, 5, 6, 7, 8, 9, 10

**MIN/MAX BET & Cost to Cover**

MIN BET	MAX BET	Cost to Cover
88	880	88

(Depends on the above Bet Configurations)



**GONG SPIN FEATURE**



3 scattered appearing on reels 2, 3 and 4 trigger the GONG SPIN FEATURE.

When the GONG SPIN FEATURE is triggered, 3 free spins are awarded.

Each newly appearing displaying "+1 SPIN" in a free spin awards 1 additional free spin.

GONG SPIN FEATURE ends after all awarded free spins have been played.

**JACKPOT FEATURE**



There is a chance that the JACKPOT FEATURE may be triggered when 1 or more appears in bought games only.

In the JACKPOT FEATURE, select from 12 icons until 3 matching symbols corresponding to a JACKPOT level are revealed.

When 3 matching JACKPOT level symbols have been revealed, the corresponding JACKPOT level is won and the JACKPOT FEATURE ends. The chances of revealing each jackpot symbol are not equal.

A JACKPOT level is reset to its initial value each time that JACKPOT level is won.

JACKPOT FEATURE and GONG SPIN FEATURE cannot be triggered in the same game.



# FU JIN SHU™

# 赋金树

GRAND  
**\$8,800.00**  
- MAJOR -  
**\$800.00**  
MINOR \$25.01    MINI \$10.03

GRAND  
**\$8,800.74**  
- MAJOR -  
**\$801.11**  
MINOR \$26.48    MINI \$12.96



An abundance  
of coins on the  
great tree results in  
blossoming wins!





GRAND	\$8,800.00
MAJOR	\$800.00
MINOR	\$25.01
MINI	\$10.03



### TYPE OF PRODUCT

LINK / SAP

### REEL CONFIGURATION

5-Reel 3-4-4-4-3-Row Video Slot  
(EXPANDER REELS: Up to 7-8-8-8-7-Row)

### PAYLINES

32 Lines  
(EXPANDER REELS: Up to 80 Lines)

### DENOMINATIONS

1c

### BET CONFIGURATIONS

1, 2, 3, 4, 5, 6, 7, 8, 9, 10

### MIN/MAX BET & Cost to Cover

MIN BET	MAX BET	Cost to Cover
88	880	88

(Depends on the above Bet Configurations)



### EXPANDER REELS

During bought games, 2 scattered appearing on reels 2 and 3 trigger EXPANDER REELS. During free games, EXPANDER REELS are randomly triggered. In the spin that EXPANDER REELS are triggered, all reels are expanded upward 1, 2, 3 or 4 rows of symbols, randomly.



### FREE GAMES

3 scattered appearing on reels 1, 3 and 5 trigger 7 free games. Different reels are used during the free games.

### EXTRA WILD

If EXPANDER REELS are triggered in a free game, there is a chance that one or more symbol positions randomly become or for that game. All wins determined after the completion of symbol changes has occurred. The sum of multipliers from every that substitutes in a win multiplies the pay for that win. Free games start after the JACKPOT FEATURE ends if triggered in the same bought game.

### WILD HOLD SPINS

3 scattered appearing on reels 2, 3 and 4 trigger 6 free spins of overlaying reels containing while the reels of the bought game are held. All payable wins for the bought game are determined after the last free spin. When a stops on a symbol position, that symbol position becomes a substitute symbol as described below and is held in position until all wins for the bought game are determined after the last free spin. No wins for any combination during the free spins.



- : If stops on any symbol position.
- : If stops on a symbol position that became .
- : If stops on a symbol position that became .
- : If stops on a symbol position that became .
- : If stops on a symbol position that became .
- : If stops on a symbol position that became .

The sum of multipliers from every that substitutes in a win multiplies the pay for that win. The row height of the overlay reels used during the free spins are the same as the row height of the reels used in the game that triggered the free spins. WILD HOLD SPINS start after the JACKPOT FEATURE ends if triggered in the same bought game.



### JACKPOT FEATURE

There is a chance that the JACKPOT FEATURE may be triggered when 1 or more appear on reels 2, 3 or 4 in bought games only. on any reel in a bought game that is a result of WILD HOLD SPINS does not offer a chance to trigger the JACKPOT FEATURE. In the JACKPOT FEATURE, there are 4 types of jackpot symbols hidden behind 12 icons. Select an icon until 3 matching jackpot symbols corresponding to a JACKPOT are revealed. When 3 matching jackpot symbols have been revealed, the corresponding JACKPOT is won and the JACKPOT FEATURE ends. JACKPOT FEATURE and BONUS SURPRISE cannot be triggered in the same game.



### BONUS SURPRISE

There is a chance that the BONUS SURPRISE may be triggered when 1 or more appear on reels 2, 3 or 4 in bought games only. on any reel in a bought game that is a result of WILD HOLD SPINS does not offer a chance to trigger the BONUS SURPRISE. When the BONUS SURPRISE occurs, 10000 credits multiplied by bet multiplier as displayed are awarded. BONUS SURPRISE and JACKPOT FEATURE cannot be triggered in the same game. Any BONUS SURPRISE win is added to line wins.





**TYPE OF PRODUCT**

**LINK / SAP**

**REEL CONFIGURATION**

5-Reel 3-4-4-4-3-Row Video Slot  
(EXPANDER REELS: Up to 7-8-8-8-7-Row)

**PAYLINES**

32 Lines  
(EXPANDER REELS: Up to 80 Lines)

**DENOMINATIONS**

1c

**BET CONFIGURATIONS**

1, 2, 3, 4, 5, 6, 7, 8, 9, 10

**MIN/MAX BET & Cost to Cover**

MIN BET	MAX BET	Cost to Cover
88	880	88

(Depends on the above Bet Configurations)



**EXPANDER REELS**

During bought games, 2 scattered appearing on reels 2 and 3 trigger EXPANDER REELS. During free games, EXPANDER REELS are randomly triggered. In the spin that EXPANDER REELS are triggered, all reels are expanded upward 1, 2, 3 or 4 rows of symbols, randomly.



**FREE GAMES**

3 scattered appearing on reels 1, 3 and 5 trigger 7 free games. Different reels are used during the free games.

**REELS WILD**

If EXPANDER REELS are triggered in a free game, there is a chance that all symbol positions on 2 or 3 reels become either or in that game. All wins determined after the completion of symbol changes has occurred. The sum of multipliers from every that substitutes in a win multiplies the pay for that win. Free games start after the JACKPOT FEATURE ends if triggered in the same bought game.

**WILD HOLD SPINS**

3 scattered appearing on reels 2, 3 and 4 trigger 6 free spins of overlaying reels containing while the reels of the bought game are held. All payable wins for the bought game are determined after the last free spin. When a stops on a symbol position, that symbol position becomes a substitute symbol as described below and is held in position until all wins for the bought game are determined after the last free spin. No wins for any combination during the free spins.



**15 COLLECTED**

- : If stops on any symbol position.
- : If stops on a symbol position that became .
- : If stops on a symbol position that became .
- : If stops on a symbol position that became .
- : If stops on a symbol position that became .
- : If stops on a symbol position that became .

The sum of multipliers from every //// that substitutes in a win multiplies the pay for that win. The row height of the overlay reels used during the free spins are the same as the row height of the reels used in the game that triggered the free spins. WILD HOLD SPINS start after the JACKPOT FEATURE ends if triggered in the same bought game.



**JACKPOT FEATURE**

There is a chance that the JACKPOT FEATURE may be triggered when 1 or more appear on reels 2, 3 or 4 in bought games only. on any reel in a bought game that is a result of WILD HOLD SPINS does not offer a chance to trigger the JACKPOT FEATURE. In the JACKPOT FEATURE, there are 4 types of jackpot symbols hidden behind 12 icons. Select an icon until 3 matching jackpot symbols corresponding to a JACKPOT are revealed. When 3 matching jackpot symbols have been revealed, the corresponding JACKPOT is won and the JACKPOT FEATURE ends. JACKPOT FEATURE and BONUS SURPRISE cannot be triggered in the same game.



**BONUS SURPRISE**

There is a chance that the BONUS SURPRISE may be triggered when 1 or more appear on reels 2, 3 or 4 in bought games only. on any reel in a bought game that is a result of WILD HOLD SPINS does not offer a chance to trigger the BONUS SURPRISE. When the BONUS SURPRISE occurs, 10000 credits multiplied by bet multiplier as displayed are awarded. BONUS SURPRISE and JACKPOT FEATURE cannot be triggered in the same game. Any BONUS SURPRISE win is added to line wins.





CAI YUN LAI™

# 财运来







## FREE GAMES



appearing on 3 or more consecutive reels beginning with the leftmost reel trigger the free games. Different reels are used during the free games. Before free games start, select 1 of 3 free game options to play.



Every multiplier on substituting in a win multiplies the pay for that win.

During the free games, appearing on 2 or more consecutive reels beginning with the leftmost reel award 3 additional free games.

Free games start after the JACKPOT FEATURE ends if triggered in the same game.

If JACKPOT FEATURE is triggered during free games, any remaining free games resume after JACKPOT FEATURE ends. Credits bet, GOLD PAYS and ways played during the free games are the same as the game that triggered the free games.

## JACKPOT FEATURE

There is a chance that the JACKPOT FEATURE may be triggered when 1 or more appears.



In the JACKPOT FEATURE, select from 12 icons until 3 matching symbols corresponding to a JACKPOT level are revealed.

When 3 matching JACKPOT level symbols have been revealed, the corresponding JACKPOT level is won and the JACKPOT FEATURE ends.

JACKPOT levels available according to GOLD PAYS played. The chances of revealing each jackpot symbol are not equal.

JACKPOT FEATURE and BONUS SURPRISE cannot be triggered in the same game.

## TYPE OF PRODUCT

[LINK](#) / [SAP](#)

## REEL CONFIGURATION

5-Reel 3-4-4-4-3-Row Video Slot

## PAYLINES

576 Ways

## DENOMINATIONS

1c

## BET CONFIGURATIONS

1, 2, 3, 4, 5, 6, 7, 8, 9, 10

## MIN/MAX BET & Cost to Cover

MIN BET	MAX BET	Cost to Cover
88	880	88

(Depends on the above Bet Configurations)

## BONUS SURPRISE



There is a chance that the BONUS SURPRISE may be triggered when 1 or more appears.

When the BONUS SURPRISE occurs, 25000 credits are awarded.

BONUS SURPRISE and JACKPOT FEATURE cannot be triggered in the same game.

Any BONUS SURPRISE win is added to line wins.





### FREE GAMES



appearing on 3 or more consecutive reels beginning with the leftmost reel trigger the free games. Different reels are used during the free games. Before free games start, select 1 of 4 free game options to play.



During the free games, appearing on 2 or more consecutive reels beginning with the leftmost reel award 3 additional free games within the free game option being played.

Free games start after the JACKPOT FEATURE ends if triggered in the same game.

If JACKPOT FEATURE is triggered during free games, any remaining free games resume after JACKPOT FEATURE ends. Credits bet and GOLD PAYS played during the free games are the same as the game that triggered the free games.

### JACKPOT FEATURE

There is a chance that the JACKPOT FEATURE may be triggered when 1 or more appears.



In the JACKPOT FEATURE, select from 12 icons until 3 matching symbols corresponding to a JACKPOT level are revealed.

When 3 matching JACKPOT level symbols have been revealed, the corresponding JACKPOT level is won and the JACKPOT FEATURE ends.

JACKPOT levels available according to GOLD PAYS played. The chances of revealing each jackpot symbol are not equal.

JACKPOT FEATURE and BONUS SURPRISE cannot be triggered in the same game.

### TYPE OF PRODUCT

[LINK](#) / [SAP](#)

### REEL CONFIGURATION

5-Reel 3-4-4-4-3-Row Video Slot  
(Up to 6-7-7-7-6-Row during the free games)

### PAYLINES

576 Ways

### DENOMINATIONS

1c

### BET CONFIGURATIONS

1, 2, 3, 4, 5, 6, 7, 8, 9, 10

### MIN/MAX BET & Cost to Cover

MIN BET	MAX BET	Cost to Cover
88	880	88

(Depends on the above Bet Configurations)

### BONUS SURPRISE



There is a chance that the BONUS SURPRISE may be triggered when 1 or more appears.

When the BONUS SURPRISE occurs, 250000 credits are awarded.

BONUS SURPRISE and JACKPOT FEATURE cannot be triggered in the same game.

Any BONUS SURPRISE win is added to line wins.



# HYPER Speed



## FREE GAMES



☒ appearing on 3 or more consecutive reels beginning with the leftmost reel trigger 6 free games. Different reels are used during the free games. At the start of each free game, randomly determined symbol positions on 2 to 4 reels become for that free game only. The number of positions that can randomly become corresponds to the GOLD PAYS played, the number of reels that random appears on and the reel number as described below.

GOLD PAYS	RANDOM  APPEARING ON TWO REELS					RANDOM  APPEARING ON THREE REELS					RANDOM  APPEARING ON FOUR REELS				
	1	2	3	4	5	1	2	3	4	5	1	2	3	4	5
MAX GOLD PAYS	3	4	4	4	3	2	3	3	3	3	2	3	3	3	3
GOLD PAYS 4	3	4	4	4	3	2	3	3	3	3	2	3	3	3	3
GOLD PAYS 3	2	2	2	2	3	2	3	3	3	2	2	3	3	3	3
GOLD PAYS 2	2	2	2	2	3	2	3	3	3	2	2	3	3	3	3

All wins determined on stopped reels after the completion of all symbol changes.

Free games cannot be triggered again during the free games. Free games start after the JACKPOT FEATURE ends if triggered in the same bought game.

If JACKPOT FEATURE is triggered during free games, any remaining free games resume after JACKPOT FEATURE ends. Credits bet, GOLD PAYS and ways played during the free games are the same as the game that triggered the free games.

## JACKPOT FEATURE

There is a chance that the JACKPOT FEATURE may be triggered when 1 or more appears.



In the JACKPOT FEATURE, select from 12 icons until 3 matching symbols corresponding to a JACKPOT level are revealed.

When 3 matching JACKPOT level symbols have been revealed, the corresponding JACKPOT level is won and the JACKPOT FEATURE ends.

JACKPOT levels available according to GOLD PAYS played. The chances of revealing each jackpot symbol are not equal.

JACKPOT FEATURE and BONUS SURPRISE cannot be triggered in the same game.

## BONUS SURPRISE



There is a chance that the BONUS SURPRISE may be triggered when 1 or more appears.

When the BONUS SURPRISE occurs, 250,000 credits are awarded. BONUS SURPRISE and JACKPOT FEATURE cannot be triggered in the same game.

Any BONUS SURPRISE win is added to line wins.

## TYPE OF PRODUCT

[LINK](#) / [SAP](#)

## REEL CONFIGURATION

5-Reel 3-4-4-4-3-Row Video Slot

## PAYLINES

576 Ways

## DENOMINATIONS

1c

## BET CONFIGURATIONS

1, 2, 3, 4, 5, 6, 7, 8, 9, 10

## MIN/MAX BET & Cost to Cover

MIN BET	MAX BET	Cost to Cover
88	880	88

(Depends on the above Bet Configurations)



# FU RU YI 福如意



**Customize your  
game play for  
greater fortunes!**





### IMPROVED REELS

PLAY OPTIONS	
PLAY 88 REELS	Reels do not contain A, K, Q and J.
PLAY 78 REELS	Reels do not contain K, Q and J.
PLAY 58 REELS	Reels do not contain Q and J.
PLAY 38 REELS	Reels do not contain J.
PLAY 18 REELS	Reels contain all symbols.

Reels contains fewer lower-paying symbols



### FORTUNE BONUS

FORTUNE BONUS randomly occurs in bought games and free games.

### TYPE OF PRODUCT

[LINK](#) / [SAP](#)

### REEL CONFIGURATION

5-Reel 3-Row Video Slot

### PAYLINES

243 Ways

(FREE GAMES: 1024 or 3125 or 7776 WAYS)

### DENOMINATIONS

1c

### BET CONFIGURATIONS

1, 2, 3, 6, 10

### MIN/MAX BET & Cost to Cover

MIN BET	MAX BET	Cost to Cover	BET LEVEL
18	180	18	Bet Level 1
38	380	38	Bet Level 2
58	580	58	Bet Level 3
78	780	78	Bet Level 4
88	880	88	Bet Level 5

(Depends on the above Bet Configurations)



### FREE GAMES FEATURE

福 appearing on 3 or more consecutive reels beginning with the leftmost reel trigger the free games.

Select reel format and then reel type from the available free game options.

If 福 appears in the game that triggers the free games, the number of free games is increased for the free game options.

The number of free games awarded depends on the selection of reel format and the inclusion of 福, 猪 and 福 on the reels.



### JACKPOT FEATURE

There is a chance the JACKPOT FEATURE may be triggered when 1 or more 福 / 福 appear.

If 福 appears in the game that triggered the JACKPOT FEATURE, a total of 3 JACKPOT FEATURES are awarded and played one after the other.

Select an icon by touching it on the screen, or randomly select an icon by pressing the PLAY button.

When 3 matching symbols have been revealed, the corresponding PRIZE is won and the JACKPOT FEATURE ends.

The JACKPOT FEATURE awards the following:

- 3 JACKPOT LEVELS: GRAND, SUPER, MAJOR
- 2 BONUS PRIZES: MINOR and MINI

BONUS PRIZES INCREASED IN EXCESS OF BET MULTIPLIER

BET MULTIPLIER	BONUS PRIZES	
	MINOR	MINI
x10	\$1,000.00	\$200.00
x6	\$500.00	\$100.00
x3	\$200.00	\$40.00
x2	\$125.00	\$25.00
x1	\$50.00	\$10.00





**IMPROVED REELS**

PLAY OPTIONS

PLAY 88 CREDITS	Reels do not contain A, K, Q, and J.
PLAY 78 CREDITS	Reels do not contain K, Q, and J.
PLAY 58 CREDITS	Reels do not contain Q, and J.
PLAY 38 CREDITS	Reels do not contain J.
PLAY 18 CREDITS	Reels contain all symbols.

Reels contains fewer lower-paying symbols



**FORTUNE BONUS**  
FORTUNE BONUS randomly occurs in bought games and free games.



**FREE GAMES FEATURE**  
 🐷 appearing on 3 or more consecutive reels beginning with the leftmost reel trigger the free games.  
 Select reel format and then max multiplier from the available free game options.  
 If 🐷 appears in the game that triggers the free games, the number of free games is increased for the free game options.  
 If 🐷 appears in a free game, all 🎰 pays in that spin are multiplied by the multiplier displayed on 🐷.



**JACKPOT FEATURE**  
 There is a chance the JACKPOT FEATURE may be triggered when 1 or more 🐷 / 🐷 appear.  
 If 🐷 appears in the game that triggered the JACKPOT FEATURE, a total of 3 JACKPOT FEATURES are awarded and played one after the other.  
 Select an icon by touching it on the screen, or randomly select an icon by pressing the PLAY button.  
 When 3 matching symbols have been revealed, the corresponding PRIZE is won and the JACKPOT FEATURE ends.

**BONUS PRIZES**  
BONUS PRIZES INCREASED IN EXCESS OF BET MULTIPLIER

BET MULTIPLIER	MINOR	MINI
x10	\$1,000.00	\$200.00
x6	\$500.00	\$100.00
x3	\$200.00	\$40.00
x2	\$125.00	\$25.00
x1	\$50.00	\$10.00

The JACKPOT FEATURE awards the following:  
 • 3 JACKPOT LEVELS: GRAND, SUPER, MAJOR  
 • 2 BONUS PRIZES: MINOR and MINI  
 BONUS PRIZES INCREASED IN EXCESS OF BET MULTIPLIER

**TYPE OF PRODUCT**

[LINK](#) / [SAP](#)

**REEL CONFIGURATION**

5-Reel 3-Row Video Slot

**PAYLINES**

243 Ways  
 (FREE GAMES: 1024 or 3125 or 7776 WAYS)

**DENOMINATIONS**

1c

**BET CONFIGURATIONS**

1, 2, 3, 6, 10

**MIN/MAX BET & Cost to Cover**

MIN BET	MAX BET	Cost to Cover	BET LEVEL
18	180	18	Bet Level 1
38	380	38	Bet Level 2
58	580	58	Bet Level 3
78	780	78	Bet Level 4
88	880	88	Bet Level 5

(Depends on the above Bet Configurations)



# FIRESTORM™



**Special fireball  
symbols unlocking  
rows and awarding  
blazing prizes!**









Also available in other Cabinet



**TYPE OF PRODUCT**

[LINK](#) / [SAP](#)

**REEL CONFIGURATION**

5-Reel 4-Row Video Slot  
(Up to 10 rows during RISING FIRE)

**PAYLINES**

50 Lines

**DENOMINATIONS**

1	2	3	4	5
1c	2c	5c	10c	20c
5c	10c	25c	50c	\$1
10c	20c	50c	\$1	\$2
50c	\$1	\$2.50	\$5	\$10
\$1	\$2	\$5	\$10	\$20

**BET CONFIGURATIONS**

1, 2, 3, 4, 5, 8, 10

**MIN/MAX BET & Cost to Cover**

MIN BET	MAX BET	Cost to Cover
75	975	75

(Depends on the above Bet Configurations)



**FREE GAMES FEATURE**

appearing on 3 or more consecutive reels beginning with the leftmost reel trigger the FREE GAMES FEATURE. When the FREE GAMES FEATURE is triggered, a number appears on each that was involved in triggering the feature. 1, 2, 3, 5, 7 or 10 free games are awarded for each . The sum of the numbers that appeared is awarded as FREE GAMES in the FREE GAMES FEATURE. FREE GAMES FEATURE can be triggered again during the FREE GAMES FEATURE. FREE GAMES FEATURE starts after RISING FIRE ends if triggered in the same game. If RISING FIRE is triggered during the FREE GAMES FEATURE, any remaining free games resume after RISING FIRE ends.



**MYSTERY SYMBOL**

appearing on the reels changes to , , or . appearing in the same game randomly change to the same symbol. If appears, wins are determined after finishes changing. Does not appear during RISING FIRE.



**RISING FIRE**

Any 6 or more / in a bought game or free game trigger RISING FIRE. During RISING FIRE, all symbol positions become individual spinning bonus reels. Any that trigger RISING FIRE or appear during RISING FIRE are held for the duration of RISING FIRE. Any that trigger RISING FIRE or appear during RISING FIRE decrease the remaining number of needed to unlock bonus symbol rows and decrease the number of remaining needed to win the UP UP JACKPOT. When RISING FIRE is triggered, 3 free spins are awarded.

Each newly appearing / in a free spin resets the number of remaining free spins to 3.

RISING FIRE ends after all awarded free spins have been played or if fills every symbol position.

Any unlocked bonus symbol row is locked again after RISING FIRE ends.

The number of remaining required to unlock any bonus symbol row is reset after RISING FIRE ends.

The number of remaining required to win the UP UP JACKPOT is reset after RISING FIRE ends.



**JACKPOT SURPRISE RISING FIRE**

There is a chance that 1 JACKPOT is randomly won in bought games except when FREE GAMES FEATURE or RISING FIRE is triggered.



# GONG GONG LAIFU™



**The sound  
of the Gong brings  
good fortune!**



# HYPER Speed



Also available in other Cabinet



### TYPE OF PRODUCT

LINK / SAP

### REEL CONFIGURATION

5-Reel 3-Row Video Slot

### PAYLINES

10, 25, 50 Lines (Denomination 1, 2)  
5, 10, 25 Lines (Denomination 3, 4, 5)  
5 Lines (Denomination 6, 7, 8)

### DENOMINATIONS

1	2	3	4	5	6	7	8
1c	2c	5c	10c	20c	\$1	\$2	\$5
5c	10c	25c	50c	\$1	\$5	\$10	\$25
10c	20c	50c	\$1	\$2	\$10	\$20	\$50
50c	\$1	\$2.50	\$5	\$10	\$50	\$100	\$250
\$1	\$2	\$5	\$10	\$20	\$100	\$200	\$500

### BET CONFIGURATIONS

1, 2, 3, 4, 5  
1, 2, 3, 5, 8  
1, 2, 3, 5, 10  
1, 2, 5, 10, 20

### MIN/MAX BET & Cost to Cover

MIN BET	MAX BET	Cost to Cover	Denomination
10	1000	10	Denomination 1, 2
5	500	5	Denomination 3, 4, 5
5	100	5	Denomination 6, 7, 8

(Depends on the above Bet Configurations)



### FREE GAMES FEATURE



Any 3 appearing on reels 2, 3 and 4 trigger the FREE GAMES FEATURE with 8 free games.

Reels used during the FREE GAMES FEATURE contain a greater total number of .

FREE GAMES FEATURE can be triggered again during the FREE GAMES FEATURE.

FREE GAMES FEATURE starts after the GONG GONG LAI FU FEATURE ends if triggered in the same game.

If GONG GONG LAI FU FEATURE is triggered during the FREE GAMES FEATURE, any remaining free games resume after the GONG GONG LAI FU FEATURE ends.

### GONG GONG LAI FU FEATURE



Any 6 or more trigger the GONG GONG LAI FU FEATURE and are held in position on the reels for the duration of the GONG GONG LAI FU FEATURE.

GONG GONG LAI FU FEATURE consists of 3 free spins.

During the GONG GONG LAI FU FEATURE, each symbol position becomes an individual spinning bonus reel.

In the GONG GONG LAI FU FEATURE, a prize map corresponding to the 15 symbol positions on the reels is displayed above the reels. Before the first free spin, each on the reels displays the prize from the corresponding location on the prize map. While a is held on the reels, the prize in the corresponding location on the prize map is also held. At the start of each free spin in GONG GONG LAI FU FEATURE, displayed prizes are redetermined for prize map squares that do not contain a held prize.

Each new appearing in a free spin displays a prize value that it is the sum of all held prizes displayed on the prize map from the previous free spin within the same GONG GONG LAI FU FEATURE only.

Each new appearing in a free spin resets the number of remaining free spins to 3 and is held in position for the duration of the GONG GONG LAI FU FEATURE. GONG GONG LAI FU FEATURE ends after all awarded free spins have been played or if appear in all 15 symbol positions. All prizes on Gong symbols are won at the end of feature.

### JACKPOT SURPRISE



There is a chance that the GRAND JACKPOT is randomly won in bought games except when FREE GAMES FEATURE or GONG GONG LAI FU FEATURE is triggered.





Also available in other Cabinet



**TYPE OF PRODUCT**

LINK / SAP

**REEL CONFIGURATION**

5-Reel 3-Row Video Slot

**PAYLINES**

10, 25, 50 Lines (Denomination 1, 2)  
 5, 10, 25 Lines (Denomination 3, 4, 5)  
 5 Lines (Denomination 6, 7, 8)

**DENOMINATIONS**

1	2	3	4	5	6	7	8
1c	2c	5c	10c	20c	\$1	\$2	\$5
5c	10c	25c	50c	\$1	\$5	\$10	\$25
10c	20c	50c	\$1	\$2	\$10	\$20	\$50
50c	\$1	\$2.50	\$5	\$10	\$50	\$100	\$250
\$1	\$2	\$5	\$10	\$20	\$100	\$200	\$500

**BET CONFIGURATIONS**

1, 2, 3, 4, 5  
 1, 2, 3, 5, 8  
 1, 2, 3, 5, 10  
 1, 2, 5, 10, 20

**MIN/MAX BET & Cost to Cover**

MIN BET	MAX BET	Cost to Cover	Denomination
10	1000	10	Denomination 1, 2
5	500	5	Denomination 3, 4, 5
5	100	5	Denomination 6, 7, 8

(Depends on the above Bet Configurations)



**FREE GAMES FEATURE**



Any 3 Buddha appearing on reels 2, 3 and 4 trigger the FREE GAMES FEATURE with 6 free games.

Reels used during the FREE GAMES FEATURE contain a greater total number of Buddha.

FREE GAMES FEATURE can be triggered again during the FREE GAMES FEATURE.

FREE GAMES FEATURE starts after the GONG GONG LAI FU FEATURE ends if triggered in the same game.

If GONG GONG LAI FU FEATURE is triggered during the FREE GAMES FEATURE, any remaining free games resume after the GONG GONG LAI FU FEATURE ends.

**GONG GONG LAI FU FEATURE**



Any 6 or more Buddha trigger the GONG GONG LAI FU FEATURE and are held in position on the reels for the duration of the GONG GONG LAI FU FEATURE.

GONG GONG LAI FU FEATURE consists of 3 free spins.

During the GONG GONG LAI FU FEATURE, each symbol position becomes an individual spinning bonus reel.

In the GONG GONG LAI FU FEATURE, a prize map corresponding to the 15 symbol positions on the reels is displayed above the reels. Before the first free spin, each Buddha on the reels displays the prize from the corresponding location on the prize map. While a Buddha is held on the reels, the prize in the corresponding location on the prize map is also held. At the start of each free spin in GONG GONG LAI FU FEATURE, displayed prizes are redetermined for prize map squares that do not contain a held prize.

Each new Buddha appearing in a free spin displays a prize value that it is the sum of all held prizes displayed on the prize map from the previous free spin within the same GONG GONG LAI FU FEATURE only.

Each new Buddha appearing in a free spin resets the number of remaining free spins to 3 and is held in position for the duration of the GONG GONG LAI FU FEATURE. GONG GONG LAI FU FEATURE ends after all awarded free spins have been played or if Buddha appear in all 15 symbol positions. All prizes on Gong symbols are won at the end of feature.

**JACKPOT SURPRISE**



There is a chance that the GRAND JACKPOT is randomly won in bought games except when FREE GAMES FEATURE or GONG GONG LAI FU FEATURE is triggered.



# Speed

Entertainment has a classy new look.  
 Players can enjoy an exciting gaming experience.  
 Optimal service design for accessibility and maintenance.

### Stunning HD Graphics

An LCD monitor with dual 27-inch LCD high definition monitor.

### Ergonomic button deck

Premium Speed 11.6-inch LCD Touch Screen panel with Bash Button.

### Immersive Audio

Newly designed sound system creates powerful theater-like sound.

### USB charging

USB charging port & wireless Charger also provided for player convenience.

## DIMENSION

(Without Base Stand)

### Upright Height

(Tower Light Included)  
78.92 in (2004.5 mm)

### Upright Height

(Tower Light Excluded)  
74.67 in (1896.5 mm)

### Width

26.77 in (680 mm)

### Depth

24.82 in (630.5 mm)

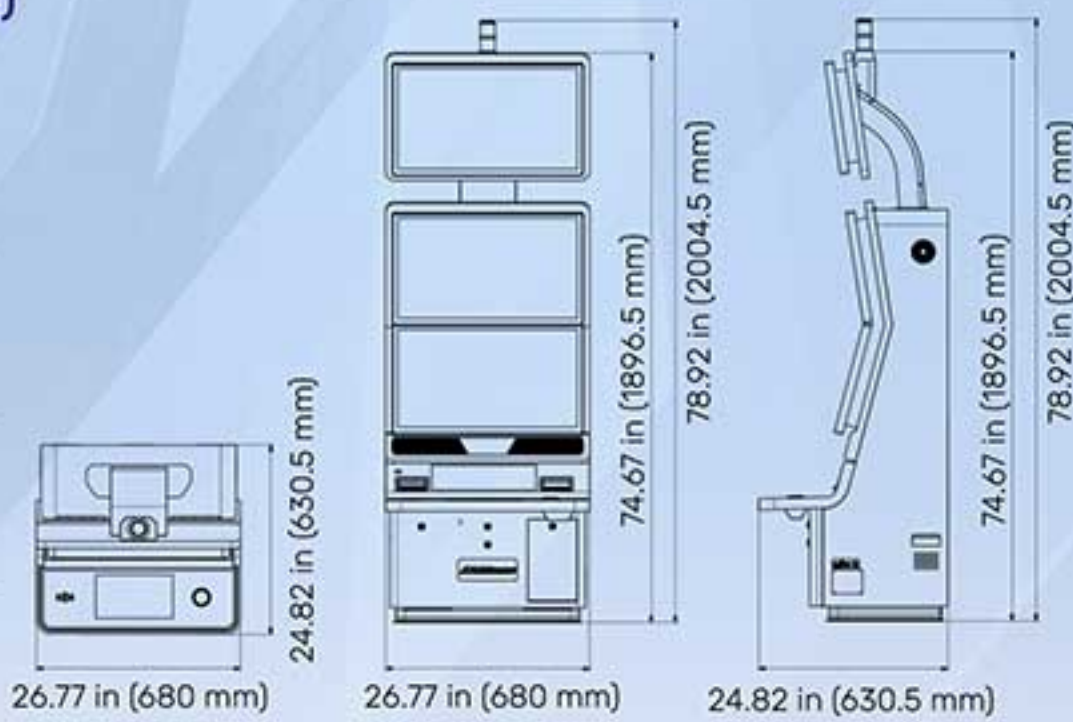

## DIMENSION

(With Custom Base Stand)

### Upright Height

(Tower Light Included)  
96.92 in (2461.7 mm)

### Upright Height

(Tower Light Excluded)  
92.67 in (2353.7 mm)

### Width

26.77 in (680 mm)

### Depth

24.84 in (631 mm)

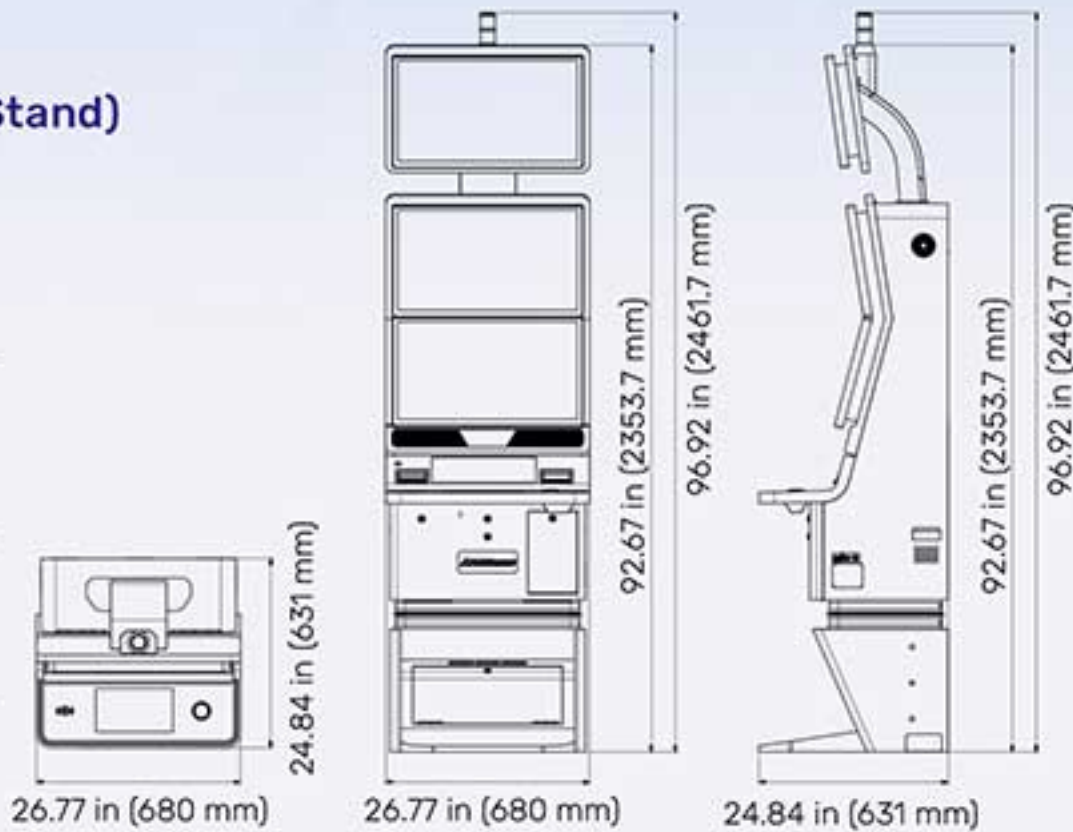

Please contact your Account Executive for more details.

sales@aruzeglobal.com

+1 702-781-8080

www.aruzeglobal.com

Follow us @AruzeGaming



Empire Technological Group Ltd dba  
 Aruze Gaming Global



# COIN COIN



Wild keys  
of fortune possess  
the power to unlock  
golden riches!





Wild keys of fortune possess the power to unlock golden riches. Jackpot, bonus and credit prizes on gold coins are won when appearing in any position on 3 or more consecutive reels beginning with the leftmost reel. More coins appear on the first three reels during free games and even more coins appear on all reels in a respin that is triggered randomly when wild appears during bought games.

### FREE GAMES



### TREASURE RESPIN



### JACKPOT AND BONUS PRIZES



### TYPE OF PRODUCT

[LINK](#) / [SAP](#)

### REEL CONFIGURATION

5-Reel 3-Row Video Slot

### PAYLINES

243 Ways

### DENOMINATIONS

1	2	3	4	5	6
1c	2c	5c	10c	\$1	\$2
5c	10c	25c	50c	\$5	\$10
10c	20c	50c	\$1	\$10	\$20
50c	\$1	\$2.50	\$5	\$50	\$100
\$1	\$2	\$5	\$10	\$100	\$200
1c	2c	5c	10c		
2c	5c	10c	20c		
5c	10c	25c	50c		
10c	20c	50c	\$1		
20c	50c	\$1	\$2		
50c	\$1	\$2.50	\$5		
\$1	\$2	\$5	\$10		
\$5	\$10	\$25	\$50		
\$10	\$20	\$50	\$100		

### BET CONFIGURATIONS

1, 2, 3, 4, 5

1, 2, 3, 5, 8

1, 2, 3, 5, 10

1, 2, 5, 10, 20

### MIN/MAX BET & Cost to Cover

MIN BET	MAX BET	Cost to Cover	Denomination
10	1000	50	Denomination 1, 2
5	500	25	Denomination 3, 4
1	100	5	Denomination 5, 6

(Depends on the above Bet Configurations)



Wild keys of fortune possess the power to unlock golden riches. Jackpot, bonus and credit prizes on gold coins are won when appearing in any position on 3 or more consecutive reels beginning with the leftmost reel. More coins appear on the first three reels during free games and even more coins appear on all reels in a respin that is triggered randomly when wild appears during bought games.

### FREE GAMES



### TREASURE RESPIN



### JACKPOT AND BONUS PRIZES



### TYPE OF PRODUCT

[LINK](#) / [SAP](#)

### REEL CONFIGURATION

5-Reel 3-Row Video Slot

### PAYLINES

243 Ways

### DENOMINATIONS

1	2	3	4	5	6
1c	2c	5c	10c	\$1	\$2
5c	10c	25c	50c	\$5	\$10
10c	20c	50c	\$1	\$10	\$20
50c	\$1	\$2.50	\$5	\$50	\$100
\$1	\$2	\$5	\$10	\$100	\$200
1c	2c	5c	10c		
2c	5c	10c	20c		
5c	10c	25c	50c		
10c	20c	50c	\$1		
20c	50c	\$1	\$2		
50c	\$1	\$2.50	\$5		
\$1	\$2	\$5	\$10		
\$5	\$10	\$25	\$50		
\$10	\$20	\$50	\$100		

### BET CONFIGURATIONS

1, 2, 3, 4, 5

1, 2, 3, 5, 8

1, 2, 3, 5, 10

1, 2, 5, 10, 20

### MIN/MAX BET & Cost to Cover

MIN BET	MAX BET	Cost to Cover	Denomination
10	1000	50	Denomination 1, 2
5	500	25	Denomination 3, 4
1	100	5	Denomination 5, 6

(Depends on the above Bet Configurations)



# DANCING PANDA™



**Happy blessings  
come from wild  
surprises!**





Happy blessings come from wild surprises! During bought games, multiple symbol kinds on all reels may randomly become wild symbols. During bought games and free games, line wins may be multiplied by randomly appearing multiplier wild symbols. When wild symbols appear, there is a chance to trigger a special prize reel that awards jackpots, free games or both. Multiple jackpots may be won on the special prize reel.

#### FREE GAMES



#### RANDOM FEATURES



#### PRIZE REEL



#### TYPE OF PRODUCT

[LINK](#) / [SAP](#)

#### REEL CONFIGURATION

5-Reel 3-4-4-4-3-Row Video Slot

#### PAYLINES

32 Lines

#### DENOMINATIONS

1¢

#### BET CONFIGURATIONS

1, 2, 3, 4, 5, 6, 7, 8, 9, 10

#### MIN/MAX BET & Cost to Cover

MIN BET	MAX BET	Cost to Cover
68	680	68

(Depends on the above Bet Configurations)



Happy blessings come from wild surprises! During bought games and free games, multiple lower-paying symbol kinds on all reels may randomly become a single higher-paying symbol kind. Alternatively, line wins may be multiplied by randomly appearing multiplier wild symbols. When wild symbols appear, there is a chance to trigger a special prize reel that awards jackpots, free games or both. Multiple jackpots may be won on the special prize reel.

#### FREE GAMES



#### RANDOM FEATURES



#### PRIZE REEL



#### TYPE OF PRODUCT

[LINK](#) / [SAP](#)

#### REEL CONFIGURATION

5-Reel 3-4-4-4-3-Row Video Slot

#### PAYLINES

32 Lines

#### DENOMINATIONS

1¢

#### BET CONFIGURATIONS

1, 2, 3, 4, 5, 6, 7, 8, 9, 10

#### MIN/MAX BET & Cost to Cover

MIN BET	MAX BET	Cost to Cover
68	680	68

(Depends on the above Bet Configurations)



# FU LAI CAI LAI 福来财来







Experience an enriching variety of gameplay and surprising riches. Increasing the bet level and credit per play improve several elements of gameplay.



#### TYPE OF PRODUCT

**LINK / SAP**

#### REEL CONFIGURATION

5-Reel 3-Row Video Slot

#### PAYLINES

243 Ways

#### DENOMINATIONS

1c

#### BET CONFIGURATIONS

1, 2, 3, 6, 10

#### MIN/MAX BET & Cost to Cover

MIN BET	MAX BET	Cost to Cover	BET LEVEL
11	110	11	Bet Level 1
33	330	33	Bet Level 2
55	550	55	Bet Level 3
66	660	66	Bet Level 4
88	880	88	Bet Level 5

(Depends on the above Bet Configurations)

#### GAME TITLES:



#### FU LAI CAI LAI TRIPLE FESTIVAL

appearing on 3 or more consecutive reels beginning with the leftmost reel trigger the FREE GAMES FEATURE with 8 FREE GAMES. During FREE GAMES FEATURE, reels contains Picture symbols only. FREE GAMES FEATURE can be triggered again during the FREE GAMES FEATURE.

If the FREE GAMES FEATURE is triggered in the same game as the JACKPOT FEATURE, the FREE GAMES FEATURE starts after the JACKPOT FEATURE ends.

#### FU LAI CAI LAI 5 SEA LEGENDS

appearing on 3 or more consecutive reels beginning with the leftmost reel trigger the FREE GAMES FEATURE with 6 FREE GAMES.

Before FREE GAMES start, select 1 of the symbols from the available options.

If the FREE GAMES FEATURE was triggered when playing bet level 2 or higher, the reels used during the FREE GAMES are composed with the following symbols only: the symbol selected from the available options,

and .

If the FREE GAMES FEATURE was triggered when playing bet level 1, the reels used during the FREE GAMES are composed with the following symbols only: the symbol selected from the available options, and .

During the FREE GAMES, appearing on 3 or more consecutive reels beginning with the leftmost reel award an additional 6 FREE GAMES, however the selection of the symbol option is not made again.

If the FREE GAMES FEATURE is triggered in the same game as the JACKPOT FEATURE, the FREE GAMES FEATURE starts after the JACKPOT FEATURE ends.

#### FU LAI CAI LAI STACK WILD LUXURY

appearing on 3 or more consecutive reels beginning with the leftmost reel trigger the FREE GAMES FEATURE with 8 FREE GAMES.

During the FREE GAMES, all symbols on 1 or more reels (reels 2, 3, 4 and 5 according to bet level played) may randomly become .

FREE GAMES FEATURE cannot be triggered again during the FREE GAMES FEATURE.

If the FREE GAMES FEATURE is triggered in the same game as the JACKPOT FEATURE, the FREE GAMES FEATURE starts after the JACKPOT FEATURE ends.



#### JACKPOT FEATURE

The JACKPOT FEATURE can be triggered when playing bet level 2, 3, 4 or 5 only. There is a chance the JACKPOT FEATURE may be triggered when appears.

Alternatively, the JACKPOT FEATURE is triggered when the large drops down to be displayed on the game screen randomly in bought games and free games.

According to the bet level played, up to 4 jackpot levels may be available. In the JACKPOT FEATURE, select from 15 ingots until 3 matching symbols corresponding to a jackpot level are revealed.

If 3 are revealed, an additional JACKPOT FEATURE is awarded and the feature continues until a jackpot level is won.

When 3 matching jackpot level symbols have been revealed, the corresponding jackpot level is won and the JACKPOT FEATURE ends. Any additional JACKPOT FEATURE awarded, starts after the preceding JACKPOT FEATURE ends.

#### WILD COIN BONUS

There is a chance the WILD COIN BONUS may occur when 1 or more appear on the reels in a bought game or free game. When the WILD COIN BONUS occurs, a special credit prize displayed on the game screen is awarded. Special Credit Prize: total credits bet multiplied by either 10, 20, 30, 50 or 100 randomly as displayed.



# FORTUNE DRUMS™







Spinning riches stir up excitement. Picture symbols are increased on reels according to the credits bet played. Special reels comprised exclusively of Picture, "Feature" and "Wild" symbols are used during the 10 Free Games. In DON DON DON, a big win awaits as either a bonus credit prize or 1 of 4 progressive levels is won.

#### FREE GAMES



#### DON DON DON



#### TYPE OF PRODUCT

**LINK / SAP**

#### REEL CONFIGURATION

5-Reel 3-Row Video Slot

#### PAYLINES

243 Ways

#### DENOMINATIONS

1c

#### BET CONFIGURATIONS

1, 2, 3, 4, 5

1, 2, 3, 5, 10

1, 2, 5, 10, 15

1, 2, 5, 10, 20

#### MIN/MAX BET & Cost to Cover

MIN BET	MAX BET	Cost to Cover	BET LEVEL
8	160	8	Bet Level 1
18	360	18	Bet Level 2
38	760	38	Bet Level 3
68	1360	68	Bet Level 4
88	1760	88	Bet Level 5

(Depends on the above Bet Configurations)



Spinning riches stir up excitement. Picture symbols are increased on reels according to the credits bet played. When the feature is triggered a Mini Game occurs, improving the reels used during 6 Free Games. In DON DON DON, a big win awaits as either a bonus credit prize or 1 of 4 progressive levels is won.

#### FREE GAMES



#### DON DON DON



#### TYPE OF PRODUCT

**LINK / SAP**

#### REEL CONFIGURATION

5-Reel 3-Row Video Slot

#### PAYLINES

243 Ways

#### DENOMINATIONS

1c

#### BET CONFIGURATIONS

1, 2, 3, 4, 5

1, 2, 3, 5, 10

1, 2, 5, 10, 15

1, 2, 5, 10, 20

#### MIN/MAX BET & Cost to Cover

MIN BET	MAX BET	Cost to Cover	BET LEVEL
8	160	8	Bet Level 1
18	360	18	Bet Level 2
38	760	38	Bet Level 3
68	1360	68	Bet Level 4
88	1760	88	Bet Level 5

(Depends on the above Bet Configurations)





Spinning riches stir up excitement. Picture symbols are increased on reels according to the credits bet played. 3 🍵 symbols held on reel 3 are used during 10 Free Games. In DON DON DON, a big win awaits as either a bonus credit prize or 1 of 4 progressive levels is won.

### FREE GAMES



### DON DON DON



### TYPE OF PRODUCT

**LINK / SAP**

### REEL CONFIGURATION

5-Reel 3-Row Video Slot

### PAYLINES

243 Ways

### DENOMINATIONS

1c

### BET CONFIGURATIONS

1, 2, 3, 4, 5

1, 2, 3, 5, 10

1, 2, 5, 10, 15

1, 2, 5, 10, 20

### MIN/MAX BET & Cost to Cover

MIN BET	MAX BET	Cost to Cover	BET LEVEL
8	160	8	Bet Level 1
18	360	18	Bet Level 2
38	760	38	Bet Level 3
68	1360	68	Bet Level 4
88	1760	88	Bet Level 5

(Depends on the above Bet Configurations)



Spinning riches stir up excitement. Picture symbols are increased on reels according to the credits bet played. Special reels with consecutive wild symbols and no Royal symbols are used during the 8 Free Games. In DON DON DON, a big win awaits as either a bonus credit prize or 1 of 4 progressive levels is won.

### FREE GAMES



### DON DON DON



### TYPE OF PRODUCT

**LINK / SAP**

### REEL CONFIGURATION

5-Reel 3-Row Video Slot

### PAYLINES

243 Ways

### DENOMINATIONS

1c

### BET CONFIGURATIONS

1, 2, 3, 4, 5

1, 2, 3, 5, 10

1, 2, 5, 10, 15

1, 2, 5, 10, 20

### MIN/MAX BET & Cost to Cover

MIN BET	MAX BET	Cost to Cover	BET LEVEL
8	160	8	Bet Level 1
18	360	18	Bet Level 2
38	760	38	Bet Level 3
68	1360	68	Bet Level 4
88	1760	88	Bet Level 5

(Depends on the above Bet Configurations)



# BOMB COLLECTOR™



**Ignite the  
bombs to trigger  
explosive features!**





Ignite the bombs to trigger explosive features! When bombs explode, they can trigger one of the explosive features: WILD BOOM, PRIZE BLAST, FREE GAMES EXPLOSION and JACKPOT FEATURE. More Jackpots can be also won when wild appears: GRAND, MAJOR, MINOR, MINI.

### WILD BOOM



### PRIZE BLAST



### FREE GAMES EXPLOSION



### JACKPOT FEATURE



### TYPE OF PRODUCT

[LINK](#) / [SAP](#)

### REEL CONFIGURATION

5-Reel 3-Row Video Slot

### PAYLINES

30 Lines

### DENOMINATIONS

1c

### BET CONFIGURATIONS

1, 2, 3, 4, 5, 6, 7, 8, 9, 10

### MIN/MAX BET & Cost to Cover

MIN BET	MAX BET	Cost to Cover
88	880	88

(Depends on the above Bet Configurations)



Ignite the bombs to trigger explosive features! When bomb explode it may awards one of the following prizes: WILD BOOM, PRIZE BLAST, FREE GAMES EXPLOSION and JACKPOT FEATURE. When wild appears it may also awards 1 of the Jackpots: GRAND, MAJOR, MINOR, MINI.

### WILD BOOM



### PRIZE BLAST



### FREE GAMES EXPLOSION



### JACKPOT FEATURE



### TYPE OF PRODUCT

[LINK](#) / [SAP](#)

### REEL CONFIGURATION

5-Reel 3-Row Video Slot

### PAYLINES

30 Lines

### DENOMINATIONS

1c

### BET CONFIGURATIONS

1, 2, 3, 4, 5, 6, 7, 8, 9, 10

### MIN/MAX BET & Cost to Cover

MIN BET	MAX BET	Cost to Cover
88	880	88

(Depends on the above Bet Configurations)



# COIN COLLECTOR™



**Unlock greater  
riches with golden  
coins!**





Unlock greater riches with golden coins! Jackpot, bonus and credit prizes on gold coins are won when appearing in any position on 3 or more consecutive reels beginning with the leftmost reel. More coins appear on the first three reels during free games and even more coins appear on all reels in a respin that is triggered randomly when wild appears during bought games.

#### 5 GUARDIANS FEATURE



#### MYSTERY SYMBOL



#### DREAM COLLECTOR



#### JACKPOT SURPRISE



#### TYPE OF PRODUCT

[LINK](#) / [SAP](#)

#### REEL CONFIGURATION

5-Reel 4-Row Video Slot

#### PAYLINES

50 Lines

25 Lines

4 Lines (Denomination 4, 5, 6 only)

#### DENOMINATIONS

1	2	3	4	5	6
1c	2c	5c	10c	\$1	\$2
5c	10c	25c	50c	\$5	\$10
10c	20c	50c	\$1	\$10	\$20
50c	\$1	\$2.50	\$5	\$50	\$100
2c	5c	10c	20c	\$2	\$5
20c	50c	\$1	\$2	\$20	\$50
1c	2c	5c	10c		
10c	20c	50c	\$1		
50c	\$1	\$2.50	\$5		
\$1	\$2	\$5	\$10		
\$5	\$10	\$25	\$50		
\$10	\$20	\$50	\$100		
2c	5c	10c	20c		
20c	50c	\$1	\$2		

#### BET CONFIGURATIONS

1, 2, 3, 4, 5

1, 2, 3, 5, 10

#### MIN/MAX BET & Cost to Cover

MIN BET	MAX BET	Cost to Cover	Denomination
50	500	50	All Denomination
25	250	25	All Denomination
4	40	4	Denomination 4, 5, 6

(Depends on the above Bet Configurations)



Unlock greater riches with golden coins! Jackpot, bonus and credit prizes on gold coins are won when appearing in any position on 3 or more consecutive reels beginning with the leftmost reel. More coins appear on the first three reels during free games and even more coins appear on all reels in a respin that is triggered randomly when wild appears during bought games.

#### 5 GUARDIANS FEATURE



#### MYSTERY SYMBOL



#### DREAM COLLECTOR



#### JACKPOT SURPRISE



#### TYPE OF PRODUCT

[LINK](#) / [SAP](#)

#### REEL CONFIGURATION

5-Reel 4-Row Video Slot

#### PAYLINES

50 Lines

25 Lines

4 Lines (Denomination 4, 5, 6 only)

#### DENOMINATIONS

1	2	3	4	5	6
1c	2c	5c	10c	\$1	\$2
5c	10c	25c	50c	\$5	\$10
10c	20c	50c	\$1	\$10	\$20
50c	\$1	\$2.50	\$5	\$50	\$100
2c	5c	10c	20c	\$2	\$5
20c	50c	\$1	\$2	\$20	\$50
1c	2c	5c	10c		
10c	20c	50c	\$1		
50c	\$1	\$2.50	\$5		
\$1	\$2	\$5	\$10		
\$5	\$10	\$25	\$50		
\$10	\$20	\$50	\$100		
2c	5c	10c	20c		
20c	50c	\$1	\$2		

#### BET CONFIGURATIONS

1, 2, 3, 4, 5

1, 2, 3, 5, 10

#### MIN/MAX BET & Cost to Cover

MIN BET	MAX BET	Cost to Cover	Denomination
50	500	50	All Denomination
25	250	25	All Denomination
4	40	4	Denomination 4, 5, 6

(Depends on the above Bet Configurations)



# Jack's HAUNTED WINS

# Jack's WINNING SPELL



**SCARE UP  
SOME FRIGHTENINGLY BIG  
MONSTER WINS!**





Scare up some frighteningly big monster wins! In addition to free games, there is a chance to trigger a wide variety of unique features whenever wild symbols appear. Enjoy special prize reels, scattered wild, cascading wild, merging reels, a bonus collect feature and a special multiplier reel that increases all bonus wins and also awards jackpots.

#### MEGA SYMBOL



#### PRIZE REEL



#### WILD REEL SPIN



#### RANDOM WILD



#### HOLD SPIN BONUS



#### FREE GAMES



#### TYPE OF PRODUCT

[LINK](#) / [SAP](#)

#### REEL CONFIGURATION

5-Reel 3-4-4-4-3-Row Video Slot

#### PAYLINES

40 Lines

#### DENOMINATIONS

1¢

#### BET CONFIGURATIONS

1, 2, 3, 4, 5, 6, 7, 8, 9, 10

#### MIN/MAX BET & Cost to Cover

MIN BET	MAX BET	Cost to Cover	BET LEVEL
40	400	40	Bet Level 1
60	600	60	Bet Level 2

(Depends on the above Bet Configurations)



Scare up some frighteningly big monster wins! In addition to free games, there is a chance to trigger a wide variety of unique features whenever wild symbols appear. Enjoy special prize reels, scattered wild, cascading wild, merging reels, a bonus collect feature and a special multiplier reel that increases all bonus wins and also awards jackpots.

#### MEGA SYMBOL



#### PRIZE REEL



#### WILD REEL SPIN



#### RANDOM WILD



#### HOLD SPIN BONUS



#### FREE GAMES



#### TYPE OF PRODUCT

[LINK](#) / [SAP](#)

#### REEL CONFIGURATION

5-Reel 3-4-4-4-3-Row Video Slot

#### PAYLINES

40 Lines

#### DENOMINATIONS

1¢

#### BET CONFIGURATIONS

1, 2, 3, 4, 5, 6, 7, 8, 9, 10

#### MIN/MAX BET & Cost to Cover

MIN BET	MAX BET	Cost to Cover	BET LEVEL
40	400	40	Bet Level 1
60	600	60	Bet Level 2

(Depends on the above Bet Configurations)





Being the only one of its kind; unlike anything else.



A stunning lighting display to attract players. Thoughtful touches to keep them comfortable.

All designed for an unparalleled 55-inch full screen dynamic gaming experience.



**Stunning HD Graphics**

An LCD monitor with a 27-inch LCD monitor and breathtaking images on a vertical 55-inch LCD monitor.

**Distinctive LED Ambience**

Unique visual experience not replicated in the market. Muso Limited creates a stunning light display with its never before seen 360-degree LED backlighting.



**Ergonomic button deck**

Inviting wrist rest and expansive glass table. Completely new interface design displayed on a 338-mm (13.3-inch) LCD deck.



**USB charging**

USB charging port & panel also provided for player convenience.



**Amp up the gaming experience**

Newly designed sound system creates powerful theater-like sound.



**DIMENSIONS**

**4 UNITS (Without Signage)**

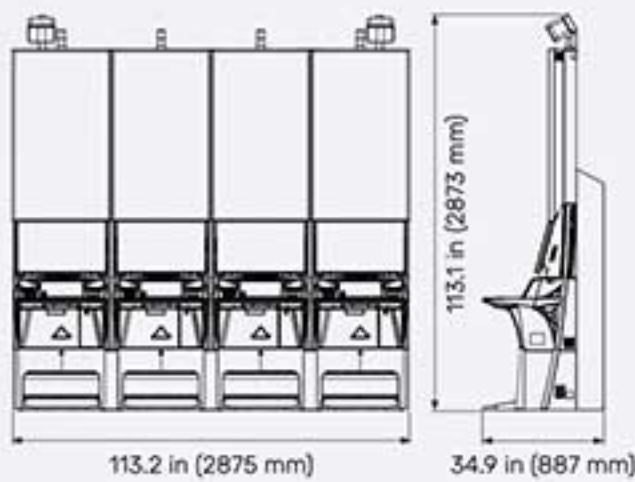

**4 UNITS (With Signage)**

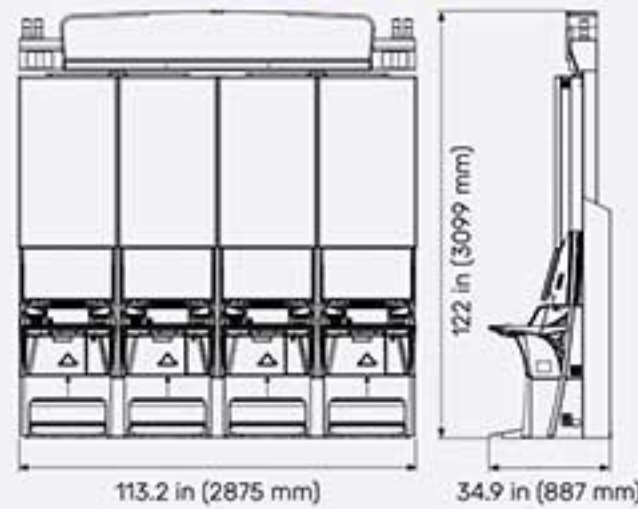

**6 UNITS (Without Signage)**

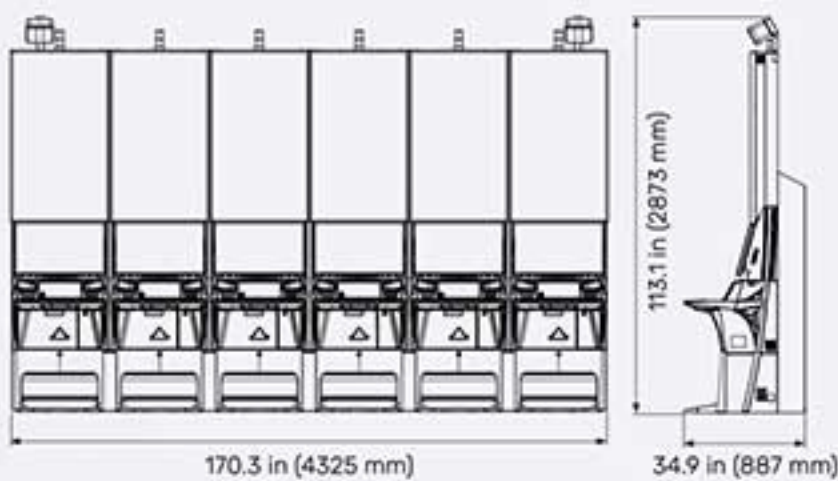

**6 UNITS (With Signage)**

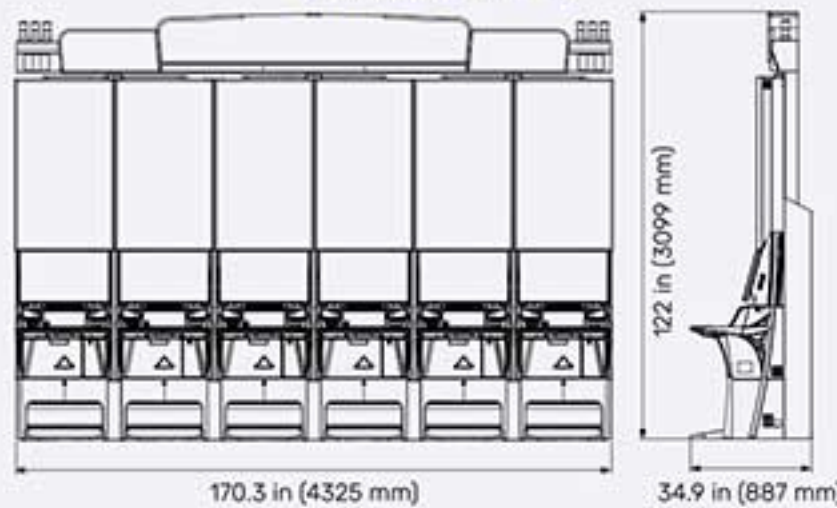

Please contact your Account Executive for more details.

sales@aruzeglobal.com

+1 702-781-8080

www.aruzeglobal.com

Follow us @AruzeGaming



Empire Technological Group Ltd dba Aruze Gaming Global



# JIJIFU™



## JIJIFU™





# JIJIFU RAGING DRAGON

# JIJIFU RAGING PHOENIX

**TYPE OF PRODUCT**

LINK / SAP

**REEL CONFIGURATION**

5-Reel 5-Row Video Slot

**PAYLINES**

7 Lines

**DENOMINATIONS**

1c

**BET CONFIGURATIONS**

1, 2, 3, 4, 5, 6, 7, 8, 9, 10

**MIN/MAX BET & Cost to Cover**

MIN BET	MAX BET	Cost to Cover
88	880	88

(Depends on the above Bet Configurations)

**4 UNITS**











**6 UNITS**



**COLLECT FEATURE**



 appearing on 3 or more consecutive reels beginning with the leftmost reel trigger the COLLECT FEATURE. The triggering  becomes  and are held in position for the duration of the COLLECT FEATURE. When COLLECT FEATURE is triggered, 3 free spins are awarded. Each newly appearing  in a free spin resets the number of remaining free spins to 3 and is held in position until the COLLECT FEATURE ends. COLLECT FEATURE starts after JACKPOT WHEEL ends if triggered in the same bought game. COLLECT FEATURE ends after all awarded free spins have been played or  appears in all 25 symbol positions. Prizes displayed on  are paid one time only for held  on the reels at the end of COLLECT FEATURE only. GRAND JACKPOT is won if  appears in all 25 symbol positions.

 prizes are added to the GRAND JACKPOT WIN.  prizes won at the end of the COLLECT FEATURE are added to the prizes from the game that triggered the COLLECT FEATURE.



**SUPER COLLECT FEATURE**





Any combination of  and  appearing on 3 or more consecutive reels beginning with the leftmost reel trigger the SUPER COLLECT FEATURE.

Before the SUPER COLLECT FEATURE starts, each of the triggering  becomes  and each of the triggering  becomes , and all are held in position until the SUPER COLLECT FEATURE ends.



When SUPER COLLECT FEATURE is triggered, 3 free spins are awarded.

Each newly appearing  /  in a free spin resets the number of remaining free spins to 3 and is held in position until the SUPER COLLECT FEATURE ends. SUPER COLLECT FEATURE starts after JACKPOT WHEEL ends if triggered in the same bought game.

COLLECT FEATURE ends after all awarded free spins have been played or  /  appears in all 25 symbol positions.

Prizes displayed on  /  are paid one time only for held  /  on the reels at the end of SUPER COLLECT FEATURE only.

If  /  appears in all 25 symbol positions, prizes displayed on  /  are doubled and paid one time only.

 /  prizes won at the end of SUPER COLLECT FEATURE are added to the prizes from the game that triggered the SUPER COLLECT FEATURE.

**JACKPOT WHEEL**



There is a chance that the JACKPOT WHEEL may be triggered when 1 or more  appears in bought games only. When the JACKPOT WHEEL is triggered, a wheel appears on the screen and is spun once only. After the wheel is spun, 1 wheel segment indicated by the pointer at the top of the wheel is selected.

The wheel contains the following:  
**BONUSES:** MINI BONUS and MINOR BONUS  
**JACKPOTS:** MAJOR JACKPOT and GRAND JACKPOT  
 JACKPOT WHEEL ends after a JACKPOT or BONUS is won.





**ARUZE**  
iINTERACTIVE-

Whether you are at home  
or on the go, you can always  
locate your favorite  
**AG2 games!**



Zynga - HIT IT RICH



LUCKY NORTH CASINO



BEST BET CASINO



SUPER LUCKY CASINO



TROPWORLD CASINO



GSN - WHEEL OF FORTUNE



MAGICIAN CASINO 2







# AG2

## Elevate the Game

### **Aruze Gaming Global HQ**

1106 Palms Airport Dr Las Vegas, NV 89119

TEL: +1 702-781-8080

EMAIL: [info@aruzeglobal.com](mailto:info@aruzeglobal.com)

### **Aruze Gaming Global Central Office**

10447 Lemoyne Blvd  
Biloxi, MS 39532  
TEL: +1 702-781-8080

### **Customer Technical Support**

Available 24 hours a day / 7 days a week  
TEL: +1 877-438-0569  
EMAIL: [service@aruzeglobal.com](mailto:service@aruzeglobal.com)

### **Empire Technological Group Japan K.K**

2-21-6, Kandamisakicho Gaia Force Building 2F,  
Chiyoda-ku, Tokyo, 101-0061 Japan

### **Empire Shared Services Philippines, Inc.**

Ayala Tower One 1105-1106, 6767 Ayala Avenue  
Corner Paseo de Roxas, Makati, Philippines

### **Aruze Gaming Africa PTY LTD.**

P.O. Box 11484, Vorna Valley 1684 Unit 1/2/3 Kyalami  
Village 57 Forrsmen Close, Barbeque Downs Ext. 1  
Kyalami, Midrand, Gauteng, South Africa  
TEL: +27 11-466-3388 FAX: +27 11-466-3389

### **Aruze Gaming Australia PTY LTD.**

Unit 6, 463 Victoria Street, Wetherill Park,  
NSW 2164, Australia  
TEL: +61 2-8332-6000  
EMAIL: [sales@aruzegaming.com.au](mailto:sales@aruzegaming.com.au)

### **Empire Technological Group Limited - Macau Branch**

Avenida Xian Xing Hai, Centro Golden Dragon, 11  
Andar N, Macau  
TEL: +853 2881 2381  
EMAIL: [muilee.quah@aruzeglobal.com](mailto:muilee.quah@aruzeglobal.com)

### **CONFIDENTIAL**

For Aruze Customer's Internal use only  
Do Not Otherwise Reproduce or Disclose

Follow us  
[@AruzeGaming](#)



[www.aruzeglobal.com](http://www.aruzeglobal.com)

