



ARUZEGAMING®
GLOBAL

LEGACY REBORN

IGA 2024 | Product Catalog



CONTENTS

CABINET FEATURES

MUSO CURVE-55 Hybrid	4
HYPER SPEED (With Base Stand)	5
HYPER SPEED (Without Base Stand)	6
SPEED (With Base Stand)	7
SPEED (Without Base Stand)	8

MUSO CURVE-55 HYBRID, MUSO CURVE-43 and MUSO CURVE-43 HYBRID

Gong Cash Series	9
Gong Cash Dragon	10
Gong Cash Lion	11
Firestorm Series	12
Firestorm Bull	13
Firestorm Lion	14
Gong Gong Lai Fu Series	15
Gong Gong Lai Fu Caishen Riches	16
Gong Gong Lai Fu Mighty Buddha	17
Fu Lai Cai Lai Fortune Series	18
Fu Lai Cai Lai Fortune 5 Sea Legends	19
Fu Lai Cai Lai Fortune Triple Festival	20
Fu Lai Cai Lai Fortune Stack Wild Luxury	21
God of Winning Series	22
God of Winning Great Hammer	23
God of Winning Super Spear	24
Triple Treasure Pot Series	25
Triple Treasure Pot Heavenly Wealth	26
Triple Treasure Pot Eternal Prosperity	27
Long Fu Zhu Series	28
Long Fu Zhu Mongol Storm	29
Long Fu Zhu Panda Strike	30
Xin Yun Qiu Series	31
Xin Yun Qiu Dragon	32
Xin Yun Qiu Lion	33
Bingo Jackpot Series	34
Bingo Jackpot Las Vegas	35
Bingo Jackpot New York	36

MUSO TRIPLE-32 HYBRID

MUSO TRIPLE-32 Hybrid (Cabinet Feature)	37
Bomb Collector Series	38
Bomb Collector Gold Heist	39
Bomb Collector Treasure Heist	40
Fortune Frame Series	41
Fortune Frame Dragon Bounty	42
Fortune Frame Panda Carnival	43
Dancing Panda Supreme Series	44
Dancing Panda Supreme Festival	45
Dancing Panda Supreme Fortune	46
Tomb Treasure Series	47
Tomb Treasure Cleopatra Legend	48
Tomb Treasure Pharaoh Gold	49
Tomb Treasure Sphinx Gold	50

HYPER SPEED

HYPER SPEED HYBRID (Cabinet Feature)	51
HYPER SPEED (Cabinet Feature)	52
Fu Jin Shu Series	53
Fu Jin Shu Dragon	54
Fu Jin Shu Phoenix	55
Cai Yun Lai Series	56
Cai Yun Lai Dragon	57
Cai Yun Lai Lion	58
Cai Yun Lai Panda	59
Fu Ru Yi Series	60
Fu Ru Yi Phoenix	61
Fu Ru Yi Kirin	62

SPEED

SPEED HYBRID (Cabinet Feature)	63
SPEED (Cabinet Feature)	64
Orb of Wealth Series	65
Orb of Wealth Mythic Beasts	66
Orb of Wealth Shining Fortune	67
Bound For Riches Series	68
Bound For Riches Aztec Legend	69
Bound For Riches Chinese Celebration	69
Bound For Riches Egyptian Majesty	70
Bound For Riches Spanish Matador	70
Co Co Coin Series	71
Co Co Coin Egyptian Treasure	72
Co Co Coin Pirates Treasure	73
Dancing Panda Series	74
Dancing Panda Fortune	75
Dancing Panda Festival	76
Fu Lai Cai Lai Series	77
Fu Lai Cai Lai 5 Sea Legends	78
Fu Lai Cai Lai Triple Festival	78
Fu Lai Cai Lai Stack Wild Luxury	78
Fortune Drums Series	79
Fortune Drums Dragon Boat	80
Fortune Drums Zodiac Beasts	80
Fortune Drums Bag of Wealth	81
Fortune Drums Chinese Luxury	81
Coin Collector Series	82
Coin Collector 5 Guardians	83
Coin Collector Aussie 5	83
Sunlight Series	84
Sunlight Savanna 5	85
Sunlight Joyful Lion	85
Jack's Series	86
Jack's Haunted Wins	87
Jack's Winning Spell	87

MUSO LIMITED

MUSO Limited (Cabinet Feature)	88
Dragong Series	89
Dragong Lion	90
Dragong Phoenix	90
JI JI FU Series	91
JI JI FU Raging Dragon	92
JI JI FU Raging Phoenix	92

CLASS 2 GAMES

Class 2 System Overview	93
-------------------------	----

TABLE GAMES

Golden Frog Baccarat	94
Empire Multiplier Blackjack	95
Step it up Blackjack	96
Short Deck Vegas 6+ Hold'em	97

iGAMING

iGAMING	98
---------	----





MUSO™
CURVE-55HB

mu·so [mōō - sō] *adj.*
being the only one of its kind;
unlike anything else.



New Face



New honeycomb LED (Details)



New vertical
55-inch
J-Style
curved
LCD monitor

A stunning new honeycomb cabinet LED display to attract players.

Thoughtful touches to keep them comfortable.

All designed for an unparalleled 55-inch full screen dynamic gaming experience.

BUILT FOR EXCELLENCE

DIMENSION

Upright Height (Tower Light Included)
108.3 in (2756.9 mm)

Upright Height (Tower Light Excluded)
104.4 in (2652.5 mm)

Width
31.9 in (810 mm)

Depth
33 in (838.2 mm)

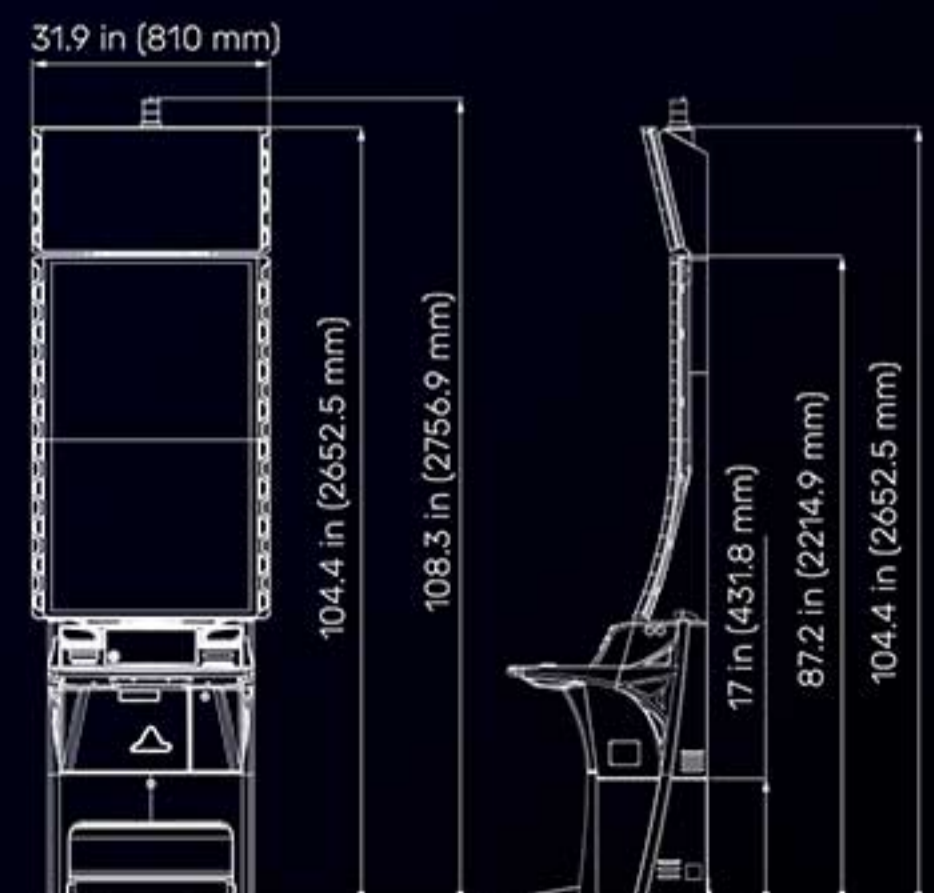
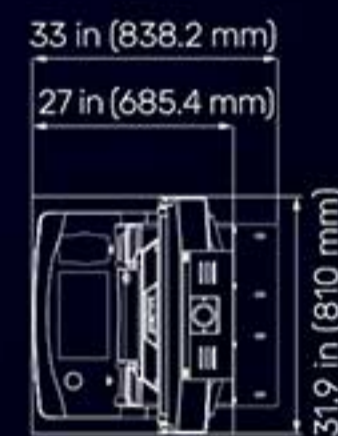

HYPERSPEED

Entertainment has a classy new look.

Players can enjoy an exciting gaming experience.

Optimal service design for accessibility and maintenance.

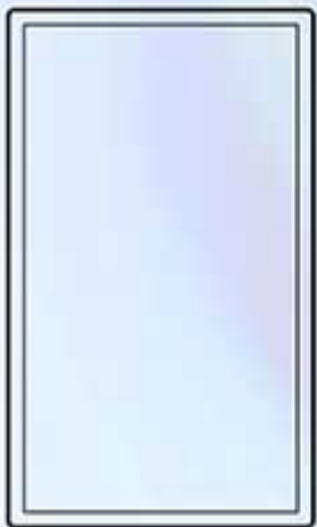

Stunning HD Graphics

An vertical LCD monitor with 43-inch LCD high definition monitor.



Immersive Audio

Newly designed sound system creates powerful theater-like sound.

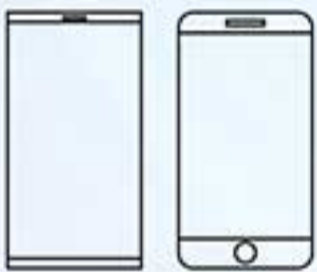

USB charging

USB charging port & wireless Charger also provided for player convenience.

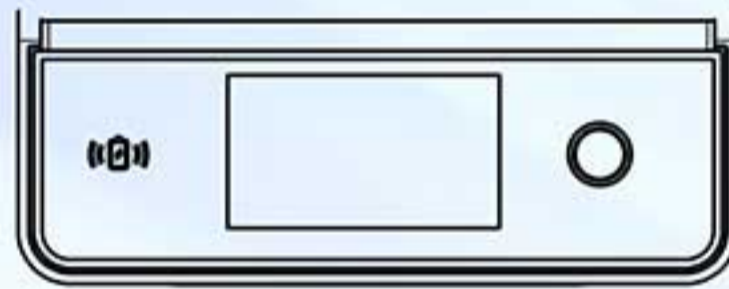

Ergonomic button deck

Premium Speed 11.6-inch LCD Touch Screen panel with Bash Button.



DIMENSION

(with Custom Stand Base version)

Upright Height

(Tower Light Included)

105.40 in (2677.1 mm)

Upright Height

(Tower Light Excluded)

101.34 in (2574.1 mm)

Width

26.77 in (680 mm)

Depth

24.85 in (631.1 mm)

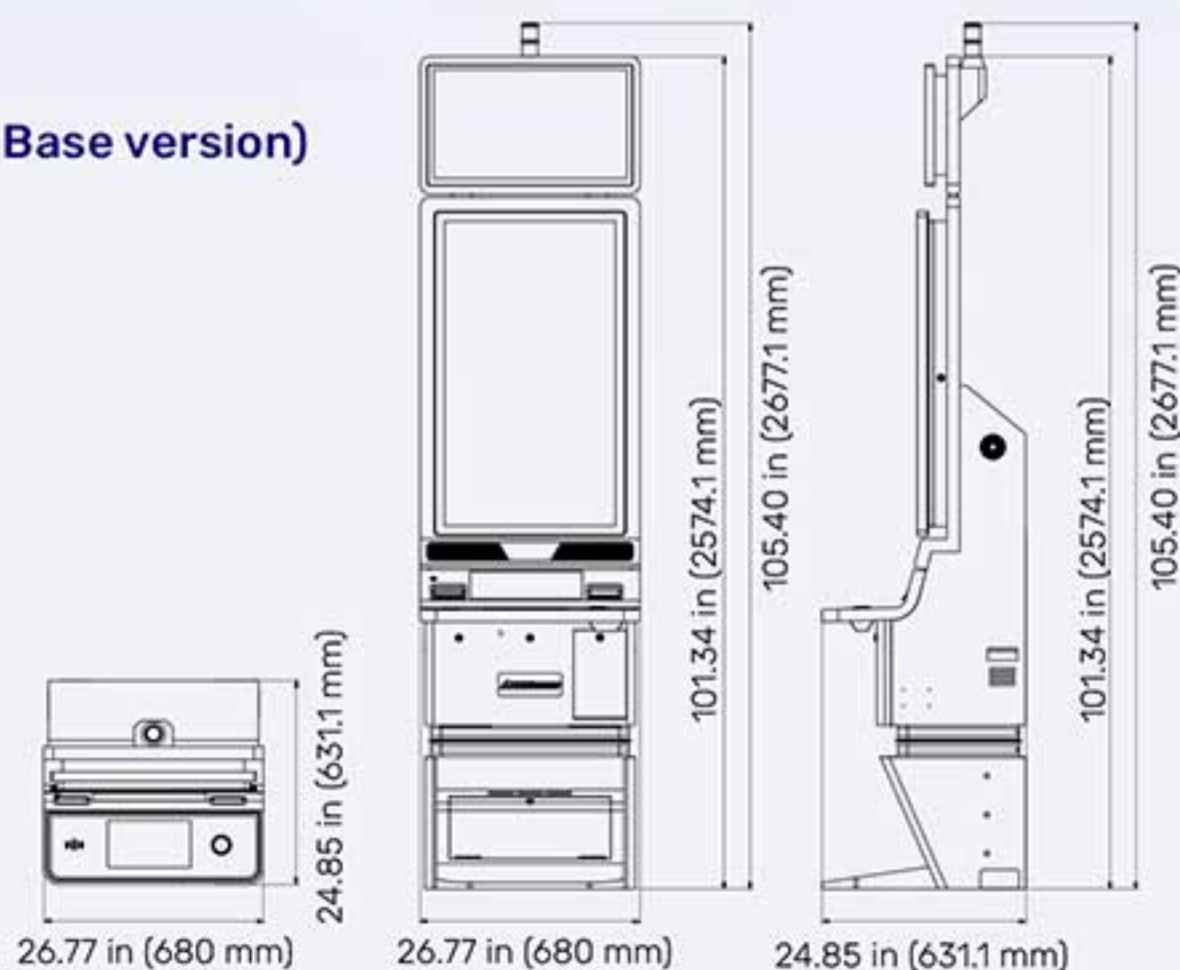

HYPERSPEED

Entertainment has a classy new look.

Players can enjoy an exciting gaming experience.

Optimal service design for accessibility and maintenance.



Stunning HD Graphics

An vertical LCD monitor with 43-inch LCD high definition monitor.



Immersive Audio

Newly designed sound system creates powerful theater-like sound.

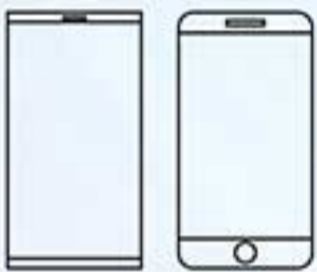

USB charging

USB charging port & wireless Charger also provided for player convenience.

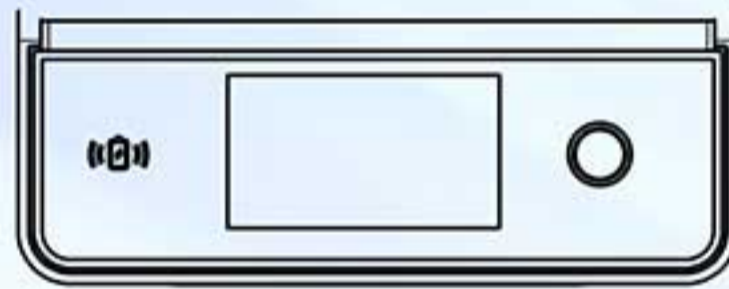

Ergonomic button deck

Premium Speed 11.6-inch LCD Touch Screen panel with Bash Button.



DIMENSION

(Upright version)

Upright Height
(Tower Light Included)
87.40 in (2219.9 mm)

Upright Height
(Tower Light Excluded)
83.34 in (2116.9 mm)

Width
26.77 in (680 mm)

Depth
24.85 in (631.1 mm)

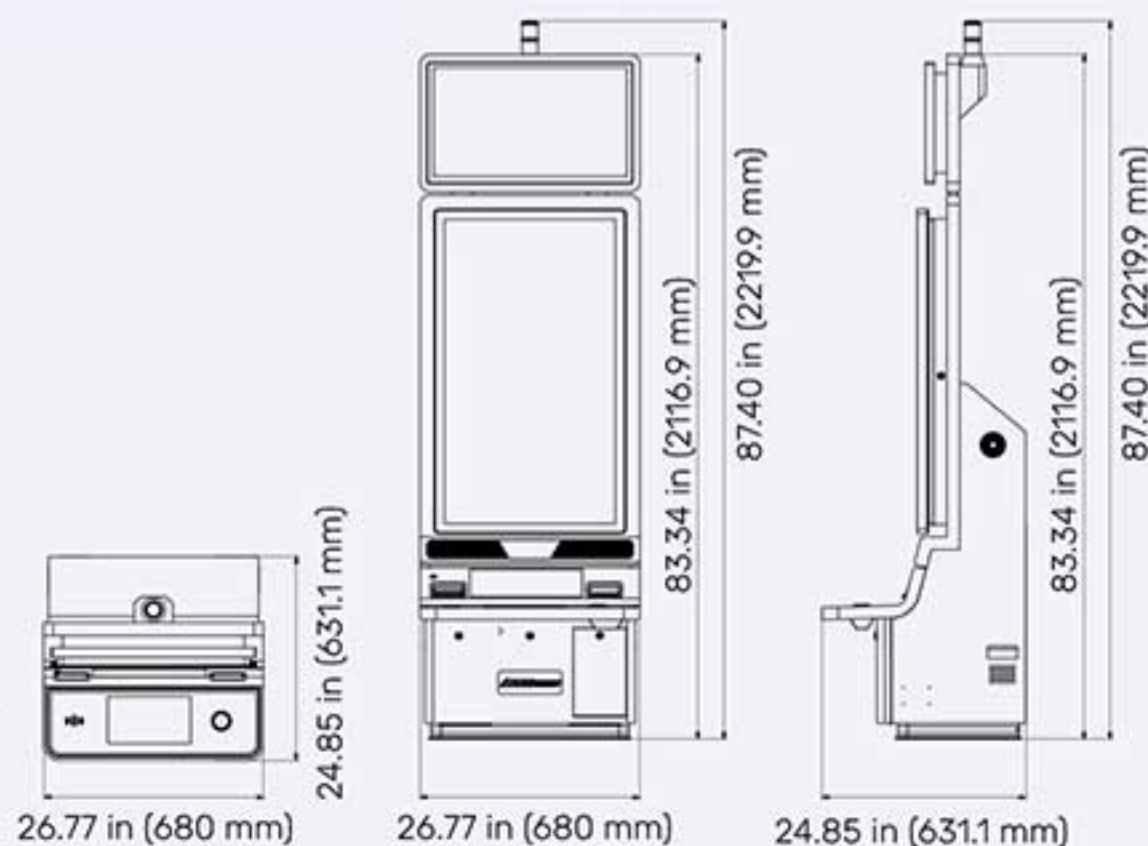

Speed

Entertainment has a classy new look.

Players can enjoy an exciting gaming experience.

Optimal service design for accessibility and maintenance.



Stunning HD Graphics

An LCD monitor with dual 27-inch LCD high definition monitor.



Immersive Audio

Newly designed sound system creates powerful theater-like sound.



USB charging

USB charging port & wireless Charger also provided for player convenience.

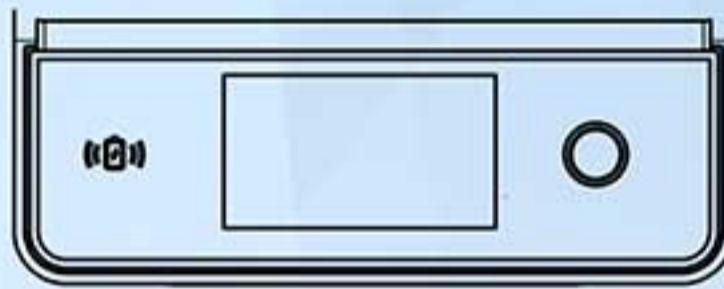

Ergonomic button deck

Premium Speed 11.6-inch LCD Touch Screen panel with Bash Button.

DIMENSION

(with Custom Stand Base version)

Upright Height
(Tower Light Included)
96.92 in (2461.7 mm)

Upright Height
(Tower Light Excluded)
92.67 in (2353.7 mm)

Width
26.77 in (680 mm)

Depth
24.84 in (631 mm)

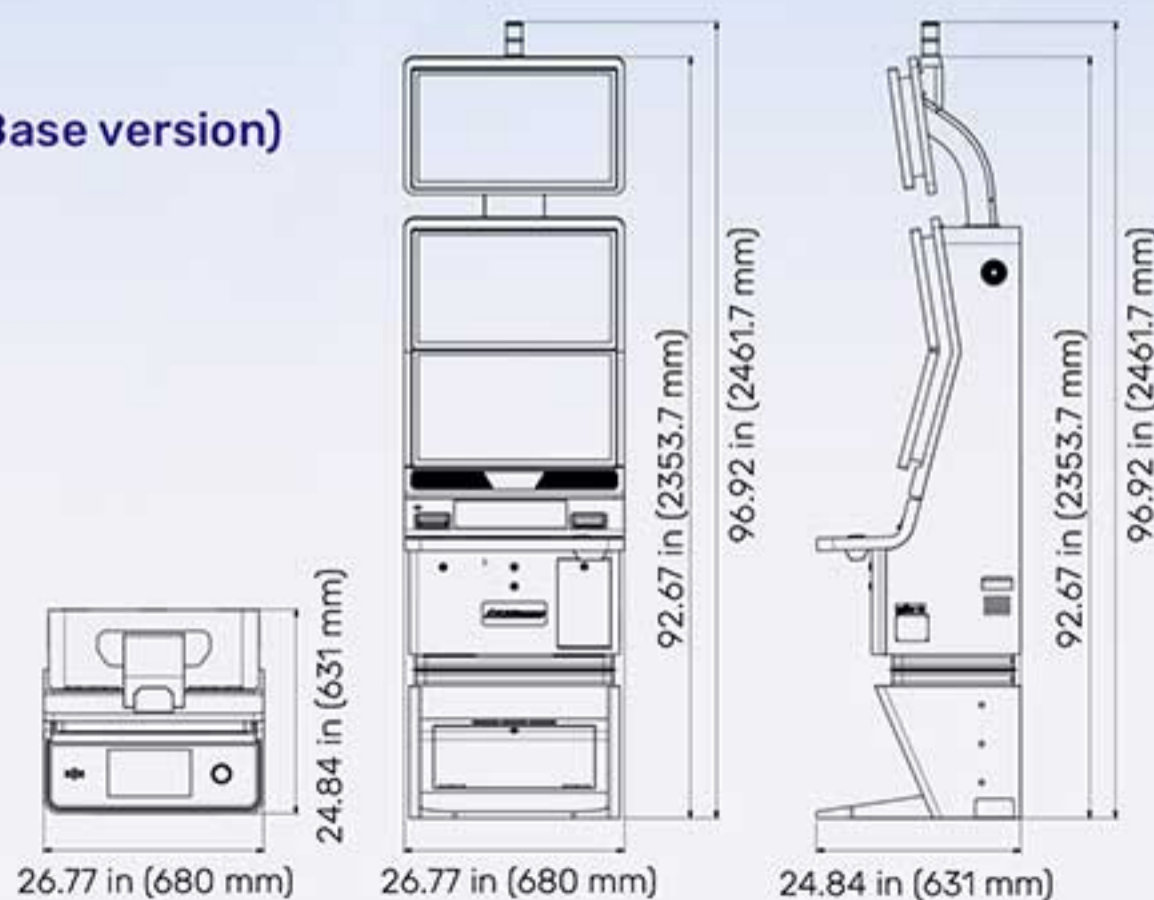

Speed

Entertainment has a classy new look.

Players can enjoy an exciting gaming experience.

Optimal service design for accessibility and maintenance.



Stunning HD Graphics

An LCD monitor with dual 27-inch LCD high definition monitor.



Immersive Audio

Newly designed sound system creates powerful theater-like sound.



USB charging

USB charging port & wireless Charger also provided for player convenience.



Ergonomic button deck

Premium Speed 11.6-inch LCD Touch Screen panel with Bash Button.



DIMENSION

(Upright version)

Upright Height
(Tower Light Included)
78.92 in (2004.5 mm)

Upright Height
(Tower Light Excluded)
74.67 in (1896.5 mm)

Width
26.77 in (680 mm)

Depth
24.82 in (630.5 mm)

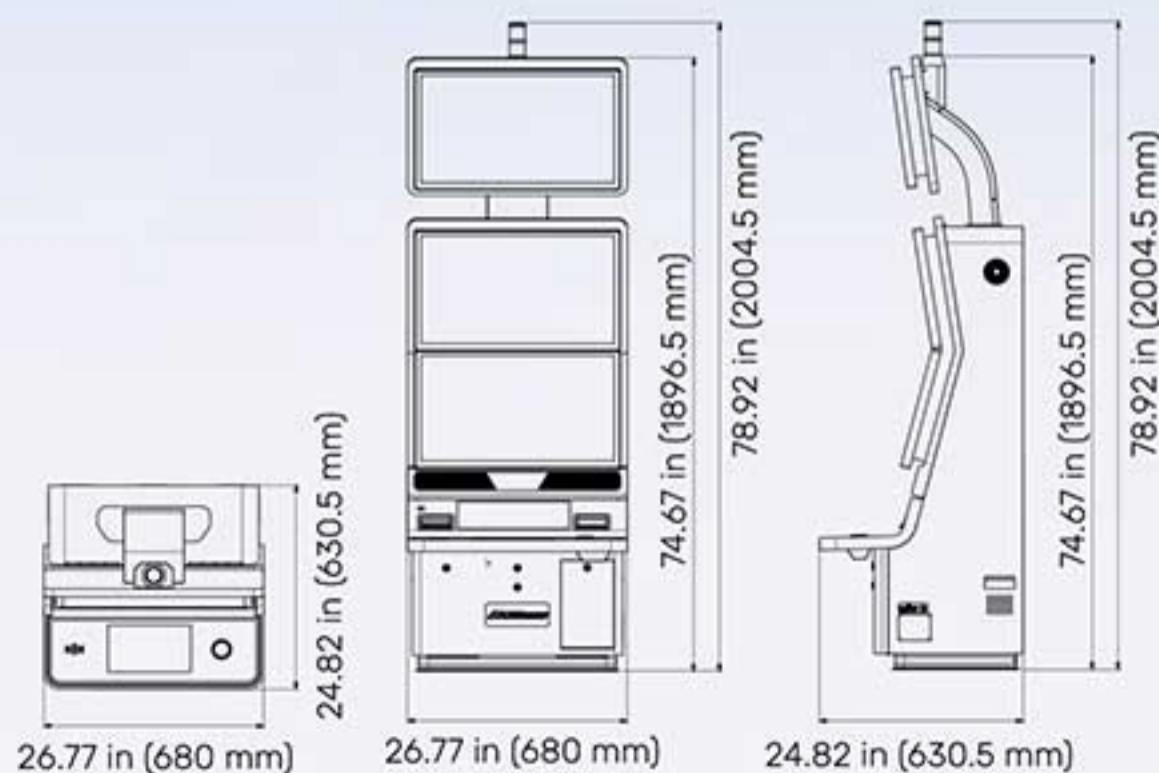

GONG CASH™ DRAGON

GONG CASH™ LION

GRAND
\$2,500.01

MAJOR
\$250.01

MINOR **MINI**
\$20.03 \$10.04

GRAND
\$2,500.01

MAJOR
\$250.01

MINOR **MINI**
\$20.03 \$10.05

**GONG CASH™
DRAGON**

**GONG CASH™
LION**

1c CREDIT 912 REEL 88 WIN 0

**GONG CASH™
LION**

1c CREDIT 912 REEL 88 WIN 0





Fortunes abound with overflowing pots of gold coins in this exciting theme. With mystery symbols that randomly change and surprise bonuses, riches may be just one spin away. Special scatters add to the fun and can trigger even more free spins & prizes.

GONG SPIN FEATURE



3 scattered appearing on reels 2, 3 and 4 trigger the GONG SPIN FEATURE. When the GONG SPIN FEATURE is triggered, 3 free spins are awarded. Each newly appearing displaying "+1 SPIN" in a free spin awards 1 additional free spin. GONG SPIN FEATURE ends after all awarded free spins have been played.

JACKPOT FEATURE



There is a chance that the JACKPOT FEATURE may be triggered when 1 or more appears in bought games only. In the JACKPOT FEATURE, select from 12 icons until 3 matching symbols corresponding to a JACKPOT level are revealed. When 3 matching JACKPOT level symbols have been revealed, the corresponding JACKPOT level is won and the JACKPOT FEATURE ends. The chances of revealing each jackpot symbol are not equal. A JACKPOT level is reset to its initial value each time that JACKPOT level is won. JACKPOT FEATURE and GONG SPIN FEATURE cannot be triggered in the same game.

TYPE OF FEATURES

Free Game + LP

REEL CONFIGURATION

5-Reel 3-Row Video Slot

PAYLINES

243 Ways

DENOMINATIONS

1c

BET CONFIGURATIONS

1, 2, 3, 4, 5, 6, 7, 8, 9, 10

MIN/MAX BET

88 up to 880

(Depends on the above Bet Configurations)



Fortunes abound with overflowing pots of gold coins in this exciting theme. With mystery symbols that randomly change and surprise bonuses, riches may be just one spin away. Special scatters add to the fun and can trigger even more free spins & prizes.

GONG SPIN FEATURE



3 scattered appearing on reels 2, 3 and 4 trigger the GONG SPIN FEATURE. When the GONG SPIN FEATURE is triggered, 3 free spins are awarded. Each newly appearing displaying "+1 SPIN" in a free spin awards 1 additional free spin. GONG SPIN FEATURE ends after all awarded free spins have been played.

JACKPOT FEATURE



There is a chance that the JACKPOT FEATURE may be triggered when 1 or more appears in bought games only. In the JACKPOT FEATURE, select from 12 icons until 3 matching symbols corresponding to a JACKPOT level are revealed. When 3 matching JACKPOT level symbols have been revealed, the corresponding JACKPOT level is won and the JACKPOT FEATURE ends. The chances of revealing each jackpot symbol are not equal. A JACKPOT level is reset to its initial value each time that JACKPOT level is won. JACKPOT FEATURE and GONG SPIN FEATURE cannot be triggered in the same game.



TYPE OF FEATURES

Free Game + LP

REEL CONFIGURATION

5-Reel 3-Row Video Slot

PAYLINES

243 Ways

DENOMINATIONS

1c

BET CONFIGURATIONS

1, 2, 3, 4, 5, 6, 7, 8, 9, 10

MIN/MAX BET

88 up to 880

(Depends on the above Bet Configurations)

FIRESTORM™ BULL

FIRESTORM™ LION



GONGGONG LAIFU™

CAISHEN RICHES

MIGHTY BUDDHA



GRAND JACKPOT
\$10,000.01

MEGA BONUS **\$1,000.00** MAJOR BONUS **\$500.00**
MINOR BONUS **\$100.00** MINT BONUS **\$60.00**

GONGGONG LAIFU™
CAISHEN RICHES

NO LIMITS
CREDIT 2000 BET 500 WIN 0

GRAND JACKPOT
\$10,000.01

MEGA BONUS **\$1,000.00** MAJOR BONUS **\$500.00**
MINOR BONUS **\$100.00** MINT BONUS **\$60.00**

GONGGONG LAIFU™
MIGHTY BUDDHA

NO LIMITS
CREDIT 2000 BET 500 WIN 0





The sound of the Gong brings good fortune. A new set of reels will appear during Gong Gong Lai Fu Feature, awarding Credit prizes or Bonuses. Each Gong symbol appearing is held for the entire Feature and adds to the prizes shown on top of the reels. Grand Jackpot can be won when all 15 Gong symbol are collected during Gong Gong Lai Fu Feature or as Jackpot Surprise during the bought games.

FREE GAMES FEATURE



Any 3 Gong symbols appearing on reels 2, 3 and 4 trigger the FREE GAMES FEATURE with 8 free games.

Reels used during the FREE GAMES FEATURE contain a greater total number of Gong symbols.

FREE GAMES FEATURE can be triggered again during the FREE GAMES FEATURE.

FREE GAMES FEATURE starts after the GONG GONG LAI FU FEATURE ends if triggered in the same game.

If GONG GONG LAI FU FEATURE is triggered during the FREE GAMES FEATURE, any remaining free games resume after the GONG GONG LAI FU FEATURE ends.

GONG GONG LAI FU FEATURE



Any 6 or more Gong symbols trigger the GONG GONG LAI FU FEATURE and are held in position on the reels for the duration of the GONG GONG LAI FU FEATURE.

GONG GONG LAI FU FEATURE consists of 3 free spins.

During the GONG GONG LAI FU FEATURE, each symbol position becomes an individual spinning bonus reel.

In the GONG GONG LAI FU FEATURE, a prize map corresponding to the 15 symbol positions on the reels is displayed above the reels. Before the first free spin, each Gong symbol on the reels displays the prize from the corresponding location on the prize map. While a Gong symbol is held on the reels, the prize in the corresponding location on the prize map is also held. At the start of each free spin in GONG GONG LAI FU FEATURE, displayed prizes are redetermined for prize map squares that do not contain a held prize. Each new Gong symbol appearing in a free spin displays a prize value that it is the sum of all held prizes displayed on the prize map from the previous free spin within the same GONG GONG LAI FU FEATURE only. Each new Gong symbol appearing in a free spin resets the number of remaining free spins to 3 and is held in position for the duration of the GONG GONG LAI FU FEATURE. GONG GONG LAI FU FEATURE ends after all awarded free spins have been played or if Gong symbols appear in all 15 symbol positions. All prizes on Gong symbols are won at the end of feature.

JACKPOT SURPRISE



There is a chance that the GRAND JACKPOT is randomly won in bought games except when FREE GAMES FEATURE or GONG GONG LAI FU FEATURE is triggered.

TYPE OF FEATURES

Free Game + LP

REEL CONFIGURATION

5-Reel 3-Row Video Slot

PAYLINES

10, 25, 50 Lines (Denomination 1, 2)
5, 10, 25 Lines (Denomination 3, 4, 5)
5 Lines (Denomination 6, 7, 8)

DENOMINATIONS

1	2	3	4	5	6	7	8
1c	2c	5c	10c	20c	\$1	\$2	\$5
5c	10c	25c	50c	\$1	\$5	\$10	\$25
10c	20c	50c	\$1	\$2	\$10	\$20	\$50
50c	\$1	\$2.50	\$5	\$10	\$50	\$100	\$250
\$1	\$2	\$5	\$10	\$20	\$100	\$200	\$500

BET CONFIGURATIONS

1, 2, 3, 4, 5
1, 2, 3, 5, 8
1, 2, 3, 5, 10
1, 2, 5, 10, 20

MAX BET

250, 400, 500, 1000 (Denomination 1, 2)
125, 200, 250, 500 (Denomination 3, 4, 5)
25, 40, 50, 100 (Denomination 6, 7, 8)



The sound of the Gong brings good fortune. A new set of reels will appear during Gong Gong Lai Fu Feature, awarding Credit prizes or Bonuses. Each Gong symbol appearing is held for the entire Feature and adds to the prizes shown on top of the reels. Grand Jackpot can be won when all 15 Gong symbol are collected during Gong Gong Lai Fu Feature or as Jackpot Surprise during the bought games.

FREE GAMES FEATURE



Any 3 appearing on reels 2, 3 and 4 trigger the FREE GAMES FEATURE with 6 free games.
 Reels used during the FREE GAMES FEATURE contain a greater total number of .
 FREE GAMES FEATURE can be triggered again during the FREE GAMES FEATURE.
 FREE GAMES FEATURE starts after the GONG GONG LAI FU FEATURE ends if triggered in the same game.
 If GONG GONG LAI FU FEATURE is triggered during the FREE GAMES FEATURE, any remaining free games resume after the GONG GONG LAI FU FEATURE ends.

GONG GONG LAI FU FEATURE



Any 6 or more trigger the GONG GONG LAI FU FEATURE and are held in position on the reels for the duration of the GONG GONG LAI FU FEATURE.
 GONG GONG LAI FU FEATURE consists of 3 free spins.
 During the GONG GONG LAI FU FEATURE, each symbol position becomes an individual spinning bonus reel.

In the GONG GONG LAI FU FEATURE, a prize map corresponding to the 15 symbol positions on the reels is displayed above the reels. Before the first free spin, each on the reels displays the prize from the corresponding location on the prize map. While a is held on the reels, the prize in the corresponding location on the prize map is also held. At the start of each free spin in GONG GONG LAI FU FEATURE, displayed prizes are redetermined for prize map squares that do not contain a held prize. Each new appearing in a free spin displays a prize value that it is the sum of all held prizes displayed on the prize map from the previous free spin within the same GONG GONG LAI FU FEATURE only. Each new appearing in a free spin resets the number of remaining free spins to 3 and is held in position for the duration of the GONG GONG LAI FU FEATURE. GONG GONG LAI FU FEATURE ends after all awarded free spins have been played or if appear in all 15 symbol positions. All prizes on Gong symbols are won at the end of feature.

JACKPOT SURPRISE



There is a chance that the GRAND JACKPOT is randomly won in bought games except when FREE GAMES FEATURE or GONG GONG LAI FU FEATURE is triggered.



TYPE OF FEATURES

Free Game + LP

REEL CONFIGURATION

5-Reel 3-Row Video Slot

PAYLINES

10, 25, 50 Lines (Denomination 1, 2)
 5, 10, 25 Lines (Denomination 3, 4, 5)
 5 Lines (Denomination 6, 7, 8)

DENOMINATIONS

1	2	3	4	5	6	7	8
1c	2c	5c	10c	20c	\$1	\$2	\$5
5c	10c	25c	50c	\$1	\$5	\$10	\$25
10c	20c	50c	\$1	\$2	\$10	\$20	\$50
50c	\$1	\$2.50	\$5	\$10	\$50	\$100	\$250
\$1	\$2	\$5	\$10	\$20	\$100	\$200	\$500

BET CONFIGURATIONS

1, 2, 3, 4, 5
 1, 2, 3, 5, 8
 1, 2, 3, 5, 10
 1, 2, 5, 10, 20

MAX BET

250, 400, 500, 1000 (Denomination 1, 2)
 125, 200, 250, 500 (Denomination 3, 4, 5)
 25, 40, 50, 100 (Denomination 6, 7, 8)

FU LAI CAI LAI 福来财来好运来 FORTUNE™

5 SEA LEGENDS™

TRIPLE FESTIVAL™

STACK WILD LUXURY™





Bold play opens the way to wild excitement and bigger wins. Increasing the bet level played improves several elements of gameplay, such as replacing a low paying symbol with a compounding triple-multiplier wild symbol on more and more reels, and unlocking a greater number of bonus and jackpot levels. Increasing credits bet per play makes a special payable available for the higher paying symbols. Free games can be retrIGGERED during the free games. Multiple jackpot chance features can be triggered and even mystery bonuses and jackpots can be won suddenly.

BET LEVEL (if available)	BECOMES ON THE REELS ACCORDING TO BET LEVEL PLAYED	JACKPOT AND BONUS LEVELS BECOME AVAILABLE ACCORDING TO BET LEVEL PLAYED
Play 88 credits	5 ON REELS 2, 3, 4 AND 5 ONLY	MAJOR JACKPOT - MINOR JACKPOT - WILD COIN BONUS - FREE GAMES
Play 66 credits	4 ON REELS 3, 4 AND 5 ONLY	MAJOR JACKPOT - MINOR JACKPOT - WILD COIN BONUS - FREE GAMES
Play 55 credits	3 ON REELS 4 AND 5 ONLY	MAJOR JACKPOT - MINOR JACKPOT - WILD COIN BONUS - FREE GAMES
Play 33 credits	2 ON REEL 5 ONLY	WILD COIN BONUS - FREE GAMES
Play 11 credits	NO REELS	NO JACKPOTS AVAILABLE

The JACKPOT FEATURE cannot be triggered and the WILD COIN BONUS cannot occur when playing bet level 1.

FREE GAMES FEATURE



🎰 appearing on 3 or more consecutive reels beginning with the leftmost reel trigger the FREE GAMES FEATURE with 8 FREE GAMES.

During FREE GAMES FEATURE, reels contains Picture symbol only.

FREE GAMES FEATURE can be triggered again during the FREE GAMES FEATURE.

JACKPOT FEATURE

There is a chance that 1 or more JACKPOT FEATURES are triggered when 1 or more 🎰 appear on the reels in a bought game or free game.



In the JACKPOT FEATURE, pick from 15 🎰 until 3 matching symbols corresponding to a PRIZE are revealed by picking 🎰 on the screen or by pressing the PLAY button which randomly picks a 🎰 with each press of the button. If 3 🎰 are revealed, an additional JACKPOT FEATURE is awarded and the feature continues until a PRIZE is won.

When 3 matching PRIZE have been revealed, the corresponding PRIZE is won and the JACKPOT FEATURE ends. Any additional JACKPOT FEATURE awarded, starts after the preceding JACKPOT FEATURE ends.

WILD COIN BONUS



There is a chance the WILD COIN BONUS may occur when 1 or more 🎰 appear on the reels in a bought game or free game. When the WILD COIN BONUS occurs, one of the following PRIZES as displayed on the game screen is won.

PRIZE AMOUNT: equal to the total credits bet multiplied by either 10, 20, 30, 50 or 100 randomly as displayed.

BONUS: MINI BONUS or MINOR BONUS (available according to bet level played)

JACKPOT: MAJOR JACKPOT or GRAND JACKPOT (available according to bet level played)

TYPE OF FEATURES

Free Game + LP

REEL CONFIGURATION

5-Reel 3-Row Video Slot

PAYLINES

243 Ways

DENOMINATIONS

1	2	3	4	5	6	7
1c	2c	5c	10c	20c	\$1	\$2
5c	10c	25c	50c	\$1	\$5	\$10
10c	20c	50c	\$1	\$2	\$10	\$20
50c	\$1	\$2.50	\$5	\$10	\$50	\$100
\$1	\$2	\$5	\$10	\$20	\$100	\$200

BET CONFIGURATIONS

1, 2, 3, 6, 10

MAX BET

880



Bold play opens the way to wild excitement and bigger wins. Increasing the bet level played improves several elements of gameplay, such as replacing a low paying symbol with stacks of wild symbols on more and more reels, and unlocking a greater number of bonus and jackpot levels. Increasing credits bet per play makes a special payable available for the higher paying symbols. During free games, one reel becomes wild each free spin. Multiple jackpot chance features can be triggered and even mystery bonuses and jackpots can be won suddenly.

BET LEVEL (if available)	BECOMES ON THE REELS ACCORDING TO BET LEVEL PLAYED	JACKPOT AND BONUS LEVELS BECOME AVAILABLE ACCORDING TO BET LEVEL PLAYED
Play 88 credits	5 ON REELS 2, 3, 4 AND 5 ONLY	MAJOR JACKPOT - GRAND JACKPOT - MINOR JACKPOT - MAJOR BONUS - MINOR BONUS
Play 66 credits	4 ON REELS 3, 4 AND 5 ONLY	MAJOR JACKPOT - MAJOR BONUS - MINOR BONUS
Play 55 credits	3 ON REELS 4 AND 5 ONLY	MAJOR JACKPOT - MAJOR BONUS
Play 33 credits	2 ON REEL 5 ONLY	MAJOR BONUS
Play 11 credits	1 NO REELS	NO JACKPOTS AVAILABLE

The JACKPOT FEATURE cannot be triggered and the WILD COIN BONUS cannot occur when playing bet level 1.

FREE GAMES FEATURE



appearing on 3 or more consecutive reels beginning with the leftmost reel trigger the FREE GAMES FEATURE with 8 FREE GAMES.

In each free game, all symbols on 1 reel (within reels 2, 3, 4 or 5 according to bet level played) randomly becomes .

FREE GAMES FEATURE cannot be triggered again during the FREE GAMES FEATURE.

JACKPOT FEATURE

There is a chance that 1 or more JACKPOT FEATURES are triggered when 1 or more appear on the reels in a bought game or free game.



In the JACKPOT FEATURE, pick from 15 until 3 matching symbols corresponding to a PRIZE are revealed by picking on the screen or by pressing the PLAY button which randomly picks a with each press of the button. If 3 are revealed, an additional JACKPOT FEATURE is awarded and the feature continues until a PRIZE is won.

When 3 matching PRIZE have been revealed, the corresponding PRIZE is won and the JACKPOT FEATURE ends. Any additional JACKPOT FEATURE awarded, starts after the preceding JACKPOT FEATURE ends.

WILD COIN BONUS



There is a chance the WILD COIN BONUS may occur when 1 or more appear on the reels in a bought game or free game. When the WILD COIN BONUS occurs, one of the following PRIZES as displayed on the game screen is won.

PRIZE AMOUNT: equal to the total credits bet multiplied by either 10, 20, 30, 50 or 100 randomly as displayed.

BONUS: MINI BONUS or MINOR BONUS (available according to bet level played)

JACKPOT: MAJOR JACKPOT or GRAND JACKPOT (available according to bet level played)



TYPE OF FEATURES

Free Game + LP

REEL CONFIGURATION

5-Reel 3-Row Video Slot

PAYLINES

243 Ways

DENOMINATIONS

1	2	3	4	5	6	7
1c	2c	5c	10c	20c	\$1	\$2
5c	10c	25c	50c	\$1	\$5	\$10
10c	20c	50c	\$1	\$2	\$10	\$20
50c	\$1	\$2.50	\$5	\$10	\$50	\$100
\$1	\$2	\$5	\$10	\$20	\$100	\$200

BET CONFIGURATIONS

1, 2, 3, 6, 10

MAX BET

880

GOD OF WINNING™

GREAT HAMMER

GOD OF WINNING™

SUPER SPEAR





Divine lightning storms of wild wins strike with enriching power. Three types of scatters leave behind a golden frame after they appear. These golden frames are resilient and held until they all become wild in a bought game. Trigger the free games feature with these golden frames in place and repeatedly reap the rewards as all held frames become wild during the feature. The excitement doesn't stop there, as all held frames that are in place at the start of the free games feature are still held after the feature ends. More winning energy is also on tap when the four-level progressive wheel randomly spins up a jackpot.

FREE GAMES FEATURE



There is a chance that FREE GAMES are triggered when 1 or more appear. FREE GAMES consists of 7 free games. Any held on the reels in the game that triggers the FREE GAMES become held for the duration of the FREE GAMES. There is a chance in each free game that 1 or more symbol positions that do not contain held randomly become for one spin only.

After the FREE GAMES end, all held that became during FREE GAMES become held again. FREE GAMES and JACKPOT WHEEL cannot be triggered in the same game.

JACKPOT WHEEL



There is a chance that the JACKPOT WHEEL is triggered when 1 or more appear. When the JACKPOT WHEEL is triggered, a wheel is displayed on the game screen and is spun once. After the wheel is spun, 1 wheel segment indicated by the pointer at the top of the wheel is selected.

The wheel contains the following:

JACKPOTS: GRAND, MAJOR, MINOR and MINI

Pressing the PLAY button or touching the game screen spins the wheel. JACKPOT WHEEL and FREE GAMES cannot be triggered in the same game. After a jackpot is won, the JACKPOT WHEEL ends.

WILD ZONE and WILD BONUS



There is a chance that WILD ZONE occurs for 3, 4 or 5 bought games, randomly. When WILD ZONE occurs, the reel frame takes on the following appearance for the duration of the WILD ZONE: . There is a chance that WILD CHANGE occurs in the WILD ZONE one time only. If WILD CHANGE occurs in the WILD ZONE, the WILD BONUS is triggered for up to 5 bought games, randomly. During each WILD BONUS game, appear on 8 or more random symbol positions that become on stopped reels for 1 spin only. If WILD BONUS is triggered, the WILD ZONE is extended until the WILD BONUS ends. All wins determined on stopped reels after the completion of symbol changes. After all wins are determined in each game of the WILD BONUS, any are removed.



TYPE OF FEATURES

Free Game + LP

REEL CONFIGURATION

5-Reel 4-Row Video Slot

PAYLINES

25 Lines

DENOMINATIONS

10c

BET CONFIGURATIONS

1, 2, 3, 4, 5, 6, 8, 10

MIN/MAX BET

75 Bet up to 750 Bet
(Depends on the above Bet Configurations)



Divine lightning storms of wild wins strike with enriching power. Three types of scatters leave behind a golden frame after they appear. These golden frames are resilient and held until they all become wild in a bought game. Trigger the free games feature with these golden frames in place and repeatedly reap the rewards as all held frames become wild during the feature. The excitement doesn't stop there, as all held frames that are in place at the start of the free games feature are still held after the feature ends. More winning energy is also on tap when the four-level progressive wheel randomly spins up a jackpot.

FREE GAMES FEATURE



There is a chance that FREE GAMES are triggered when 1 or more appear.

FREE GAMES consists of 7 free games.

Any held on the reels in the game that triggers the FREE GAMES become held for the duration of the FREE GAMES.

There is a chance in each free game that 1 or more symbol positions that do not contain held randomly become for one spin only.

After the FREE GAMES end, all held that became during FREE GAMES become held again. FREE GAMES and JACKPOT WHEEL cannot be triggered in the same game.

JACKPOT WHEEL



There is a chance that the JACKPOT WHEEL is triggered when 1 or more appear.

When the JACKPOT WHEEL is triggered, a wheel is displayed on the game screen and is spun once.

After the wheel is spun, 1 wheel segment indicated by the pointer at the top of the wheel is selected.

The wheel contains the following:

JACKPOTS: GRAND, MAJOR, MINOR and MINI

Pressing the PLAY button or touching the game screen spins the wheel. JACKPOT WHEEL and FREE GAMES cannot be triggered in the same game. After a jackpot is won, the JACKPOT WHEEL ends.

WILD ZONE AND WILD BONUS



There is a chance that WILD ZONE occurs for 3, 4 or 5 bought games, randomly. When WILD ZONE occurs, the reel frame takes on the following appearance for the duration of the WILD ZONE: .

There is a chance that WILD CHANGE occurs in the WILD ZONE one time only. If WILD CHANGE occurs in the WILD ZONE, the WILD BONUS is triggered for up to 5 bought games, randomly.

During each WILD BONUS game, appear on 8 or more random symbol positions that become on stopped reels for 1 spin only.

If WILD BONUS is triggered, the WILD ZONE is extended until the WILD BONUS ends. All wins determined on stopped reels after the completion of symbol changes. After all wins are determined in each game of the WILD BONUS, any are removed.

TYPE OF FEATURES

Free Game + LP

REEL CONFIGURATION

5-Reel 4-Row Video Slot

PAYLINES

25 Lines

DENOMINATIONS

1c

BET CONFIGURATIONS

1, 2, 3, 4, 5, 6, 8, 10

MIN/MAX BET

75 Bet up to 750 Bet

(Depends on the above Bet Configurations)

TRIPLE TREASURE POT™





Win big with an abundance of multiple features played at the same time. The three pots on screen represent bonus feature elements that can occur individually or combined in a single feature. Bonus feature elements consist of special credit prize symbols that nudge to fill their reels, special prize symbols awarding instant credit prizes and bonus/jackpot coins that are collected for big payouts, and expanding reels increasing the number of wins. There are also three randomly triggered prize actions that either instantly pay all displayed prizes on special symbols as shown, add on to prize values before there are paid, or multiplies prize values before they are paid.

TYPE OF FEATURES

Free Game + LP

REEL CONFIGURATION

5-Reel 4-Row Video Slot
5-Reel 6-Row (During the Ox Feature only)

PAYLINES

50 Lines
100 Lines (During the Ox Feature only)

DENOMINATIONS

1	2	3
1c	2c	5c
10c	20c	50c
\$1	\$2	\$5

BET CONFIGURATIONS

1, 2, 3, 6, 10

MAX BET

880

TIGER FEATURE



There is a chance that the TIGER FEATURE is triggered when 1 or more appear. TIGER FEATURE awards 5 free spins. Different reels are used during the TIGER FEATURE. Any reel with 1, 2 or 3 nudges to show 4 when any ACTION SYMBOL appears on reel 5. Line wins are determined only once before any reel nudge occurs. Prizes on are won only once after any reel nudge occurs. Any other FEATURE triggered during the TIGER FEATURE starts after the TIGER FEATURE ends, except ACTION PRIZES FEATURE.

DRAGON FEATURE



There is a chance that the DRAGON FEATURE is triggered when 1 or more appear. DRAGON FEATURE awards 10 free spins. Different reels are used during the DRAGON FEATURE. 1 of the following is displayed on each .

- CREDIT PRIZE: 100, 500 or 1000 credits multiplied by bet multiplier as displayed.
- MINI, MINOR, MAJOR or GRAND

Each CREDIT PRIZE displayed on is won. Each MINI, MINOR, MAJOR or GRAND displayed on is collected in its corresponding meter on the screen. Each appearing awards 1 additional free spin and up to 5 can be awarded only.

OX FEATURE



There is a chance that the OX FEATURE is triggered when 1 or more appear. OX FEATURE awards 5 free spins. Different reels are used during the OX FEATURE. Before the OX FEATURE starts, all reels are expanded upward 2 rows of symbols. Any other FEATURE triggered during the OX FEATURE starts after the OX FEATURE ends, except ACTION PRIZES FEATURE.

ACTION PRIZES FEATURE



Any combination of 1 or more and 1 ACTION SYMBOL trigger the corresponding ACTION PRIZE shown below.

ACTION SYMBOL	ACTION PRIZE
	Each prize displayed is won.
	Each prize displayed on is won after being increased by the credit value displayed on .
	Each displayed on is won after being multiplied by the multiplier displayed on .



Win big with an abundance of multiple features played at the same time. The three pots on screen represent bonus feature elements that can occur individually or combined in a single feature. Bonus feature elements consist of special credit prize symbols that nudge to fill their reels, special prize symbols awarding instant credit prizes and bonus/jackpot coins that are collected for big payouts, and expanding reels increasing the number of wins. There are also three randomly triggered prize actions that either instantly pay all displayed prizes on special symbols as shown, add on to prize values before there are paid, or multiplies prize values before they are paid.

TIGER FEATURE



There is a chance that the TIGER FEATURE is triggered when 1 or more appear. TIGER FEATURE awards 5 free spins. Any reel with 1, 2 or 3 nudges to show 4 when any ACTION SYMBOL appears on reel 5. Line wins are determined only once before any reel nudge occurs. Prizes on are won only once after any reel nudge occurs. Any other FEATURE triggered during the TIGER FEATURE starts after the TIGER FEATURE ends, except ACTION PRIZES FEATURE.

DRAGON FEATURE



There is a chance that the DRAGON FEATURE is triggered when 1 or more appear. DRAGON FEATURE awards 10 free spins. Each CREDIT PRIZE displayed on is won. Each MINI, MINOR, MAJOR or GRAND displayed on is collected in its corresponding meter on the screen. Each appearing awards 1 additional free spin and up to 5 can be awarded only.

OX FEATURE



There is a chance that the OX FEATURE is triggered when 1 or more appear. OX FEATURE awards 5 free spins. Before the OX FEATURE starts, all reels are expanded upward 2 rows of symbols. Any other FEATURE triggered during the OX FEATURE starts after the OX FEATURE ends, except ACTION PRIZES FEATURE.

ACTION PRIZES FEATURE



Any combination of 1 or more and 1 ACTION SYMBOL trigger the corresponding ACTION PRIZE shown below.

ACTION SYMBOL	ACTION PRIZE
	Each prize displayed is won.
	Each prize displayed on is won after being increased by the credit value displayed on .
	Each displayed on is won after being multiplied by the multiplier displayed on .



TYPE OF FEATURES

Free Game + LP

REEL CONFIGURATION

5-Reel 4-Row Video Slot
5-Reel 6-Row (During the Ox Feature only)

PAYLINES

50 Lines
100 Lines (During the Ox Feature only)

DENOMINATIONS

1	2	3
1c	2c	5c
10c	20c	50c
\$1	\$2	\$5

BET CONFIGURATIONS

1, 2, 3, 6, 10

MAX BET

880

LONGFUZHU™





Mighty dragon breathe fire to unlock superb win. Jackpot Feature randomly triggered in bought games. All prizes displayed on the orb symbols are held in the position for the duration of the DRAGON ORB FEATURE are won including bonus and jackpots. Reels used during the FREE GAMES FEATURE contain a greater total number of

FREE GAMES FEATURE



Any 3 appearing on reels 2, 3 and 4 trigger the FREE GAMES FEATURE with 6 free games. Reels used during the FREE GAMES FEATURE contain a greater total number of .

FREE GAMES FEATURE can be triggered again during the FREE GAMES FEATURE. FREE GAMES FEATURE starts after the DRAGON ORB FEATURE ends if triggered in the same game. If triggered in the same game, the FREE GAMES FEATURE starts after the DRAGON ORB FEATURE ends.

DRAGON ORB FEATURE



Any 6 or more appearing in a bought game or free game trigger the DRAGON ORB FEATURE. When DRAGON ORB FEATURE is triggered, 3 free spins are awarded. During the DRAGON ORB FEATURE, each symbol position becomes an individual spinning bonus reel.

Before the DRAGON ORB FEATURE starts, all reels are expanded upward 1 row of symbols and reel 5 is locked. At the start of DRAGON ORB FEATURE, only 6 appear on random symbol positions on reels 1, 2, 3 and 4 and are held in the position for the duration of the DRAGON ORB FEATURE. During the DRAGON ORB FEATURE, any newly appearing in a free spin resets the number of remaining free spins to 3 and are held in position until the DRAGON ORB FEATURE ends. When the reel 5 unlocks, it will spin automatically and each symbol position displayed 1 of the available prizes as shown below:

PRIZES	ACTION PRIZE
MULTIPLIER x2, x3 or x5	Each prize displayed on held appearing on the same row in which the MULTIPLIER appears is being multiplied by that MULTIPLIER.
PRIZE AMOUNT (50 LINES) each equal to 0, 40, 80, 100, 150, 200 or 250 credits multiplied by bet multiplier as displayed	Each prize displayed on held appearing on the same row in which the PRIZE AMOUNT appears is increased by that PRIZE AMOUNT.
PRIZE AMOUNT (25 LINES) each equal to 0, 20, 25, 40, 60, 75, 100 or 125 credits multiplied by bet multiplier as displayed	Each prize displayed on held appearing on the same row in which the PRIZE AMOUNT appears is increased by that PRIZE AMOUNT.
PRIZE AMOUNT (8 LINES) each equal to 5, 4, 5, 8, 10, 15, 20 or 25 credits multiplied by bet multiplier as displayed	Each prize displayed on held appearing on the same row in which the PRIZE AMOUNT appears is increased by that PRIZE AMOUNT.
BONUS KING'S BONUS or PRINCE'S BONUS	Each prize displayed on held appearing on the same row in which the BONUS appears is increased by that BONUS.

DRAGON ORB FEATURE ends after all awarded free spins have been played or if appear in all 16 symbol positions on reels 1, 2, 3 and 4.



MYSTERY JACKPOT AWARD

There is a chance that the GRAND JACKPOT is randomly won in bought games except when FREE GAMES FEATURE or DRAGON ORB FEATURE is triggered.



TYPE OF FEATURES

Free Game + LP

REEL CONFIGURATION

5-Reel 3-Row Video Slot

PAYLINES

50 Lines (Denomination 1, 2)
25 Lines (Denomination 3, 4, 5)
5 Lines (Denomination 6, 7, 8)

DENOMINATIONS

1	2	3	4	5	6	7	8
1c	2c	5c	10c	20c	\$1	\$2	\$5
5c	10c	25c	50c	\$1	\$5	\$10	\$25
10c	20c	50c	\$1	\$2	\$10	\$20	\$50
50c	\$1	\$2.50	\$5	\$10	\$50	\$100	\$250
\$1	\$2	\$5	\$10	\$20	\$100	\$200	\$500

BET CONFIGURATIONS

1, 2, 3, 4, 5
1, 2, 3, 5, 8
1, 2, 3, 5, 10
1, 2, 5, 10, 20

MAX BET

400, 640, 800, 1600 (Denomination 1, 2)
200, 320, 400, 800 (Denomination 3, 4, 5)
40, 64, 80, 160 (Denomination 6, 7, 8)



Mighty dragon breathe fire to unlock superb win. Jackpot Feature randomly triggered in bought games. All prizes displayed on the orb symbols are held in the position for the duration of the DRAGON ORB FEATURE are won including bonus and jackpots. During the FREE GAMES FEATURE, substituting in a win becomes .

FREE GAMES FEATURE



Any 3 appearing on reels 2, 3 and 4 trigger the FREE GAMES FEATURE with 6 free games. During the FREE GAMES FEATURE, substituting in a win becomes . The sum of multipliers from every that substitutes in a win multiplies the pay for that win. FREE GAMES FEATURE can be triggered again during the FREE GAMES FEATURE. FREE GAMES FEATURE starts after the DRAGON ORB FEATURE ends if triggered in the same game. If triggered in the same game, the FREE GAMES FEATURE starts after the DRAGON ORB FEATURE ends.

DRAGON ORB FEATURE



Any 6 or more appearing in a bought game or free game trigger the DRAGON ORB FEATURE. When DRAGON ORB FEATURE is triggered, 3 free spins are awarded. During the DRAGON ORB FEATURE, each symbol position becomes an individual spinning bonus reel.

Before the DRAGON ORB FEATURE starts, all reels are expanded upward 1 row of symbols and reel 5 is locked. At the start of DRAGON ORB FEATURE, only 6 appear on random symbol positions on reels 1, 2, 3 and 4 and are held in the position for the duration of the DRAGON ORB FEATURE. During the DRAGON ORB FEATURE, any newly appearing in a free spin resets the number of remaining free spins to 3 and are held in position until the DRAGON ORB FEATURE ends. When the reel 5 unlocks, it will spin automatically and each symbol position displayed 1 of the available prizes as shown below:

PRIZES	ACTION PRIZE
MULTIPLIER x2, x3 or x5	Each prize displayed on held appearing on the same row in which the MULTIPLIER appears is being multiplied by that MULTIPLIER.
PRIZE AMOUNT (30 LINES) each equal to 0, 40, 80, 90, 100, 150, 200 or 250 credits multiplied by bet multiplier as displayed	Each prize displayed on held appearing on the same row in which the PRIZE AMOUNT appears is increased by that PRIZE AMOUNT.
PRIZE AMOUNT (25 LINES) each equal to 0, 20, 25, 40, 50, 75, 100 or 125 credits multiplied by bet multiplier as displayed	Each prize displayed on held appearing on the same row in which the PRIZE AMOUNT appears is increased by that PRIZE AMOUNT.
PRIZE AMOUNT (8 lines) each equal to 0, 4, 6, 8, 10, 15, 20 or 25 credits multiplied by bet multiplier as displayed	Each prize displayed on held appearing on the same row in which the PRIZE AMOUNT appears is increased by that PRIZE AMOUNT.
BONUS MINI BONUS or MEGA BONUS	Each prize displayed on held appearing on the same row in which the BONUS appears is increased by that BONUS.

DRAGON ORB FEATURE ends after all awarded free spins have been played or if appear in all 16 symbol positions on reels 1, 2, 3 and 4.

TYPE OF FEATURES

Free Game + LP

REEL CONFIGURATION

5-Reel 3-Row Video Slot

PAYLINES

50 Lines (Denomination 1, 2)

25 Lines (Denomination 3, 4, 5)

5 Lines (Denomination 6, 7, 8)

DENOMINATIONS

1	2	3	4	5	6	7	8
1c	2c	5c	10c	20c	\$1	\$2	\$5
5c	10c	25c	50c	\$1	\$5	\$10	\$25
10c	20c	50c	\$1	\$2	\$10	\$20	\$50
50c	\$1	\$2.50	\$5	\$10	\$50	\$100	\$250
\$1	\$2	\$5	\$10	\$20	\$100	\$200	\$500

BET CONFIGURATIONS

1, 2, 3, 4, 5

1, 2, 3, 5, 8

1, 2, 3, 5, 10

1, 2, 5, 10, 20

MAX BET

400, 640, 800, 1600 (Denomination 1, 2)

200, 320, 400, 800 (Denomination 3, 4, 5)

40, 64, 80, 160 (Denomination 6, 7, 8)



MYSTERY JACKPOT AWARD

There is a chance that the GRAND JACKPOT is randomly won in bought games except when FREE GAMES FEATURE or DRAGON ORB FEATURE is triggered.

XINYUNQIU™

XINYUNQIU
DRAGON
GRAND
\$8,800.00
MAJOR
\$800.00

XINYUNQIU
LION
GRAND
\$8,800.00
MAJOR
\$800.00

MINOR \$25.02 MINI \$10.04

財

MULTIPLE WILDREEL

10	J	WILD	10	A
BONUS	10	J	9	

WIN 2000

MINOR \$25.00 MINI \$10.00

財

RANDOM MULTIPLE WILD

K	J	WILD	10	財
J	BONUS	10	K	FREE GAMES

WIN 2000





Thousands of coins on the orb that bring fortunes. Increased chance of big wins with wild symbol during the Wild Hold Spins. During each free game, all symbol positions on 1 or more reels randomly become / / or . Jackpot Feature randomly triggered in bought games. Additionally, a mystery credit prize may be randomly won in bought games.

TYPE OF FEATURES

Free Game + LP

REEL CONFIGURATION

5-Reel 3-4-4-4-3-Row Video Slot

PAYLINES

32 Lines

DENOMINATIONS

1c

BET CONFIGURATIONS

1, 2, 3, 4, 5, 6, 7, 8, 9, 10

MIN/MAX BET

88 Bet up to 880 Bet
(Depends on the above Bet Configurations)



WILD HOLD FEATURE

3 scattered appearing on reels 2, 3 and 4 trigger WILD HOLD FEATURE with 6 free spins.

Reels that triggered WILD HOLD FEATURE are held during the entirety of WILD HOLD FEATURE. Similarly, when WILD HOLD FEATURE triggered inside JACKPOT FEATURE, reels that triggered the JACKPOT FEATURE will use.

symbol change to WILD after reel stop are held until all free spins have been awarded.

The sum of multipliers from every / / / / that substitutes in a win multiplies the pay for that win. No wins for any combination during the free spins. All wins for WILD HOLD FEATURE are determined after the last free spin. However during JACKPOT FEATURE any coinciding win will be award first before proceeding to WILD HOLD FEATURE. WILD HOLD FEATURE start after the JACKPOT FEATURE ends if triggered in the same bought game.



FREE GAMES FEATURE

3 on reels 1, 3 and 5 trigger 7 FREE GAMES. FREE GAMES start after the JACKPOT FEATURE end if triggered in the same bought game. Bet Multiplier during the FREE GAME is same as the game that triggered the FREE GAME.

RANDOM WILD REEL

There is a chance that change to / / or after reel stop. The sum of multipliers from every / / / that substitutes in a win multiplies the pay for that win.



JACKPOT FEATURE

There is a chance that the JACKPOT FEATURE may be triggered when 1 or more appear in bought games only.

In the JACKPOT FEATURE, there are 4 types of jackpot and WILD HOLD BONUS symbols hidden behind 15 icons. Select an icon until 3 matching symbol corresponding to JACKPOT or WILD HOLD BONUS are revealed.

When 3 matching jackpot symbol has been revealed, the corresponding JACKPOT is won and JACKPOT FEATURE ends. However when 3 matching has been revealed, proceed to WILD HOLD FEATURE and JACKPOT FEATURE ends. The chances of revealing each jackpot or Bonus icons are not equal.



MYSTERY CREDIT AWARD

There is a chance that the MYSTERY CREDIT AWARD may occur in bought games only when is not stopped.

MYSTERY CREDIT AWARD is 15,000 credits, and multiplied by bet multiplier as displayed are awarded.



Thousands of coins on the orb that bring fortunes. Increased chance of big wins with wild symbol during the Wild Hold Spins. During each free game, all symbol positions on 1 or more reels randomly add **WILD**, **2X** or **3X** during spin. Jackpot Feature randomly triggered in bought games. Additionally, a mystery credit prize randomly won in bought games.



WILD HOLD FEATURE

3 scattered **BONUS** appearing on reels 2, 3 and 4 trigger WILD HOLD FEATURE with 6 free spins.

Reels that triggered WILD HOLD FEATURE are held during the entirety of WILD HOLD FEATURE. Similarly, when WILD HOLD FEATURE triggered inside JACKPOT FEATURE, reels that triggered the JACKPOT FEATURE will use.

BONUS symbol change to WILD after reel stop are held until all free spins have been awarded.

The sum of multipliers from every **2X** / **3X** / **4X** / **5X** / **6X** that substitutes in a win multiplies the pay for that win. No wins for any combination during the free spins. All wins for WILD HOLD FEATURE are determined after the last free spin. However during JACKPOT FEATURE any coinciding win will be award first before proceeding to WILD HOLD FEATURE. WILD HOLD FEATURE start after the JACKPOT FEATURE ends if triggered in the same bought game.



FREE GAMES FEATURE

3 **財** on reels 1, 3 and 5 trigger 7 FREE GAMES. FREE GAMES start after the JACKPOT FEATURE end if triggered in the same bought game. Bet Multiplier during the FREE GAME is same as the game that triggered the FREE GAME.

EXTRA RANDOM WILD

During reel spin, **WILD**, **2X** or **3X** may randomly add on the reel. The sum of multipliers from every **2X** / **3X** that substitutes in a win multiplies the pay for that win.



JACKPOT FEATURE

There is a chance that the JACKPOT FEATURE may be triggered when 1 or more **WILD** appear in bought games only. In the JACKPOT FEATURE, there are 4 types of jackpot and WILD HOLD BONUS symbols hidden behind 15 icons. When 3 matching jackpot symbol has been revealed, the corresponding JACKPOT is won and JACKPOT FEATURE ends. However when 3 matching **BONUS** has been revealed, proceed to WILD HOLD FEATURE and JACKPOT FEATURE ends. The chances of revealing each jackpot or Bonus icons are not equal.



MYSTERY CREDIT AWARD

There is a chance that the MYSTERY CREDIT AWARD may occur in bought games only when **WILD** is not stopped.

MYSTERY CREDIT AWARD is 15,000 credits, and multiplied by bet multiplier as displayed are awarded.



TYPE OF FEATURES

Free Game + LP

REEL CONFIGURATION

5-Reel 3-4-4-4-3-Row Video Slot

PAYLINES

32 Lines

DENOMINATIONS

1c

BET CONFIGURATIONS

1, 2, 3, 4, 5, 6, 7, 8, 9, 10

MIN/MAX BET

88 Bet up to 880 Bet
(Depends on the above Bet Configurations)

BINGO JACKPOT



12 BINGO JACKPOT \$5,000.00

10 BINGO BONUS	\$500.00
9 BINGO BONUS	\$250.00
8 BINGO BONUS	\$100.00
7 BINGO BONUS	\$50.00
6 BINGO BONUS	\$20.00
5 BINGO BONUS	\$10.00

LAS VEGAS

K	A	Q	300	60	J	K
J	180	K	K	K	K	K

1c 2000 60 0

12 BINGO JACKPOT \$5,000.00

10 BINGO BONUS	\$500.00
9 BINGO BONUS	\$250.00
8 BINGO BONUS	\$100.00
7 BINGO BONUS	\$50.00
6 BINGO BONUS	\$20.00
5 BINGO BONUS	\$10.00

NEW YORK

Q	A	A	K	K
J	300	A	10	10

1c 2000 60 0





Your conventional Bingo Game showcased with additional exciting features. Play and get a chance to win Multiple BINGO bonus win from 12 patterns of BINGO Win. Collect Prize Symbols and get a chance to Win Credit Prizes, Bonuses and Jackpots.

FREE GAMES FEATURE



Any 3 or more trigger FREE GAMES FEATURE with 6 free games.

Different reels are used during the FREE GAMES FEATURE. FREE GAMES FEATURE can be triggered again during the FREE GAMES FEATURE.

FREE GAMES FEATURE starts after COLLECT FEATURE or BINGO COLLECT FEATURE ends if triggered in the same game.

COLLECT FEATURE



In bought games and FREE GAMES FEATURE, 6 or more prize symbols trigger COLLECT FEATURE.

However when appears in center position of reel 3, all prize shown in the reel will be awarded first before COLLECT FEATURE start. Any prize symbols appearing in the game that trigger the COLLECT FEATURE are held in position for the duration of the COLLECT FEATURE.

Each symbol position becomes an individual spinning bonus reel during the COLLECT FEATURE.

When the COLLECT FEATURE is triggered, 3 free spins are awarded. Each newly appearing prize symbol in a free spin resets the number of remaining free spins to 3 and is held in position until the COLLECT FEATURE ends.

During the COLLECT FEATURE, when appears on the center position of reel 3 BINGO COLLECT FEATURE is triggered. COLLECT FEATURE ends after all awarded free spins have been played or if BINGO COLLECT FEATURE is triggered.

BINGO COLLECT FEATURE



During base game and FREE GAME FEATURE, 5 or more prize symbol with appears on the center position of reel 3 triggers BINGO COLLECT FEATURE.

All prize symbol appearing in the game that triggers the BINGO COLLECT FEATURE are held in position for the duration of the BINGO COLLECT FEATURE.

Any newly appearing prize symbol in a free spin resets the number of remaining free spins to 3 and is held in position until the BINGO COLLECT FEATURE ends.

When the BINGO COLLECT FEATURE is triggered, 3 free spins are awarded. All reels are expanded to 5 symbol positions during the BINGO COLLECT FEATURE.

Each symbol position becomes an individual spinning bonus reel during the BINGO COLLECT FEATURE.

BINGO LINE wins are only paid at the end of the BINGO COLLECT FEATURE, with the highest BINGO LINE wins paid only. BINGO COLLECT FEATURE ends after all awarded free spins have been played or if BINGO LINE 12 is formed.



TYPE OF FEATURES

Free Game + LP

REEL CONFIGURATION

5-Reel 3-Row Video Slot
(Up to 5-Reel 5-Rows during the Bingo Collect Feature)

PAYLINES

50 Lines

DENOMINATIONS

1c

BET CONFIGURATIONS

- 1, 2, 3, 4, 5
- 1, 2, 3, 4, 6
- 1, 2, 3, 4, 8
- 1, 2, 3, 5, 8
- 1, 2, 3, 5, 10
- 1, 2, 3, 6, 10

MAX BET

500, 600, 800, 1000



Your conventional Bingo Game showcased with additional exciting features. Play and get a chance to win Multiple BINGO bonus win from 12 patterns of BINGO Win. Collect Prize Symbols and get a chance to Win Credit Prizes, Bonuses and Jackpots.

FREE GAMES FEATURE



Any 3 or more  trigger FREE GAMES FEATURE with 6 free games.

Different reels are used during the FREE GAMES FEATURE. FREE GAMES FEATURE can be triggered again during the FREE GAMES FEATURE.

FREE GAMES FEATURE starts after COLLECT FEATURE or BINGO COLLECT FEATURE ends if triggered in the same game.

COLLECT FEATURE



In bought games and FREE GAMES FEATURE, 6 or more prize symbols trigger COLLECT FEATURE.

However when  appears in center position of reel 3, all prize shown in the reel will be awarded first before COLLECT FEATURE start. Any prize symbols appearing in the game that trigger the COLLECT FEATURE are held in position for the duration of the COLLECT FEATURE.

Each symbol position becomes an individual spinning bonus reel during the COLLECT FEATURE.

When the COLLECT FEATURE is triggered, 3 free spins are awarded. Each newly appearing prize symbol in a free spin resets the number of remaining free spins to 3 and is held in position until the COLLECT FEATURE ends.

During the COLLECT FEATURE, when  appears on the center position of reel 3 BINGO COLLECT FEATURE is triggered. COLLECT FEATURE ends after all awarded free spins have been played or if BINGO COLLECT FEATURE is triggered.

BINGO COLLECT FEATURE



During base game and FREE GAME FEATURE, 5 or more prize symbol with  appears on the center position of reel 3 triggers BINGO COLLECT FEATURE.

All prize symbol appearing in the game that triggers the BINGO COLLECT FEATURE are held in position for the duration of the BINGO COLLECT FEATURE.

Any newly appearing prize symbol in a free spin resets the number of remaining free spins to 3 and is held in position until the BINGO COLLECT FEATURE ends.

When the BINGO COLLECT FEATURE is triggered, 3 free spins are awarded. All reels are expanded to 5 symbol positions during the BINGO COLLECT FEATURE.

Each symbol position becomes an individual spinning bonus reel during the BINGO COLLECT FEATURE.

BINGO LINE wins are only paid at the end of the BINGO COLLECT FEATURE, with the highest BINGO LINE wins paid only. BINGO COLLECT FEATURE ends after all awarded free spins have been played or if BINGO LINE 12 is formed.

TYPE OF FEATURES

Free Game + LP

REEL CONFIGURATION

5-Reel 3-Row Video Slot
(Up to 5-Reel 5-Rows during the BINGO Collect Feature)

PAYLINES

50 Lines

DENOMINATIONS

1c

BET CONFIGURATIONS

- 1, 2, 3, 4, 5
- 1, 2, 3, 4, 6
- 1, 2, 3, 4, 8
- 1, 2, 3, 5, 8
- 1, 2, 3, 5, 10
- 1, 2, 3, 6, 10

MAX BET

500, 600, 800, 1000



MUSO™
TRIPLE-32HB

mu·so [mōō - sō] adj.
being the only one of its kind;
unlike anything else.



Stunning HD Graphics

Breathtakingly clear and bursting with rich colors displayed on three large 32-inch LCD monitor.



New Face Design

Equipped with Qi standard wireless charger. USB charging port also provided for player convenience.

A stunning new honeycomb cabinet LED display to attract players.

Thoughtful touches to keep them comfortable.

All designed for an unparalleled gaming experience.

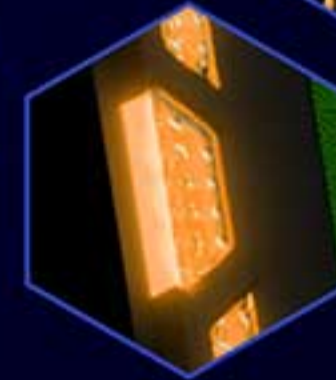

New honeycomb LED

Creating a unique visual experience not replicated in the market.



Ergonomic Button Deck

Inviting wrist rest and expansive glass table. Completely new interface design displayed on a 13.3-inch LCD deck.

DIMENSION

Upright Height (Tower Light Included)

93.1 in (2365 mm)

Upright Height (Tower Light Excluded)

89.4 in (2271 mm)

Width

31.9 in (810 mm)

Depth

27 in (685.4 mm)

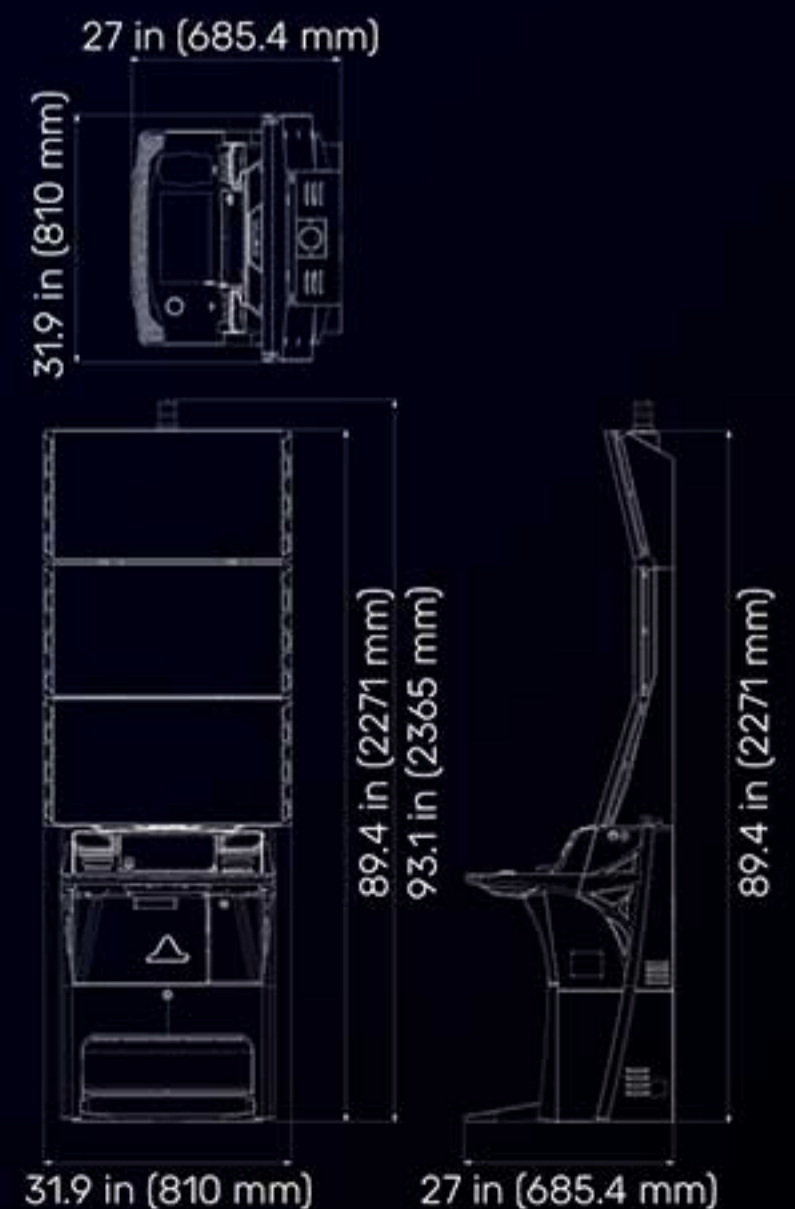

**BUILT FOR
EXCELLENCE**

BOMB

COLLECTOR™ GOLD HEIST

BOMB

COLLECTOR™ TREASURE HEIST

BOMB COLLECTOR GOLD HEIST

GRAND \$5,000.00

MAJOR \$500.00

REWARD \$25.00 **BONUS \$10.00**

▲ HOLD BOMB SPIN ▲
3 STACKED ◊ TRIGGER THE HOLD BOMB SPIN WITH 3 TYPES OF FEATURES AVAILABLE.

3 STACKED ◊ TRIGGER THE HOLD BOMB SPIN.

1c	CREDIT 2000	BET 375	WIN 0
----	-------------	---------	-------

BOMB COLLECTOR TREASURE HEIST

GRAND \$5,000.00

MAJOR \$500.01

REWARD \$25.02 **BONUS \$10.03**

▲ HOLD BOMB SPIN ▲
3 STACKED ◊ TRIGGER THE HOLD BOMB SPIN WITH 3 TYPES OF FEATURES AVAILABLE.

3 STACKED ◊ TRIGGER THE HOLD BOMB SPIN.

1c	CREDIT 2000	BET 375	WIN 0
----	-------------	---------	-------





Bomb explosions full of surprises. When bombs explode, they can trigger one of the explosive features: WILD BOOM, PRIZE BLAST, FREE GAMES EXPLOSION and JACKPOT FEATURE. More Jackpots can be also won when wild appears: GRAND, MAJOR, MINOR, MINI.

HOLD BOMB SPIN



1 free HOLD BOMB SPIN is triggered if 3 stacked appear on at least any one reel in bought games only. Any appearing in the bought game that triggers the HOLD BOMB SPIN or appearing in any additionally awarded free HOLD BOMB SPIN are held in position until the completion of the last HOLD BOMB SPIN. Each symbol position becomes an individual spinning bonus reel during HOLD BOMB SPIN. 1 additional free HOLD BOMB SPIN is awarded if any 1 or more new appear in any HOLD BOMB SPIN. If appears in all 15 symbol positions, no additional HOLD BOMB SPIN is awarded and the reels do not spin. HOLD BOMB SPIN starts after the JACKPOT FEATURE ends if triggered in the same bought game. After the last HOLD BOMB SPIN only, all held on the reels explode to award 1 of the following symbol change features: WILD BOOM, PRIZE BLAST or FREE GAMES EXPLOSION.

WILD BOOM



If WILD BOOM is awarded, each held explodes to become , or . If WILD BOOM is awarded, line wins are determined again and any resulting line wins are paid. The sum of the multipliers from every / that substitutes in a win multiplies the pay for that win.

PRIZE BLAST



If PRIZE BLAST is awarded, each held explodes to become awarding 1 of the following prizes: PRIZE AMOUNT: 20, 30, 40, 50, 60, 75, 100, 125, 150, 200, 250, 300, 400, 500, 750, 1000, 1500, 2000, 2500 or 3000 credits multiplied by bet multiplier as displayed.

JACKPOT: MINI, MINOR, MAJOR or GRAND (only 1 may display a JACKPOT).

If PRIZE BLAST is awarded, line wins are not determined again and therefore any line wins are not paid again.

FREE GAMES EXPLOSION



If FREE GAMES EXPLOSION is awarded, each held explodes to become awarding 1 of the following: 1, 2, 3, 4 or 5 free games. The sum of free games displayed on are awarded.

If FREE GAMES EXPLOSION is awarded, line wins are not determined again and therefore any line wins are not paid again.

Each free game, any appearing explodes to become awarding 1 of the following:

PRIZE AMOUNT: 20, 30, 40, 50, 75, 100, 125, 150, 200, 250, 300, 400, 500 or 750 credits multiplied by bet multiplier as displayed.

+1 SPIN: awards 1 additional free game.

Each free game, any appearing explodes to become awarding 1 of the following:

PRIZE AMOUNT: 100, 125, 150, 200, 250, 300, 400, 500, 750 or 1000 credits multiplied by bet multiplier as displayed.

+1 SPIN: awards 1 additional free game.

Each free game, any appearing explodes to become awarding 1 of the following:

PRIZE AMOUNT: 250, 300, 400, 500, 750, 1000, 1500, 2000, 2500 or 3000 credits multiplied by bet multiplier as displayed.

+1 SPIN: awards 1 additional free game Credits bet and lines played during the free games are the same as the game that triggered the free games.

JACKPOT FEATURE



There is a chance that the JACKPOT FEATURE may be triggered when 1 or more appear in bought games only. In the JACKPOT FEATURE, select from 12 icons until 3 matching symbols corresponding to a JACKPOT level are revealed.

When 3 matching JACKPOT level symbols have been revealed, the corresponding JACKPOT level is won and the JACKPOT FEATURE ends.



TYPE OF FEATURES

Free Game + LP

REEL CONFIGURATION

5-Reel 3-Row Video Slot

PAYLINES

30 Lines

DENOMINATIONS

1c

BET CONFIGURATIONS

1, 2, 3, 4, 5, 6, 7, 8, 9, 10

MIN/MAX BET

75 Bet up to 750 Bet

(Depends on the above Bet Configurations)



This bomb packs with full of surprises when explodes. When bomb explode it may awards one of the following prizes: WILD BOOM, PRIZE BLAST, FREE GAMES EXPLOSION and JACKPOT FEATURE. When wild appears it may also awards 1 of the Jackpots: GRAND, MAJOR, MINOR, MINI.

HOLD BOMB SPIN



HOLD BOMB SPIN are held in position until the completion of the last HOLD BOMB SPIN. Each symbol position becomes an individual spinning bonus reel during HOLD BOMB SPIN. 1 additional free HOLD BOMB SPIN is awarded if any 1 or more new appear in any HOLD BOMB SPIN. If appears in all 15 symbol positions, no additional HOLD BOMB SPIN is awarded and the reels do not spin. HOLD BOMB SPIN starts after the JACKPOT FEATURE ends if triggered in the same bought game. After the last HOLD BOMB SPIN only, all held on the reels explode to award 1 of the following symbol change features: WILD BOOM, PRIZE BLAST or FREE GAMES EXPLOSION.

1 free HOLD BOMB SPIN is triggered if 3 stacked appear on at least any one reel in bought games only. Any appearing in the bought game that triggers the HOLD BOMB SPIN or appearing in any additionally awarded free

WILD BOOM



If WILD BOOM is awarded, each held explodes to become or . If WILD BOOM is awarded, line wins are determined again and any resulting line wins are paid. The sum of the multipliers from every / that substitutes in a win multiplies the pay for that win.

PRIZE BLAST



If PRIZE BLAST is awarded, each held explodes to become awarding 1 of the following prizes: PRIZE AMOUNT: 20, 30, 40, 50, 60, 75, 100, 125, 150, 200, 250, 300, 400, 500, 750, 1000, 1500, 2000, 2500 or 3000 credits multiplied by bet multiplier as displayed.

JACKPOT: MINI, MINOR, MAJOR or GRAND (only 1 may display a JACKPOT).

If PRIZE BLAST is awarded, line wins are not determined again and therefore any line wins are not paid again.

FREE GAMES EXPLOSION



If FREE GAMES EXPLOSION is awarded, each held explodes to become awarding 1 of the following: 1, 2, 3, 4 or 5 free games. The sum of free games displayed on are awarded.

If FREE GAMES EXPLOSION is awarded, line wins are not determined again and therefore any line wins are not paid again.

Each free game, any appearing explodes to become awarding 1 of the following:

PRIZE AMOUNT: 20, 30, 40, 50, 75, 100, 125, 150, 200, 250, 300, 400, 500 or 750 credits multiplied by bet multiplier as displayed.

+1 SPIN: awards 1 additional free game.

Each free game, any appearing explodes to become awarding 1 of the following:

PRIZE AMOUNT: 100, 125, 150, 200, 250, 300, 400, 500, 750 or 1000 credits multiplied by bet multiplier as displayed.

+1 SPIN: awards 1 additional free game.

Each free game, any appearing explodes to become awarding 1 of the following:

PRIZE AMOUNT: 250, 300, 400, 500, 750, 1000, 1500, 2000, 2500 or 3000 credits multiplied by bet multiplier as displayed.

+1 SPIN: awards 1 additional free game Credits bet and lines played during the free games are the same as the game that triggered the free games.

JACKPOT FEATURE



There is a chance that the JACKPOT FEATURE may be triggered when 1 or more appear in bought games only. In the JACKPOT FEATURE, select from 12 icons until 3 matching symbols corresponding to a JACKPOT level are revealed.

When 3 matching JACKPOT level symbols have been revealed, the corresponding JACKPOT level is won and the JACKPOT FEATURE ends.

TYPE OF FEATURES

Free Game + LP

REEL CONFIGURATION

5-Reel 3-Row Video Slot

PAYLINES

30 Lines

DENOMINATIONS

1c

BET CONFIGURATIONS

1, 2, 3, 4, 5, 6, 7, 8, 9, 10

MIN/MAX BET

75 Bet up to 750 Bet

(Depends on the above Bet Configurations)

FORTUNE FRAME™

DRAGON BOUNTY

FORTUNE FRAME™

PANDA CARNIVAL

FORTUNE FRAME™
GRAND JACKPOT
\$10,000.01
MAJOR JACKPOT
\$501.95

FORTUNE FRAME™
GRAND JACKPOT
\$10,000.03
MAJOR JACKPOT
\$500.59

MINOR BONUS **\$25.00** MINI BONUS **\$10.00**
RANDOM MULTIPLYING WILD IN FREE GAMES

MINOR BONUS **\$25.00** MINI BONUS **\$10.00**
RANDOM WILD IN FREE GAMES

ANY 4 OR MORE TRIGGER CASH SPIN FEATURE!



CREDIT 2000 REEL 88 WIN 0

ANY 4 OR MORE TRIGGER CASH SPIN FEATURE!

CREDIT 2000 REEL 440 WIN 0







Collect more  for more prizes. Random  appearing in any symbol position boost your excitement. In Cash Spin, each spin awards prizes or an additional +1 spin. In Free Games, WILD randomly appear, becoming a multiplier and granting even bigger wins. GRAND JACKPOT or MAJOR JACKPOT can also be randomly won in bought games.



CASH SPIN



Any 6 or more  in a bought game trigger the CASH SPIN FEATURE.

When the CASH SPIN FEATURE is triggered, 5 free spins are awarded.

All  appearing in the game that triggers the CASH SPIN FEATURE become  that are held in position on the reels for the duration of the CASH SPIN FEATURE.

There is a chance in each free spin that 1  is added to a random symbol position that does not already contain a held  and is held in position until the CASH SPIN FEATURE ends.

Each spin, any prize appearing within a  is won.

CASH SPIN FEATURE starts after the FREE GAMES FEATURE ends if triggered in the same bought game.





CASH SPIN FEATURE ends after all awarded free spins have been played.

All  are removed when the CASH SPIN FEATURE ends.

FREE GAMES



Any 3  appearing on reels 2, 3 and 4 trigger the FREE GAMES FEATURE with 7 free games.

In each free game, there is a chance that one or more symbol positions randomly become , , ,  or .

The sum of multipliers from every , , ,  that substitutes in a win multiplies the pay for that win.

Any  appearing in the same position as , , , ,  is valid and displayed alternately if part of scatter win.

During the FREE GAMES FEATURE, any 3  appearing on reels 2, 3 and 4 awards 5 additional free games.

JACKPOT SURPRISE



There is a chance that 1 of the following prizes is randomly won in bought games except when FREE GAMES FEATURE or CASH SPIN FEATURE is triggered.

- GRAND JACKPOT
- MAJOR JACKPOT

TYPE OF FEATURES

Free Game + LP

REEL CONFIGURATION

5-Reel 3-Row Video Slot

PAYLINES

243 Ways

DENOMINATIONS

1	2	3	4	5	6
1c	2c	5c	10c	\$1	\$2
2c	5c	10c	20c	50c	\$1
5c	10c	20c	50c	\$1	\$2
5c	10c	20c	50c	\$1	\$10
10c	20c	50c	\$1	\$2	\$5
20c	50c	\$1	\$2	\$5	\$10
50c	\$1	\$2	\$5	\$10	\$20
\$1	\$2	\$5	\$10	\$20	\$50
\$2	\$5	\$10	\$20	\$100	\$200
\$10	\$20	\$50	\$100	\$500	\$1000

BET CONFIGURATIONS

1, 2, 3, 4, 5

1, 2, 3, 4, 6

1, 2, 3, 5, 10

1, 2, 3, 6, 10

1, 2, 5, 10, 20

MIN/MAX BET

8 Bet up to 1760 Bet

(Depends on the above Bet Configurations)



Collect more for more prizes. Random appearing in any symbol position boost your excitement. In Cash Spin, each spin awards prizes or an additional +1 spin. In Free Games, extra WILD appear granting even bigger wins. GRAND JACKPOT or MAJOR JACKPOT can also be randomly won in bought games.

CASH SPIN



Any 6 or more in a bought game trigger the CASH SPIN FEATURE.
 When the CASH SPIN FEATURE is triggered, 5 free spins are awarded.
 All appearing in the game that triggers the CASH SPIN FEATURE become that are held in position on the reels for the duration of the CASH SPIN FEATURE.
 There is a chance in each free spin that 1 is added to a random symbol position that does not already contain a held and is held in position until the CASH SPIN FEATURE ends.
 Each spin, any prize appearing within a is won.
 CASH SPIN FEATURE starts after the FREE GAMES FEATURE ends if triggered in the same bought game.
 CASH SPIN FEATURE ends after all awarded free spins have been played.
 All are removed when the CASH SPIN FEATURE ends.

FREE GAMES



Any 3 appearing on reels 2, 3 and 4 trigger the FREE GAMES FEATURE with 7 free games.
 In each free game, there is a chance that one or more symbol positions randomly become .
 Any appearing in the same position as is valid and displayed alternately if part of scatter win.
 During the FREE GAMES FEATURE, any 3 appearing on reels 2, 3 and 4 awards 5 additional free games.

JACKPOT SURPRISE



There is a chance that 1 of the following prizes is randomly won in bought games except when FREE GAMES FEATURE or CASH SPIN FEATURE is triggered.

- GRAND JACKPOT
- MAJOR JACKPOT



TYPE OF FEATURES

Free Game + LP

REEL CONFIGURATION

5-Reel 3-Row Video Slot

PAYLINES

243 Ways

DENOMINATIONS

1	2	3	4	5	6
1c	2c	5c	10c	\$1	\$2
2c	5c	10c	20c	50c	\$1
5c	10c	20c	50c	\$1	\$2
5c	10c	20c	50c	\$1	\$10
10c	20c	50c	\$1	\$2	\$5
20c	50c	\$1	\$2	\$5	\$10
50c	\$1	\$2	\$5	\$10	\$20
\$1	\$2	\$5	\$10	\$20	\$50
\$2	\$5	\$10	\$20	\$100	\$200
\$10	\$20	\$50	\$100	\$500	\$1000

BET CONFIGURATIONS

- 1, 2, 3, 4, 5
- 1, 2, 3, 4, 6
- 1, 2, 3, 5, 10
- 1, 2, 3, 6, 10
- 1, 2, 5, 10, 20

MIN/MAX BET

8 Bet up to 1760 Bet

(Depends on the above Bet Configurations)

DANCING PANDA SUPREME FESTIVAL

DANCING PANDA SUPREME FORTUNE





Happy blessings come from wild surprises. During free games, multiple symbol kinds on all reels may randomly become wild symbols and line wins may be multiplied by randomly appearing multiplier wild symbols. The all-new FUSION FEATURE may award multipliers on bonus symbols making all prizes be multiplied for extravagant amount of prizes.

FREE GAMES FEATURE



Any 3 or more trigger the FREE GAMES. FREE GAMES consist of 8 FREE GAMES.

During FREE GAMES, any 3 or more award 5 additional free games.

FREE GAMES start after the FUSION FEATURE ends if triggered in the same game. If the FUSION FEATURE is triggered during the FREE GAMES, any remaining free games resume after the FUSION FEATURE ends.

RANDOM WILD

There is a chance RANDOM WILD is triggered during the FREE GAMES only.

In the game that RANDOM WILD occurs, one or more symbol positions randomly become a substitute symbol as described in the sequence below.

- : If randomly appears in a symbol position.
- : If randomly appears in a symbol position that already randomly became .

If randomly appears in the same symbol position as a on a reel strip, only the randomly appearing is valid.

Every substituting in a win multiplies the pay for that win. Any scatter appearing in the same position as / is valid and displayed alternately if part of scatter win. In the spin that RANDOM WILD occurs, all wins are determined after all randomly selected symbol positions have become their determined symbol on stopped reels.

FUSION FEATURE



Any 6 or more in a bought game or a FREE GAME trigger the FUSION FEATURE.

When the FUSION FEATURE is triggered, 3 free spins are awarded.

Any appearing in the game that triggers the FUSION FEATURE become in the FUSION FEATURE.

Any symbol position or FUSION FEATURE REEL PATTERN during the FUSION FEATURE are held in position on the reels for the duration of the FUSION FEATURE. During the FUSION FEATURE free spins, each symbol position or FUSION FEATURE REEL PATTERN formed becomes an individual bonus reel. Any newly appearing in the FUSION FEATURE resets the number of remaining free spins to 3. FUSION FEATURE ends after all awarded free spins have been played or if all symbol positions are filled with / / .

JACKPOT SURPRISE



There is a chance that GRAND JACKPOT is randomly won in any bought game, except in the game that FUSION FEATURE is triggered.



TYPE OF FEATURES

Free Game + LP

REEL CONFIGURATION

5-Reel 3-Row Video Slot

PAYLINES

10, 20, 25, 30, 50 Lines (Denomination 1, 2)
5, 10, 15, 20, 25 Lines (Denomination 3, 4, 5)
1, 2, 3, 4, 5 Lines (Denomination 6, 7)

DENOMINATIONS

1	2	3	4	5	6	7
1c	2c	5c	10c	20c	\$1	\$2
5c	10c	25c	50c	\$1	\$5	\$10
10c	20c	50c	\$1	\$2	\$10	\$20
50c	\$1	\$2.50	\$5	\$10	\$50	\$100
\$1	\$2	\$5	\$10	\$20	\$100	\$200

BET CONFIGURATIONS

1, 2, 3, 4, 5
1, 2, 3, 5, 8
1, 2, 3, 5, 10
1, 2, 5, 10, 20

MAX BET

250, 400, 500, 1000 (Denomination 1, 2)
125, 200, 250, 500 (Denomination 3, 4, 5)
25, 40, 50, 100 (Denomination 6, 7)



Happy blessings come from wild surprises. During free games, multiple symbol kinds on all reels may randomly become wild symbols and line wins may be multiplied by randomly appearing multiplier wild symbols. The all-new FUSION FEATURE may award multipliers on bonus symbols making all prizes be multiplied for extravagant amount of prizes.

FREE GAMES FEATURE



Any 3 or more 🐼 trigger the FREE GAMES in bought games only. FREE GAMES consist of 7 FREE GAMES. During FREE GAMES, each 🐼 awards 1, 2 or 3 additional free games, randomly. FREE GAMES cannot be triggered again during the FREE GAMES. FREE GAMES start after the FUSION FEATURE ends if triggered in the same game. If the FUSION FEATURE is triggered during the FREE GAMES, any remaining free games resume after the FUSION FEATURE ends.

RANDOM WILD

There is a chance RANDOM WILD is triggered during the FREE GAMES only. In the game that RANDOM WILD occurs, one or more symbol positions randomly become a substitute symbol as described in the sequence below.

- 🐼: If 🐼 randomly appears in a symbol position.
- 🐼: If 🐼 randomly appears in a symbol position that already randomly became 🐼.

If 🐼 randomly appears in the same symbol position as a 🐼 on a reel strip, only the randomly appearing 🐼 is valid. Every 🐼 substituting in a win multiplies the pay for that win. Any scatter appearing in the same position as 🐼 / 🐼 is valid and displayed alternately if part of scatter win. RANDOM WILD and CHANGE UP cannot be triggered in the same free game. In the spin that RANDOM WILD occurs, all wins are determined after all randomly selected symbol positions have become their determined symbol on stopped reels.

CHANGE UP

There is a chance CHANGE UP is triggered during the FREE GAMES only. In the spin that CHANGE UP occurs, all A, K, Q, J and 10 on the reels change to 1 of the following symbols: 🐼, 🍜, 🍜, or 🍜. CHANGE UP and RANDOM WILD cannot be triggered in the same free game. In the spin that CHANGE UP occurs, all wins are determined after all symbols have changed to their determined symbol on stopped reels.

FUSION FEATURE



Any 6 or more 🍜 in a bought game or a FREE GAME trigger the FUSION FEATURE. When the FUSION FEATURE is triggered, 3 free spins are awarded. Any 🍜 appearing in the game that triggers the FUSION FEATURE become 🍜 in the FUSION FEATURE. Any 🍜 symbol position or FUSION FEATURE REEL PATTERN during the FUSION FEATURE are held in position on the reels for the duration of the FUSION FEATURE. During the FUSION FEATURE free spins, each symbol position or FUSION FEATURE REEL PATTERN formed becomes an individual bonus reel. Any newly appearing 🍜 in the FUSION FEATURE resets the number of remaining free spins to 3. FUSION FEATURE ends after all awarded free spins have been played or if all symbol positions are filled with 🍜 / 🍜 / 🍜.

JACKPOT SURPRISE



There is a chance that GRAND JACKPOT is randomly won in any bought game, except in the game that FUSION FEATURE is triggered.

TYPE OF FEATURES

Free Game + LP

REEL CONFIGURATION

5-Reel 3-Row Video Slot

PAYLINES

10, 20, 25, 30, 50 Lines (Denomination 1, 2)
5, 10, 15, 20, 25 Lines (Denomination 3, 4, 5)
1, 2, 3, 4, 5 Lines (Denomination 6, 7)

DENOMINATIONS

1	2	3	4	5	6	7
1c	2c	5c	10c	20c	\$1	\$2
5c	10c	25c	50c	\$1	\$5	\$10
10c	20c	50c	\$1	\$2	\$10	\$20
50c	\$1	\$2.50	\$5	\$10	\$50	\$100
\$1	\$2	\$5	\$10	\$20	\$100	\$200

BET CONFIGURATIONS

1, 2, 3, 4, 5
1, 2, 3, 5, 8
1, 2, 3, 5, 10
1, 2, 5, 10, 20

MAX BET

250, 400, 500, 1000 (Denomination 1, 2)
125, 200, 250, 500 (Denomination 3, 4, 5)
25, 40, 50, 100 (Denomination 6, 7)

TOMB TREASURE™





Dare to explore the hidden riches of lore. Win all prizes shown on collected bonus symbols and get extra free spins in any spin of the collect feature in which a new bonus symbol appears. Prizes on bonus symbols are determined by a changing prize map that mirrors the reels with each new bonus symbol displaying the sum of all prizes collected in previous spins. Grand Jackpot is won when 15 bonus symbols are collected or it is won randomly in bought games. Free games use reels with extra wild symbols.

FREE GAMES FEATURE



Any 3  appearing on reels 2, 3 and 4 trigger the FREE GAMES FEATURE with 8 free games.

Different reels are used during the FREE GAMES FEATURE.

Reels used during the FREE GAMES FEATURE contain a greater total number of .

FREE GAMES FEATURE can be triggered again during the FREE GAMES FEATURE.

FREE GAMES FEATURE starts after the PYRAMID FEATURE ends if triggered in the same game.

If PYRAMID FEATURE is triggered during the FREE GAMES FEATURE, any remaining free games resume after the PYRAMID FEATURE ends. Credits bet and lines played during the FREE GAMES FEATURE are the same as the game that triggered the FREE GAMES FEATURE.

PYRAMID FEATURE



Any 6 or more  trigger the PYRAMID FEATURE and are held in position on the reels for the duration of the PYRAMID FEATURE.

PYRAMID FEATURE consists of 3 free spins.

During the PYRAMID FEATURE, each symbol position becomes an individual spinning bonus reel.

In the PYRAMID FEATURE, a prize map corresponding to the 15 symbol positions on the reels is displayed above the reels. Each of the 15 squares in the prize map display one of the following available prizes.

PRIZE AMOUNT: each equal to 30, 40, 50, 80, 150, 250, 450 or 900 credits multiplied by bet multiplier as displayed.

BONUS: MINI BONUS, MINOR BONUS, MAJOR BONUS or MEGA BONUS

(BONUS values change according to wager amount as displayed)

JACKPOT SURPRISE



There is a chance that the GRAND JACKPOT is randomly won in bought games except when FREE GAMES FEATURE or PYRAMID FEATURE is triggered.

TYPE OF FEATURES

Free Game + LP

REEL CONFIGURATION

5-Reel 3-Row Video Slot

PAYLINES

- 10, 25, 50 Lines (Denomination 1, 2)
- 5, 10, 25 Lines (Denomination 3, 4, 5)
- 5 Lines (Denomination 6, 7, 8)

DENOMINATIONS

1	2	3	4	5	6	7	8
1c	2c	5c	10c	20c	\$1	\$2	\$5
5c	10c	25c	50c	\$1	\$5	\$10	\$25
10c	20c	50c	\$1	\$2	\$10	\$20	\$50
50c	\$1	\$2.50	\$5	\$10	\$50	\$100	\$250
\$1	\$2	\$5	\$10	\$20	\$100	\$200	\$500

BET CONFIGURATIONS

- 1, 2, 3, 4, 5
- 1, 2, 3, 5, 8
- 1, 2, 3, 5, 10
- 1, 2, 5, 10, 20

MAX BET

- 250, 400, 500, 1000 (Denomination 1, 2)
- 125, 200, 250, 500 (Denomination 3, 4, 5)
- 25, 40, 50, 100 (Denomination 6, 7, 8)



Dare to explore the hidden riches of lore. Win all prizes shown on collected bonus symbols and get extra free spins in any spin of the collect feature in which a new bonus symbol appears. Prizes on bonus symbols are determined by a changing prize map that mirrors the reels with each new bonus symbol displaying the sum of all prizes collected in previous spins. Grand Jackpot is won when 15 bonus symbols are collected or it is won randomly in bought games. Free games use reels with extra wild symbols.

FREE GAMES FEATURE



Any 3 appearing on reels 2, 3 and 4 trigger the FREE GAMES FEATURE with 6 free games.

Different reels are used during the FREE GAMES FEATURE.

Reels used during the FREE GAMES FEATURE contain a greater total number of .

FREE GAMES FEATURE can be triggered again during the FREE GAMES FEATURE.

FREE GAMES FEATURE starts after the PYRAMID FEATURE ends if triggered in the same game.

If PYRAMID FEATURE is triggered during the FREE GAMES FEATURE, any remaining free games resume after the PYRAMID FEATURE ends. Credits bet and lines played during the FREE GAMES FEATURE are the same as the game that triggered the FREE GAMES FEATURE.

PYRAMID FEATURE



Any 6 or more trigger the PYRAMID FEATURE and are held in position on the reels for the duration of the PYRAMID FEATURE.

PYRAMID FEATURE consists of 3 free spins.

During the PYRAMID FEATURE, each symbol position becomes an individual spinning bonus reel.

In the PYRAMID FEATURE, a prize map corresponding to the 15 symbol positions on the reels is displayed above the reels. Each of the 15 squares in the prize map display one of the following available prizes.

PRIZE AMOUNT: each equal to 30, 40, 50, 80, 150, 250, 450 or 900 credits multiplied by bet multiplier as displayed.

BONUS: MINI BONUS, MINOR BONUS, MAJOR BONUS or MEGA BONUS
(BONUS values change according to wager amount as displayed)

JACKPOT SURPRISE



There is a chance that the GRAND JACKPOT is randomly won in bought games except when FREE GAMES FEATURE or PYRAMID FEATURE is triggered.



TYPE OF FEATURES

Free Game + LP

REEL CONFIGURATION

5-Reel 3-Row Video Slot

PAYLINES

10, 25, 50 Lines (Denomination 1, 2)
5, 10, 25 Lines (Denomination 3, 4, 5)
5 Lines (Denomination 6, 7, 8)

DENOMINATIONS

1	2	3	4	5	6	7	8
1c	2c	5c	10c	20c	\$1	\$2	\$5
5c	10c	25c	50c	\$1	\$5	\$10	\$25
10c	20c	50c	\$1	\$2	\$10	\$20	\$50
50c	\$1	\$2.50	\$5	\$10	\$50	\$100	\$250
\$1	\$2	\$5	\$10	\$20	\$100	\$200	\$500

BET CONFIGURATIONS

1, 2, 3, 4, 5
1, 2, 3, 5, 8
1, 2, 3, 5, 10
1, 2, 5, 10, 20

MAX BET

250, 400, 500, 1000 (Denomination 1, 2)
125, 200, 250, 500 (Denomination 3, 4, 5)
25, 40, 50, 100 (Denomination 6, 7, 8)



Dare to explore the hidden riches of lore. Win all prizes shown on collected bonus symbols and get extra free spins in any spin of the collect feature in which a new bonus symbol appears. Prizes on bonus symbols are determined by a changing prize map that mirrors the reels with each new bonus symbol displaying the sum of all prizes collected in previous spins. Grand Jackpot is won when 15 bonus symbols are collected or it is won randomly in bought games. Free games use reels with extra wild symbols.

FREE GAMES FEATURE



Any 3 appearing on reels 2, 3 and 4 trigger the FREE GAMES FEATURE with 8 free games. Different reels are used during the FREE GAMES FEATURE. Reels used during the FREE GAMES FEATURE contain a greater total number of . FREE GAMES FEATURE can be triggered again during the FREE GAMES FEATURE. FREE GAMES FEATURE starts after the PYRAMID FEATURE ends if triggered in the same game. If PYRAMID FEATURE is triggered during the FREE GAMES FEATURE, any remaining free games resume after the PYRAMID FEATURE ends. Credits bet and lines played during the FREE GAMES FEATURE are the same as the game that triggered the FREE GAMES FEATURE.

PYRAMID FEATURE



Any 6 or more trigger the PYRAMID FEATURE and are held in position on the reels for the duration of the PYRAMID FEATURE. PYRAMID FEATURE consists of 3 free spins. During the PYRAMID FEATURE, each symbol position becomes an individual spinning bonus reel. In the PYRAMID FEATURE, a prize map corresponding to the 15 symbol positions on the reels is displayed above the reels. Each of the 15 squares in the prize map display one of the following available prizes.
PRIZE AMOUNT: each equal to 30, 40, 50, 80, 150, 250, 450 or 900 credits multiplied by bet multiplier as displayed.
BONUS: MINI BONUS, MINOR BONUS, MAJOR BONUS or MEGA BONUS
 (BONUS values change according to wager amount as displayed)

JACKPOT SURPRISE



There is a chance that the GRAND JACKPOT is randomly won in bought games except when FREE GAMES FEATURE or PYRAMID FEATURE is triggered.

TYPE OF FEATURES

Free Game + LP

REEL CONFIGURATION

5-Reel 3-Row Video Slot

PAYLINES

- 10, 25, 50 Lines (Denomination 1, 2)
- 5, 10, 25 Lines (Denomination 3, 4, 5)
- 5 Lines (Denomination 6, 7, 8)

DENOMINATIONS

1	2	3	4	5	6	7	8
1c	2c	5c	10c	20c	\$1	\$2	\$5
5c	10c	25c	50c	\$1	\$5	\$10	\$25
10c	20c	50c	\$1	\$2	\$10	\$20	\$50
50c	\$1	\$2.50	\$5	\$10	\$50	\$100	\$250
\$1	\$2	\$5	\$10	\$20	\$100	\$200	\$500

BET CONFIGURATIONS

- 1, 2, 3, 4, 5
- 1, 2, 3, 5, 8
- 1, 2, 3, 5, 10
- 1, 2, 5, 10, 20

MAX BET

- 250, 400, 500, 1000 (Denomination 1, 2)
- 125, 200, 250, 500 (Denomination 3, 4, 5)
- 25, 40, 50, 100 (Denomination 6, 7, 8)

HYPERSPEED

Entertainment has a classy new look.

Players can enjoy an exciting gaming experience.

Optimal service design for accessibility and maintenance.

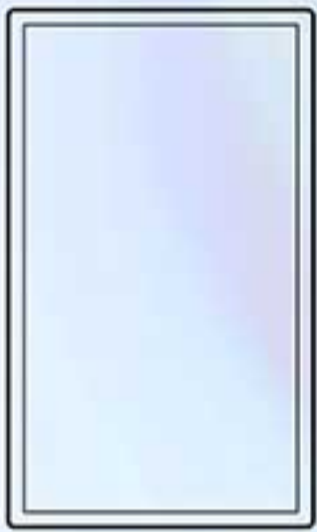

Stunning HD Graphics

An vertical LCD monitor with 43-inch LCD high definition monitor.



Immersive Audio

Newly designed sound system creates powerful theater-like sound.

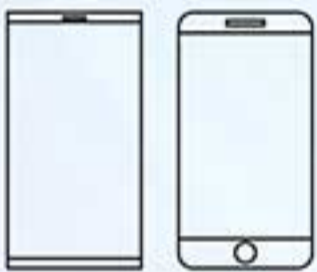

USB charging

USB charging port & wireless Charger also provided for player convenience.

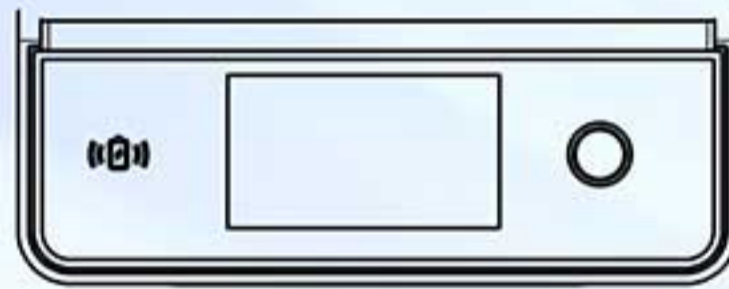

Ergonomic button deck

Premium Speed 11.6-inch LCD Touch Screen panel with Bash Button.



DIMENSION

(with Custom Stand Base version)

Upright Height

(Tower Light Included)
105.40 in (2677.1 mm)

Upright Height

(Tower Light Excluded)
101.34 in (2574.1 mm)

Width

26.77 in (680 mm)

Depth

24.85 in (631.1 mm)

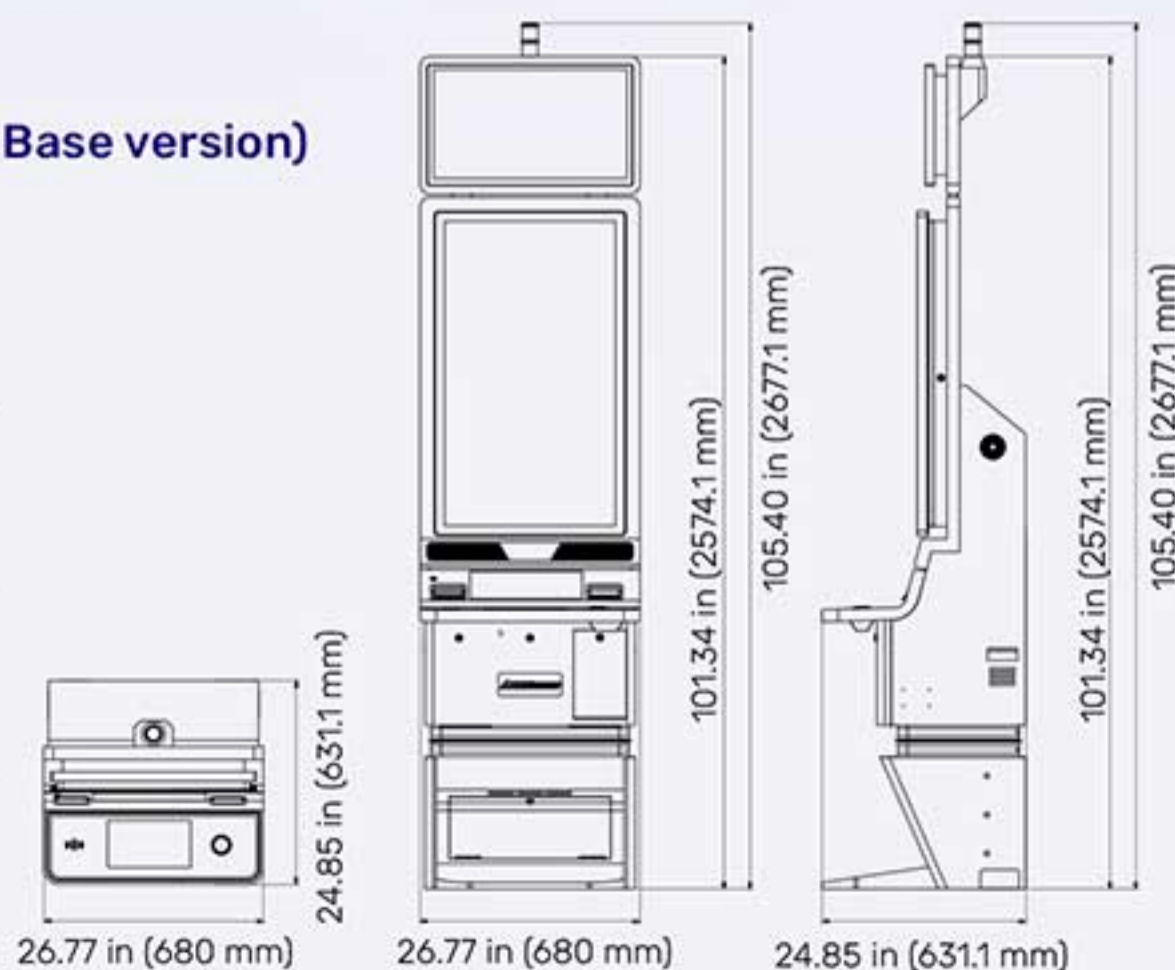

HYPERSPEED

Entertainment has a classy new look.

Players can enjoy an exciting gaming experience.

Optimal service design for accessibility and maintenance.

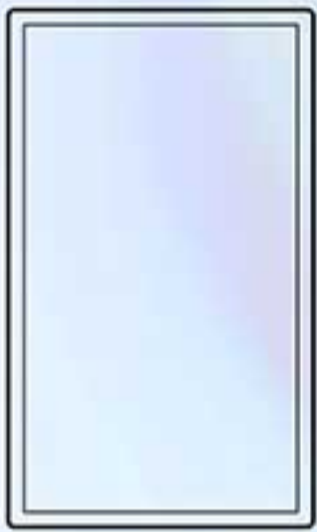

Stunning HD Graphics

An vertical LCD monitor with 43-inch LCD high definition monitor.

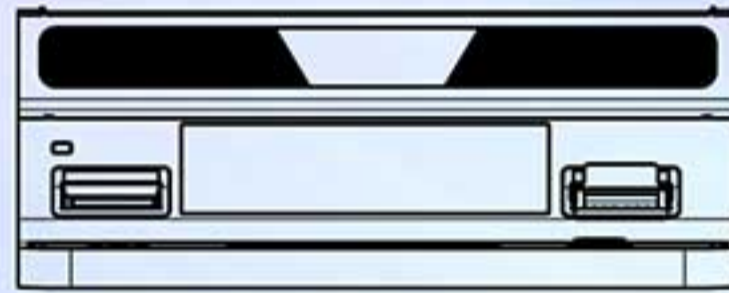

Immersive Audio

Newly designed sound system creates powerful theater-like sound.

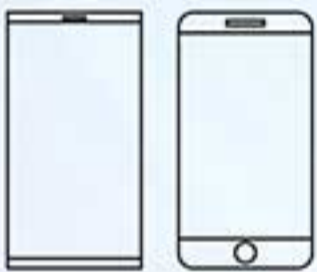

USB charging

USB charging port & wireless Charger also provided for player convenience.

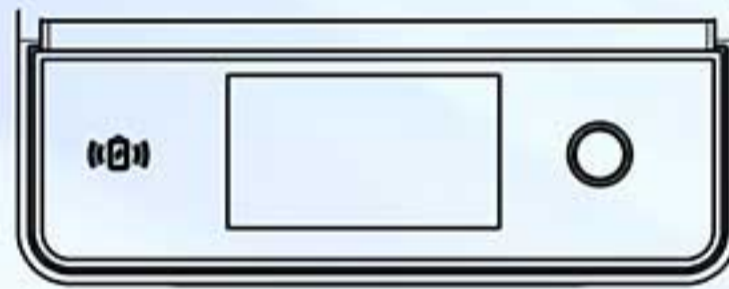

Ergonomic button deck

Premium Speed 11.6-inch LCD Touch Screen panel with Bash Button.



DIMENSION

(Upright version)

Upright Height
(Tower Light Included)
87.40 in (2219.9 mm)

Upright Height
(Tower Light Excluded)
83.34 in (2116.9 mm)

Width
26.77 in (680 mm)

Depth
24.85 in (631.1 mm)

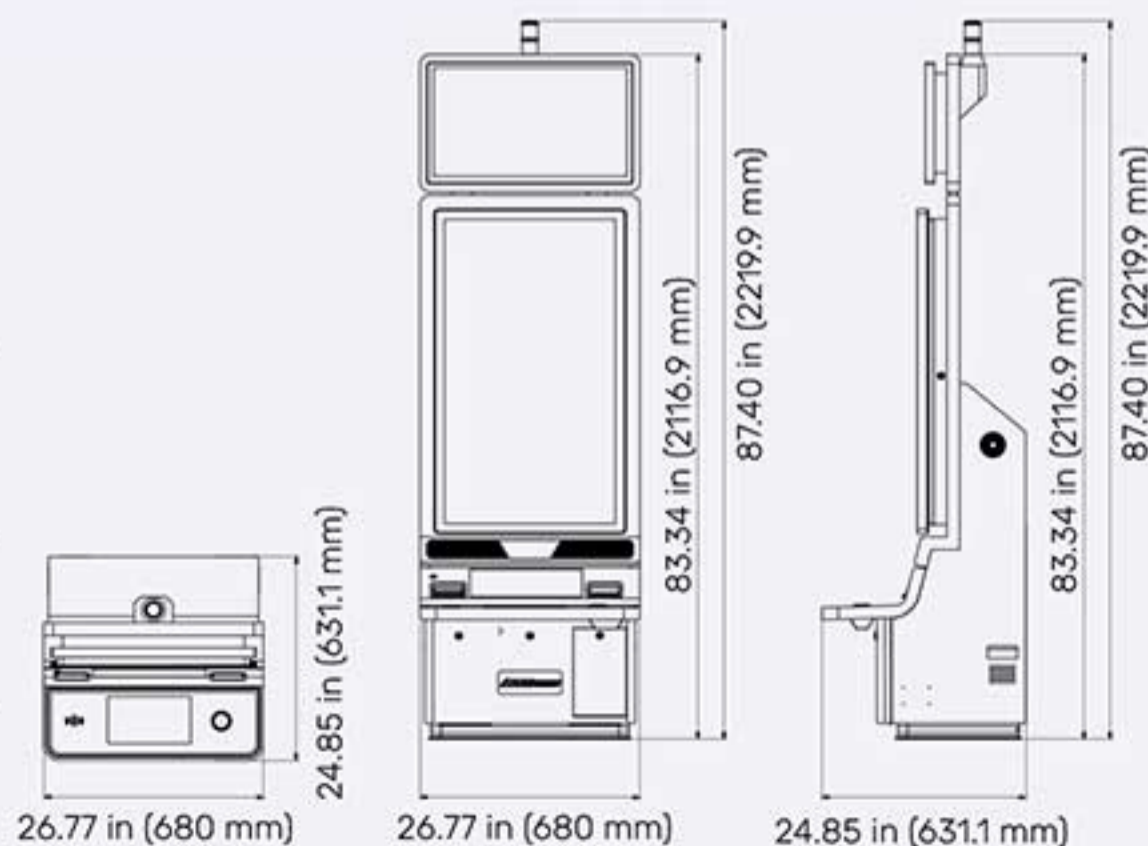

FU JIN SHU™

赋金树

GRAND
\$8,800.70

MAJOR
\$801.06

MINOR \$26.41 MINI \$12.83

GRAND
\$8,800.74

MAJOR
\$801.11

MINOR \$26.48 MINI \$12.96

FU JIN SHU™

赋金树

DRAGON

UP TO 4 EXTRA SYMBOL ROWS

EXTRA WILD IN FREE GAME

REELS

1c 1412 88 0

FU JIN SHU™

赋金树

PHOENIX

UP TO 4 EXTRA SYMBOL ROWS

EXTRA WILD IN FREE GAME

REELS

1c 1412 88 0

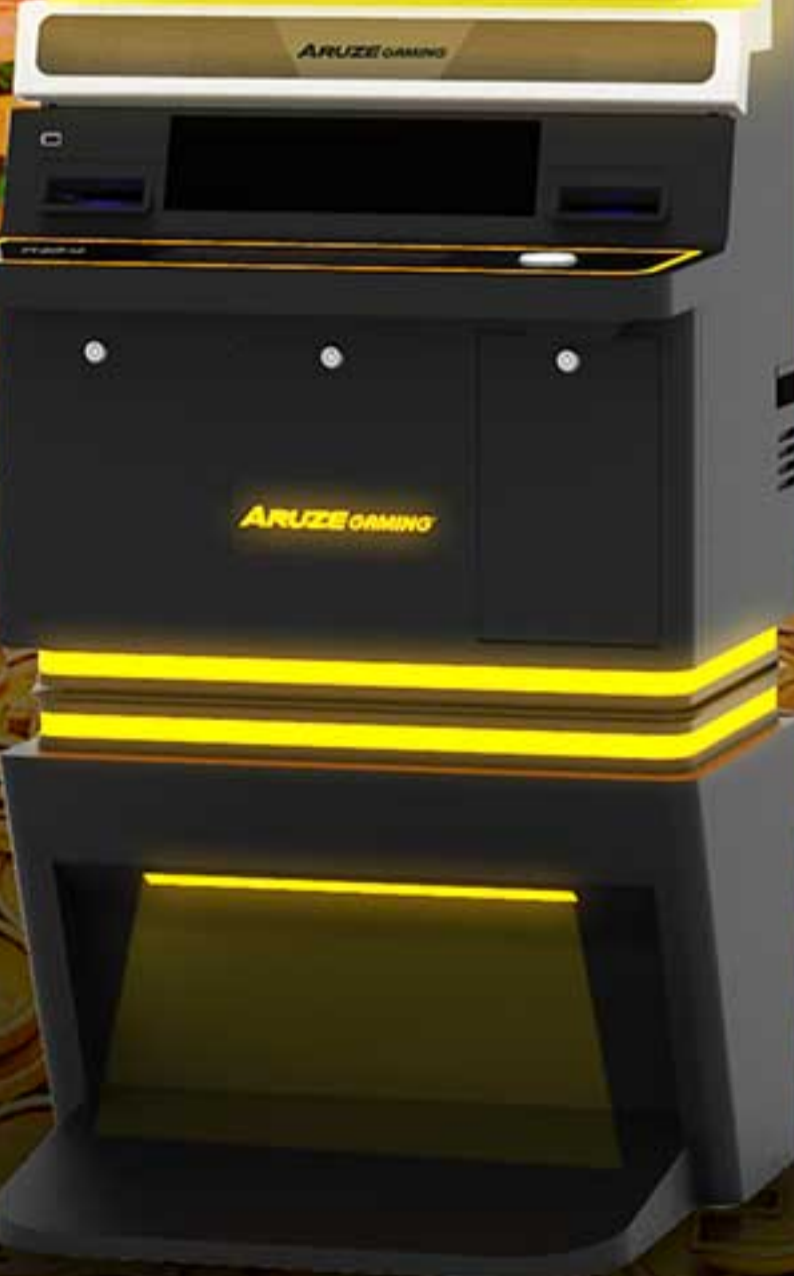



GRAND	
\$8,800.00	
MAJOR	
\$800.00	
MINOR	MINI
\$25.01	\$10.03



TYPE OF FEATURES

Free Game + LP

REEL CONFIGURATION

5-Reel 3-4-4-4-3-Row Video Slot
(EXPANDER REELS: Up to 7-8-8-8-7-Row)

PAYLINES

32 Lines (EXPANDER REELS: 80 Lines)

DENOMINATIONS

1c

BET CONFIGURATIONS

1, 2, 3, 4, 5, 6, 7, 8, 9, 10

MIN/MAX BET

88 Bet to 880 Bet

(Depends on the above Bet Configurations)



Thousands of coins flowering on the tree that sources jackpot wins. During bought games, the reels expand up to 4 extra symbol rows when bonus symbol appears on reels 2 and 3. Increased chance of big wins with wild symbol during the Wild Hold Spins. During each free game, the reels randomly expand up to 4 extra symbol rows and WILD may appear randomly across the reels. Jackpot Feature may be randomly triggered in bought games. Additionally, a mystery credit prize may be randomly won in bought games.

EXPANDER REELS

During bought games, 2 scattered appearing on reels 2 and 3 trigger EXPANDER REELS. During free games, EXPANDER REELS are randomly triggered. In the spin that EXPANDER REELS are triggered, all reels are expanded upward 1, 2, 3 or 4 rows of symbols, randomly.



FREE GAMES

3 scattered appearing on reels 1, 3 and 5 trigger 7 free games. Different reels are used during the free games.

EXTRA WILD

If EXPANDER REELS are triggered in a free game, there is a chance that one or more symbol positions randomly become , , or for that game. All wins determined after the completion of symbol changes has occurred. The sum of multipliers from every , , that substitutes in a win multiplies the pay for that win. Free games start after the JACKPOT FEATURE ends if triggered in the same bought game.

WILD HOLD SPINS

3 scattered appearing on reels 2, 3 and 4 trigger 6 free spins of overlaying reels containing while the reels of the bought game are held. All payable wins for the bought game are determined after the last free spin. When a stops on a symbol position, that symbol position becomes a substitute symbol as described below and is held in position until all wins for the bought game are determined after the last free spin. No wins for any combination during the free spins.



- : If stops on any symbol position.
- : If stops on a symbol position that became .
- : If stops on a symbol position that became .
- : If stops on a symbol position that became .
- : If stops on a symbol position that became .
- : If stops on a symbol position that became .

The sum of multipliers from every , , , , that substitutes in a win multiplies the pay for that win. The row height of the overlay reels used during the free spins are the same as the row height of the reels used in the game that

triggered the free spins. WILD HOLD SPINS start after the JACKPOT FEATURE ends if triggered in the same bought game.



JACKPOT FEATURE

There is a chance that the JACKPOT FEATURE may be triggered when 1 or more appear on reels 2, 3 or 4 in bought games only. on any reel in a bought game that is a result of WILD HOLD SPINS does not offer a chance to trigger the JACKPOT FEATURE. In the JACKPOT FEATURE, there are 4 types of jackpot symbols hidden behind 12 icons. Select an icon until 3 matching jackpot symbols corresponding to a JACKPOT are revealed. When 3 matching jackpot symbols have been revealed, the corresponding JACKPOT is won and the JACKPOT FEATURE ends. JACKPOT FEATURE and BONUS SURPRISE cannot be triggered in the same game.

BONUS SURPRISE

There is a chance that the BONUS SURPRISE may be triggered when 1 or more appear on reels 2, 3 or 4 in bought games only. on any reel in a bought game that is a result of WILD HOLD SPINS does not offer a chance to trigger the BONUS SURPRISE. When the BONUS SURPRISE occurs, 10000 credits multiplied by bet multiplier as displayed are awarded. BONUS SURPRISE and JACKPOT FEATURE cannot be triggered in the same game. Any BONUS SURPRISE win is added to line wins.



Thousands of coins flowering on the tree that sources jackpot wins. During bought games, the reels expand up to 4 extra symbol rows when bonus symbol appears on reels 2 and 3. Increased chance of big wins with wild symbol during the Wild Hold Spins. During each free game, the reels randomly expand up to 4 extra symbol rows and all symbol positions on 1 or more reels become **WILD** or **2x**. Jackpot Feature may be randomly triggered in bought games. Additionally, a mystery credit prize may be randomly won in bought games.

EXPANDER REELS

During bought games, 2 scattered appearing on reels 2 and 3 trigger EXPANDER REELS. During free games, EXPANDER REELS are randomly triggered. In the spin that EXPANDER REELS are triggered, all reels are expanded upward 1, 2, 3 or 4 rows of symbols, randomly.



FREE GAMES

3 scattered appearing on reels 1, 3 and 5 trigger 7 free games. Different reels are used during the free games.

REELS WILD

If EXPANDER REELS are triggered in a free game, there is a chance that all symbol positions on 2 or 3 reels become either **WILD** or **2x** in that game. All wins determined after the completion of symbol changes has occurred. The sum of multipliers from every **2x** that substitutes in a win multiplies the pay for that win. Free games start after the JACKPOT FEATURE ends if triggered in the same bought game.

WILD HOLD SPINS

3 scattered appearing on reels 2, 3 and 4 trigger 6 free spins of overlaying reels containing while the reels of the bought game are held. All payable wins for the bought game are determined after the last free spin. When a stops on a symbol position, that symbol position becomes a substitute symbol as described below and is held in position until all wins for the bought game are determined after the last free spin. No wins for any combination during the free spins.



- WILD**: If stops on any symbol position.
- 2x**: If stops on a symbol position that became **WILD**.
- 3x**: If stops on a symbol position that became **2x**.
- 4x**: If stops on a symbol position that became **3x**.
- 5x**: If stops on a symbol position that became **4x**.
- 6x**: If stops on a symbol position that became **5x**.

The sum of multipliers from every **2x/3x/4x/5x/6x** that substitutes in a win multiplies the pay for that win. The row height of the overlay reels used during the free spins are the same as the row height of the reels used in the game that

triggered the free spins. WILD HOLD SPINS start after the JACKPOT FEATURE ends if triggered in the same bought game.



JACKPOT FEATURE

There is a chance that the JACKPOT FEATURE may be triggered when 1 or more **WILD** appear on reels 2, 3 or 4 in bought games only. **WILD** on any reel in a bought game that is a result of WILD HOLD SPINS does not offer a chance to trigger the JACKPOT FEATURE. In the JACKPOT FEATURE, there are 4 types of jackpot symbols hidden behind 12 icons. Select an icon until 3 matching jackpot symbols corresponding to a JACKPOT are revealed. When 3 matching jackpot symbols have been revealed, the corresponding JACKPOT is won and the JACKPOT FEATURE ends. JACKPOT FEATURE and BONUS SURPRISE cannot be triggered in the same game.

BONUS SURPRISE

There is a chance that the BONUS SURPRISE may be triggered when 1 or more **WILD** appear on reels 2, 3 or 4 in bought games only. **WILD** on any reel in a bought game that is a result of WILD HOLD SPINS does not offer a chance to trigger the BONUS SURPRISE. When the BONUS SURPRISE occurs, 10000 credits multiplied by bet multiplier as displayed are awarded. BONUS SURPRISE and JACKPOT FEATURE cannot be triggered in the same game. Any BONUS SURPRISE win is added to line wins.



TYPE OF FEATURES

Free Game + LP

REEL CONFIGURATION

5-Reel 3-4-4-4-3-Row Video Slot
(EXPANDER REELS: Up to 7-8-8-8-7-Row)

PAYLINES

32 Lines (EXPANDER REELS: 80 Lines)

DENOMINATIONS

1c

BET CONFIGURATIONS

1, 2, 3, 4, 5, 6, 7, 8, 9, 10

MIN/MAX BET

88 Bet to 880 Bet

(Depends on the above Bet Configurations)

CAT YUN LAI™ 财运来





Wealth and luck are flowing from the pot of coins. During bought games and free games, all reels contain mystery symbol positions that randomly become the same symbol at the start of each spin. During the free games, 3 exciting free game options allow players to select the volatility of the feature. Additionally, every multiplier on WILD substituting in a win multiplies the pay for that win. JACKPOT FEATURE may be randomly triggered in bought games and free games. A mystery credit prize may also be randomly won in bought games and free games.

FREE GAMES



appearing on 3 or more consecutive reels beginning with the leftmost reel trigger the free games. Different reels are used during the free games. Before free games start, select 1 of 3 free game options to play.



Every multiplier on substituting in a win multiplies the pay for that win. During the free games, appearing on 2 or more consecutive reels beginning with the leftmost reel award 3 additional free games. Free games start after the JACKPOT FEATURE ends if triggered in the same game. If JACKPOT FEATURE is triggered during free games, any remaining free games resume after JACKPOT FEATURE ends. Credits bet, GOLD PAYS and ways played during the free games are the same as the game that triggered the free games.

JACKPOT FEATURE

There is a chance that the JACKPOT FEATURE may be triggered when 1 or more appears.



In the JACKPOT FEATURE, select from 12 icons until 3 matching symbols corresponding to a JACKPOT level are revealed.

When 3 matching JACKPOT level symbols have been revealed, the corresponding JACKPOT level is won and the JACKPOT FEATURE ends.

JACKPOT levels available according to GOLD PAYS played. The chances of revealing each jackpot symbol are not equal.

JACKPOT FEATURE and BONUS SURPRISE cannot be triggered in the same game.

BONUS SURPRISE



There is a chance that the BONUS SURPRISE may be triggered when 1 or more appears.

When the BONUS SURPRISE occurs, 250000 credits are awarded.

BONUS SURPRISE and JACKPOT FEATURE cannot be triggered in the same game.

Any BONUS SURPRISE win is added to line wins.



TYPE OF FEATURES

Free Game + LP

REEL CONFIGURATION

5-Reel 3-4-4-4-3-Row Video Slot

PAYLINES

576 Ways

DENOMINATIONS

1c

BET CONFIGURATIONS

1, 2, 3, 4, 5, 6, 7, 8, 9, 10

MIN/MAX BET

18 up to 880

(Depends on the above Bet Configurations)



Wealth and luck are flowing from the pot of coins. During bought games and free games, all reels contain mystery symbol positions that randomly become the same symbol at the start of each spin. During the free games, 4 exciting free game options allow players to select the volatility of the feature. JACKPOT FEATURE may be randomly triggered in bought games and free games. A mystery credit prize may also be randomly won in bought games and free games.

FREE GAMES



appearing on 3 or more consecutive reels beginning with the leftmost reel trigger the free games. Different reels are used during the free games. Before free games start, select 1 of 4 free game options to play.



During the free games, appearing on 2 or more consecutive reels beginning with the leftmost reel award 3 additional free games within the free game option being played. Free games start after the JACKPOT FEATURE ends if triggered in the same game. If JACKPOT FEATURE is triggered during free games, any remaining free games resume after JACKPOT FEATURE ends. Credits bet and GOLD PAYS played during the free games are the same as the game that triggered the free games.

JACKPOT FEATURE

There is a chance that the JACKPOT FEATURE may be triggered when 1 or more appears.



In the JACKPOT FEATURE, select from 12 icons until 3 matching symbols corresponding to a JACKPOT level are revealed.

When 3 matching JACKPOT level symbols have been revealed, the corresponding JACKPOT level is won and the JACKPOT FEATURE ends.

JACKPOT levels available according to GOLD PAYS played. The chances of revealing each jackpot symbol are not equal.

JACKPOT FEATURE and BONUS SURPRISE cannot be triggered in the same game.

BONUS SURPRISE



There is a chance that the BONUS SURPRISE may be triggered when 1 or more appears.

When the BONUS SURPRISE occurs, 250000 credits are awarded.

BONUS SURPRISE and JACKPOT FEATURE cannot be triggered in the same game.

Any BONUS SURPRISE win is added to line wins.

TYPE OF FEATURES

Free Game + LP

REEL CONFIGURATION

5-Reel 3-4-4-4-3-Row Video Slot
(Up to 6-7-7-7-6-Row during the free games)

PAYLINES

576 Ways

DENOMINATIONS

1c

BET CONFIGURATIONS

1, 2, 3, 4, 5, 6, 7, 8, 9, 10

MIN/MAX BET

18 up to 880

(Depends on the above Bet Configurations)



Wealth and luck are flowing from the pot of coins. During bought games and free games, all reels contain mystery symbol positions that randomly become the same symbol at the start of each spin. During each free game, from 2 to 12 randomly determined symbol positions become WILD. JACKPOT FEATURE may be randomly triggered in bought games and free games. A mystery credit prize may also be randomly won in bought games and free games.

FREE GAMES



appearing on 3 or more consecutive reels beginning with the leftmost reel trigger 6 free games. Different reels are used during the free games. At the start of each free game, randomly determined symbol positions on 2 to 4 reels become for that free game only. The number of positions that can randomly become corresponds to the GOLD PAYS played, the number of reels that random appears on and the reel number as described below.

GOLD PAYS	RANDOM APPEARING ON TWO REELS					RANDOM APPEARING ON THREE REELS					RANDOM APPEARING ON FOUR REELS				
	1	2	3	4	5	1	2	3	4	5	1	2	3	4	5
MAX GOLD PAYS	3	4	4	4	3	2	3	3	3	2	3	3	3	3	3
GOLD PAYS 4	3	4	4	4	3	2	3	3	3	2	3	3	3	3	3
GOLD PAYS 3	2	2	2	2	3	2	3	3	3	2	2	3	3	3	3
GOLD PAYS 2	2	2	2	2	3	2	3	3	3	2	2	3	3	3	3

All wins determined on stopped reels after the completion of all symbol changes. Free games cannot be triggered again during the free games. Free games start after the JACKPOT FEATURE ends if triggered in the same bought game. If JACKPOT FEATURE is triggered during free games, any remaining free games resume after

JACKPOT FEATURE ends. Credits bet, GOLD PAYS and ways played during the free games are the same as the game that triggered the free games.

JACKPOT FEATURE

There is a chance that the JACKPOT FEATURE may be triggered when 1 or more appears.



In the JACKPOT FEATURE, select from 12 icons until 3 matching symbols corresponding to a JACKPOT level are revealed.

When 3 matching JACKPOT level symbols have been revealed, the corresponding JACKPOT level is won and the JACKPOT FEATURE ends.

JACKPOT levels available according to GOLD PAYS played. The chances of revealing each jackpot symbol are not equal.

JACKPOT FEATURE and BONUS SURPRISE cannot be triggered in the same game.

BONUS SURPRISE



There is a chance that the BONUS SURPRISE may be triggered when 1 or more appears.

When the BONUS SURPRISE occurs, 250000 credits are awarded.

BONUS SURPRISE and JACKPOT FEATURE cannot be triggered in the same game.

Any BONUS SURPRISE win is added to line wins.



TYPE OF FEATURES

Free Game + LP

REEL CONFIGURATION

5-Reel 3-4-4-4-3-Row Video Slot

PAYLINES

576 Ways

DENOMINATIONS

1c

BET CONFIGURATIONS

1, 2, 3, 4, 5, 6, 7, 8, 9, 10

MIN/MAX BET

18 up to 880

(Depends on the above Bet Configurations)

FU RU YI 福如意





Engaging and dynamic gameplay throughout with many player-customizable options. Players can choose several levels of improved reels to play. Players also choose the volatility level of free games by picking the reel type, reel format and number of free games played. Increasing the bet multiplier also exceedingly improves the size of bonus prizes in the jackpot feature consisting of five prize levels. A special wild not only triples symbol wins, it adds extra free games and triples the number of jackpot games when appearing in the triggering game of these respective features. A large mystery bonus also adds a fun surprise.



IMPROVED REELS

PLAY OPTIONS	
PLAY 88 CREDITS	Reels do not contain A, K, Q and J.
PLAY 78 CREDITS	Reels do not contain K, Q and J.
PLAY 58 CREDITS	Reels do not contain Q and J.
PLAY 38 CREDITS	Reels do not contain J.
PLAY 18 CREDITS	Reels contain all symbols.

Reels contains fewer lower-paying symbols



FORTUNE BONUS

FORTUNE BONUS randomly occurs in bought games and free games.



FREE GAMES FEATURE

福 appearing on 3 or more consecutive reels beginning with the leftmost reel trigger the free games.

Select reel format and then reel type from the available free game options.

If 福 appears in the game that triggers the free games, the number of free games is increased for the free game options.

The number of free games awarded depends on the selection of reel format and the inclusion of 福, 福 and 福 on the reels.



JACKPOT FEATURE

There is a chance the JACKPOT FEATURE may be triggered when 1 or more 福 / 福 appear.

If 福 appears in the game that triggered the JACKPOT FEATURE, a total of 3 JACKPOT FEATURES are awarded and played one after the other.

Select an icon by touching it on the screen, or randomly select an icon by pressing the PLAY button.

When 3 matching symbols have been revealed, the corresponding PRIZE is won and the JACKPOT FEATURE ends.

The JACKPOT FEATURE awards the following:

- 3 JACKPOT LEVELS: GRAND, SUPER, MAJOR
- 2 BONUS PRIZES: MINOR and MINI

BONUS PRIZES INCREASED IN EXCESS OF BET MULTIPLIER

BONUS PRIZES		
BONUS PRIZES INCREASED IN EXCESS OF BET MULTIPLIER		
BET MULTIPLIER	MINOR	MINI
x10	\$1,000.00	\$200.00
x6	\$500.00	\$100.00
x3	\$200.00	\$40.00
x2	\$125.00	\$25.00
x1	\$50.00	\$10.00



TYPE OF FEATURES

Free Game + LP

REEL CONFIGURATION

5-Reel 3-Row Video Slot

PAYLINES

243 Ways

(FREE GAMES: 1024 or 3125 or 7776 WAYS)

DENOMINATIONS

1c

BET CONFIGURATIONS

1, 2, 3, 6, 10

MAX BET

880



Engaging and dynamic gameplay throughout with many player-customizable options. Players can choose several levels of improved reels to play. Players also choose the volatility level of free games by picking the multipliers, reel format and number of free games played. Increasing the bet multiplier also exceedingly improves the size of bonus prizes in the jackpot feature consisting of five prize levels. A special wild not only triples symbol wins, it adds extra free games and triples the number of jackpot games when appearing in the triggering game of these respective features. A large mystery bonus also adds a fun surprise.

TYPE OF FEATURES

Free Game + LP

REEL CONFIGURATION

5-Reel 3-Row Video Slot

PAYLINES

243 Ways

(FREE GAMES: 1024 or 3125 or 7776 WAYS)

DENOMINATIONS

1c

BET CONFIGURATIONS

1, 2, 3, 6, 10

MAX BET

880



IMPROVED REELS

PLAY OPTIONS	
PLAY 88 CREDITS	Reels do not contain A, K, Q, and J.
PLAY 78 CREDITS	Reels do not contain K, Q, and J.
PLAY 58 CREDITS	Reels do not contain Q and J.
PLAY 38 CREDITS	Reels do not contain J.
PLAY 18 CREDITS	Reels contain all symbols.

Reels contains fewer lower-paying symbols



FORTUNE BONUS

FORTUNE BONUS randomly occurs in bought games and free games.



FREE GAMES FEATURE

🐷 appearing on 3 or more consecutive reels beginning with the leftmost reel trigger the free games.

Select reel format and then max multiplier from the available free game options.

If 🐷 appears in the game that triggers the free games, the number of free games is increased for the free game options.

If 🐷 appears in a free game, all 🎰 pays in that spin are multiplied by the multiplier displayed on 🐷.



JACKPOT FEATURE

There is a chance the JACKPOT FEATURE may be triggered when 1 or more 🐷 / 🐷 appear.

If 🐷 appears in the game that triggered the JACKPOT FEATURE, a total of 3 JACKPOT FEATURES are awarded and played one after the other.

Select an icon by touching it on the screen, or randomly select an icon by pressing the PLAY button.

When 3 matching symbols have been revealed, the corresponding PRIZE is won and the JACKPOT FEATURE ends.

The JACKPOT FEATURE awards the following:

- 3 JACKPOT LEVELS: GRAND, SUPER, MAJOR
- 2 BONUS PRIZES: MINOR and MINI

BONUS PRIZES INCREASED IN EXCESS OF BET MULTIPLIER

BONUS PRIZES		
BONUS PRIZES INCREASED IN EXCESS OF BET MULTIPLIER		
BET MULTIPLIER	MINOR	MINI
x10	\$1,000.00	\$200.00
x6	\$500.00	\$100.00
x3	\$200.00	\$40.00
x2	\$125.00	\$25.00
x1	\$50.00	\$10.00

Speed

Entertainment has a classy new look.

Players can enjoy an exciting gaming experience.

Optimal service design for accessibility and maintenance.



Stunning HD Graphics

An LCD monitor with dual 27-inch LCD high definition monitor.



Immersive Audio

Newly designed sound system creates powerful theater-like sound.



USB charging

USB charging port & wireless Charger also provided for player convenience.

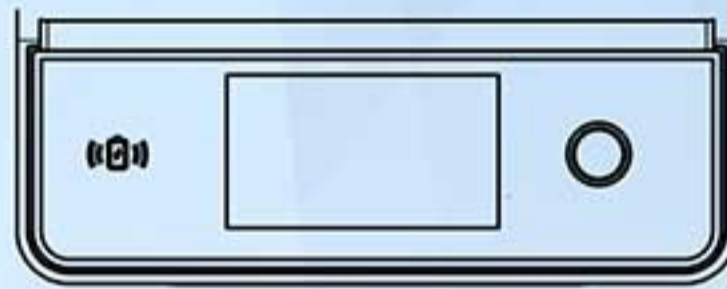

Ergonomic button deck

Premium Speed 11.6-inch LCD Touch Screen panel with Bash Button.

DIMENSION

(with Custom Stand Base version)

Upright Height

(Tower Light Included)

96.92 in (2461.7 mm)

Upright Height

(Tower Light Excluded)

92.67 in (2353.7 mm)

Width

26.77 in (680 mm)

Depth

24.84 in (631 mm)

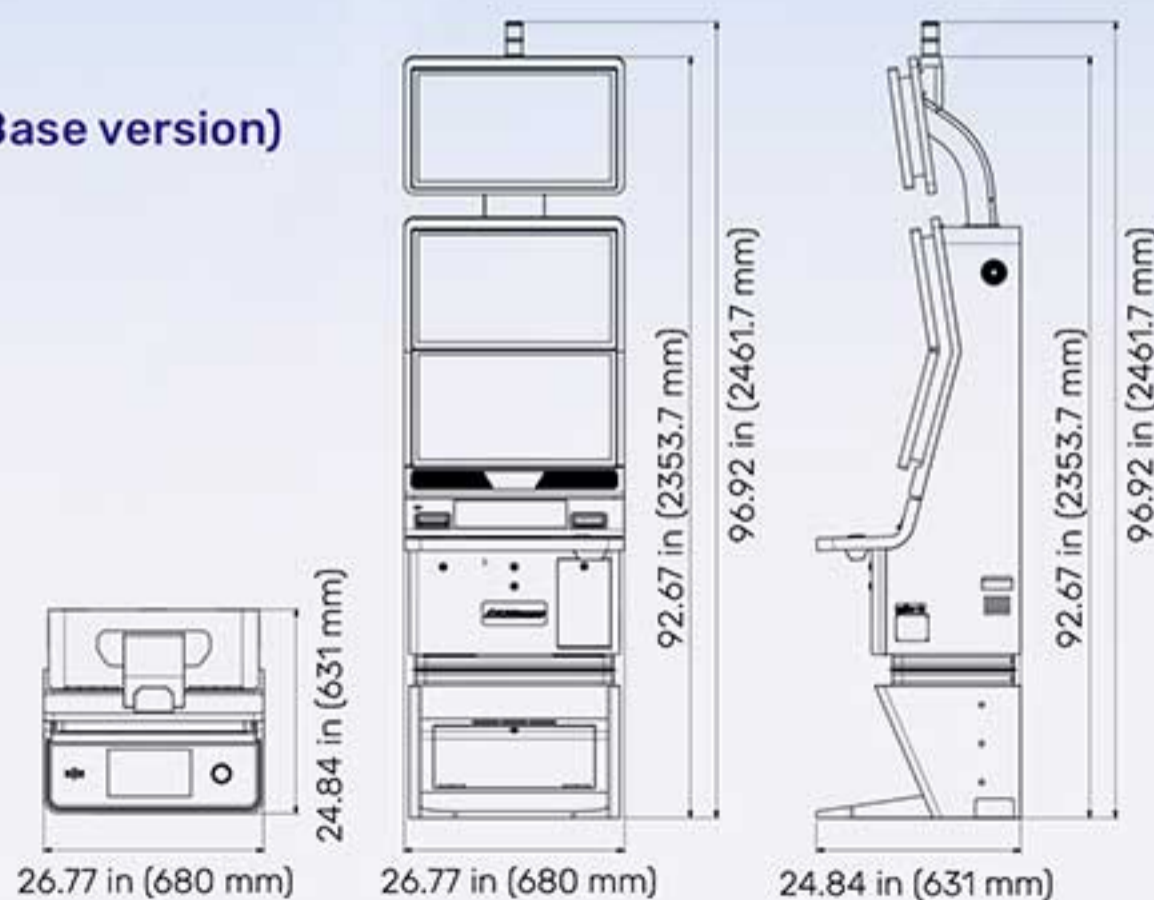

Speed

Entertainment has a classy new look.

Players can enjoy an exciting gaming experience.

Optimal service design for accessibility and maintenance.



Stunning HD Graphics

An LCD monitor with dual 27-inch LCD high definition monitor.



Immersive Audio

Newly designed sound system creates powerful theater-like sound.



USB charging

USB charging port & wireless Charger also provided for player convenience.

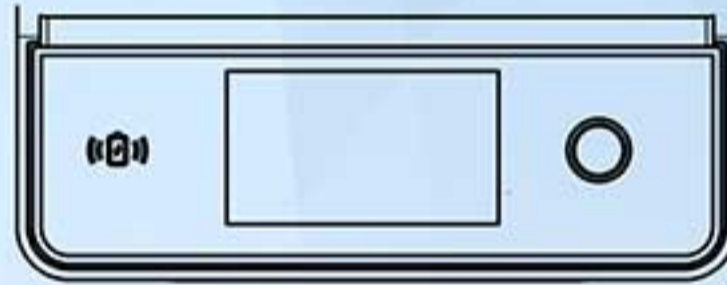

Ergonomic button deck

Premium Speed 11.6-inch LCD Touch Screen panel with Bash Button.



DIMENSION

(Upright version)

Upright Height
(Tower Light Included)
78.92 in (2004.5 mm)

Upright Height
(Tower Light Excluded)
74.67 in (1896.5 mm)

Width
26.77 in (680 mm)

Depth
24.82 in (630.5 mm)

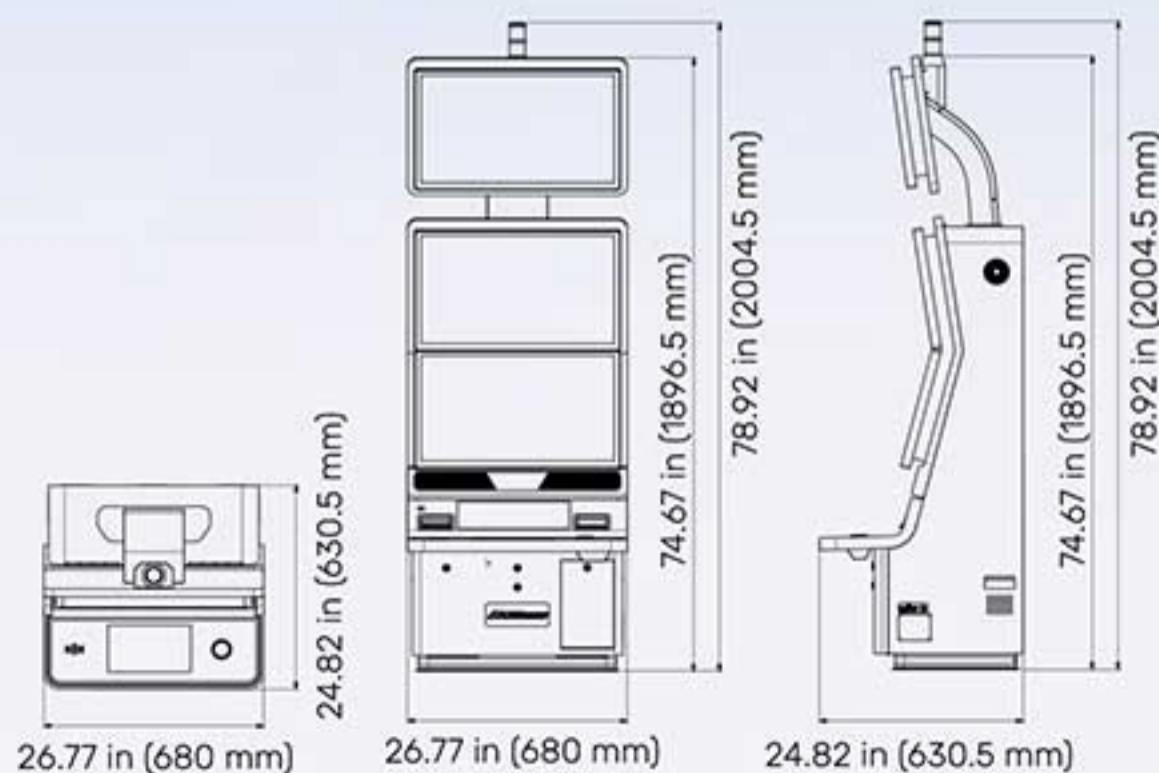

Orb of Wealth™

Orb of Wealth
GRAND
\$10,000.00
MAJOR
\$800.00

Orb of Wealth
GRAND
\$10,000.00
MAJOR
\$800.00

MINOR **\$25.00** MINI **\$10.00**
ROYALS REMOVED
FREE GAMES

MINOR **\$25.00** MINI **\$10.00**
SHINING FORTUNE
FREE GAMES

6 or more trigger FREE GAMES

Dragon	Dragon	Dragon	Dragon	Dragon
Dragon	Dragon	Dragon	Dragon	Dragon
Dragon	Dragon	Dragon	Dragon	Dragon
Dragon	Dragon	Dragon	Dragon	Dragon
Dragon	Dragon	Dragon	Dragon	Dragon
Dragon	Dragon	Dragon	Dragon	Dragon

1c CREDIT 0 BET 88 WIN 0

6 or more trigger FREE GAMES

Dragon	Dragon	Dragon	Dragon	Dragon
Dragon	Dragon	Dragon	Dragon	Dragon
Dragon	Dragon	Dragon	Dragon	Dragon
Dragon	Dragon	Dragon	Dragon	Dragon
Dragon	Dragon	Dragon	Dragon	Dragon
Dragon	Dragon	Dragon	Dragon	Dragon

1c CREDIT 0 BET 88 WIN 0





Powerful repeating wins when fate and luck combine. Special scatter symbols trigger the free games feature in which the sum of credit prizes displayed on these triggering symbols is paid for each scatter that appears during the free games. When one or more wild symbols appear in a bought game, there is a chance to trigger the jackpot feature containing four progressive levels.

JACKPOT FEATURE



There is a chance that the JACKPOT FEATURE may be triggered when 1 or more **WILD** appear in bought games only.

In the JACKPOT FEATURE, there are 4 types of jackpot symbols hidden behind 12 icons. Select an icon until 3 matching jackpot symbols corresponding to a JACKPOT are revealed.

FREE GAMES FEATURE



Any 6 or more **Orb** in a bought game trigger 6 free games.

Each **Orb** that appears during the free games pays the ORB PRIZE.

Before the free games start, the ORB PRIZE credit amount is determined as the sum of numbers that are displayed on all **Orb** appearing in the bought game that triggered the free games.

Royal symbols do not appear in free games.

TYPE OF FEATURES

Free Game + LP

REEL CONFIGURATION

5-Reel 3-Row Video Slot

PAYLINES

243 Ways

DENOMINATIONS

1c

BET CONFIGURATIONS

1, 2, 3, 4, 5, 6, 7, 8, 9, 10

MAX BET

88 Bet to 880 Bet

(Depends on the above Bet Configurations)



Powerful repeating wins when fate and luck combine. Special scatter symbols trigger the free games feature in which the sum of credit prizes displayed on these triggering symbols is paid for each scatter that appears during the free games. When one or more wild symbols appear in a bought game, there is a chance to trigger the jackpot feature containing four progressive levels.

JACKPOT FEATURE



There is a chance that the JACKPOT FEATURE may be triggered when 1 or more **WILD** appear in bought games only.

In the JACKPOT FEATURE, there are 4 types of jackpot symbols hidden behind 12 icons.

Select an icon until 3 matching jackpot symbols corresponding to a JACKPOT are revealed.

FREE GAMES FEATURE



Any 6 or more scatter symbols in a bought game trigger 6 free games.

Each scatter symbol that appears during the free games pays the ORB PRIZE.

Each scatter symbol that appears during the free games awards 1 additional free game.

Before the free games start, the ORB PRIZE credit amount is determined as the sum of numbers that are displayed on all scatter symbols appearing in the bought game that triggered the free games.



TYPE OF FEATURES

Free Game + LP

REEL CONFIGURATION

5-Reel 3-Row Video Slot

PAYLINES

243 Ways

DENOMINATIONS

1c

BET CONFIGURATIONS

1, 2, 3, 4, 5, 6, 7, 8, 9, 10

MAX BET

88 Bet to 880 Bet

(Depends on the above Bet Configurations)

BOUND FOR RICHES™



TYPE OF FEATURES

Free Game + LP

REEL CONFIGURATION

5-Reel 3-Row Video Slot

PAYLINES

50 Lines (Denomination 1 & 2)

25 Lines (Denomination 3 & 4)

5 Lines (Denomination 5 & 6)

DENOMINATIONS

1	2	3	4	5	6
1c	2c	5c	10c	\$1	\$2
2c	5c	10c	20c	\$2	\$5
5c	10c	25c	50c	\$5	\$10
10c	20c	50c	\$1	\$10	\$20
20c	50c	\$1	\$2	\$20	\$50
50c	\$1	\$2.50	\$5	\$50	\$100
\$1	\$2	\$5	\$10	\$100	\$200
1c	2c	5c	10c		
2c	5c	10c	20c		
5c	10c	25c	50c		
10c	20c	50c	\$1		
20c	50c	\$1	\$2		
50c	\$1	\$2.50	\$5		
\$1	\$2	\$5	\$10		
\$5	\$10	\$25	\$50		
\$10	\$20	\$50	\$100		

BET CONFIGURATIONS

1, 2, 3, 4, 5

1, 2, 3, 5, 10

MAX BET

250, 500 (Denomination 1 & 2)

125, 250 (Denomination 3 & 4)

25, 50 (Denomination 5 & 6)



Choo! Choo! Hop on board the golden express destined for cash and prizes. All prizes displayed on special scatter symbols that are held during the collect feature are won, including bonus and jackpot prizes. When the special scatters fill the reels in any game, additional prizes including bonuses and jackpots are won in a pick game. Additionally, jackpots may be won randomly during bought games. Free games feature reels with extra wild.

FREE GAMES FEATURE



COLLECT FEATURE



PRIZE PICK FEATURE



JACKPOT SURPRISE



TYPE OF FEATURES

Free Game + LP

REEL CONFIGURATION

5-Reel 3-Row Video Slot

PAYLINES

50 Lines (Denomination 1 & 2)

25 Lines (Denomination 3 & 4)

5 Lines (Denomination 5 & 6)

DENOMINATIONS

1	2	3	4	5	6
1c	2c	5c	10c	\$1	\$2
2c	5c	10c	20c	\$2	\$5
5c	10c	25c	50c	\$5	\$10
10c	20c	50c	\$1	\$10	\$20
20c	50c	\$1	\$2	\$20	\$50
50c	\$1	\$2.50	\$5	\$50	\$100
\$1	\$2	\$5	\$10	\$100	\$200
1c	2c	5c	10c		
2c	5c	10c	20c		
5c	10c	25c	50c		
10c	20c	50c	\$1		
20c	50c	\$1	\$2		
50c	\$1	\$2.50	\$5		
\$1	\$2	\$5	\$10		
\$5	\$10	\$25	\$50		
\$10	\$20	\$50	\$100		

BET CONFIGURATIONS

1, 2, 3, 4, 5

1, 2, 3, 5, 10

MAX BET

250, 500 (Denomination 1 & 2)

125, 250 (Denomination 3 & 4)

25, 50 (Denomination 5 & 6)



Choo! Choo! Hop on board the golden express destined for cash and prizes. All prizes displayed on special scatter symbols that are held during the collect feature are won, including bonus and jackpot prizes. When the special scatters fill the reels in any game, additional prizes including bonuses and jackpots are won in a pick game. Additionally, jackpots may be won randomly during bought games. Free games feature mystery symbols that all become the same symbol.

FREE GAMES FEATURE



COLLECT FEATURE



PRIZE PICK FEATURE



JACKPOT SURPRISE





Choo! Choo! Hop on board the golden express destined for cash and prizes. All prizes displayed on special scatter symbols that are held during the collect feature are won, including bonus and jackpot prizes. When the special scatters fill the reels in any game, additional prizes including bonuses and jackpots are won in a pick game. Additionally, jackpots may be won randomly during bought games. Free games feature wild that nudge the reel making it all wild.

FREE GAMES FEATURE



COLLECT FEATURE



PRIZE PICK FEATURE



JACKPOT SURPRISE



TYPE OF FEATURES

Free Game + LP

REEL CONFIGURATION

5-Reel 3-Row Video Slot

PAYLINES

50 Lines (Denomination 1 & 2)

25 Lines (Denomination 3 & 4)

5 Lines (Denomination 5 & 6)

DENOMINATIONS

1	2	3	4	5	6
1c	2c	5c	10c	\$1	\$2
2c	5c	10c	20c	\$2	\$5
5c	10c	25c	50c	\$5	\$10
10c	20c	50c	\$1	\$10	\$20
20c	50c	\$1	\$2	\$20	\$50
50c	\$1	\$2.50	\$5	\$50	\$100
\$1	\$2	\$5	\$10	\$100	\$200
1c	2c	5c	10c		
2c	5c	10c	20c		
5c	10c	25c	50c		
10c	20c	50c	\$1		
20c	50c	\$1	\$2		
50c	\$1	\$2.50	\$5		
\$1	\$2	\$5	\$10		
\$5	\$10	\$25	\$50		
\$10	\$20	\$50	\$100		

BET CONFIGURATIONS

1, 2, 3, 4, 5

1, 2, 3, 5, 10

MAX BET

250, 500 (Denomination 1 & 2)

125, 250 (Denomination 3 & 4)

25, 50 (Denomination 5 & 6)

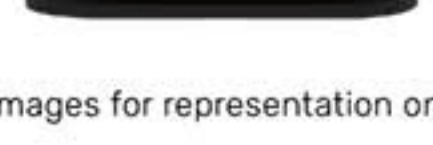
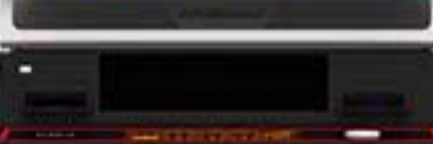

Choo! Choo! Hop on board the golden express destined for cash and prizes. All prizes displayed on special scatter symbols that are held during the collect feature are won, including bonus and jackpot prizes. When the special scatters fill the reels in any game, additional prizes including bonuses and jackpots are won in a pick game. Additionally, jackpots may be won randomly during bought games.

FREE GAMES FEATURE



COLLECT FEATURE



PRIZE PICK FEATURE



JACKPOT SURPRISE



TYPE OF FEATURES

Free Game + LP

REEL CONFIGURATION

5-Reel 3-Row Video Slot

PAYLINES

50 Lines (Denomination 1 & 2)

25 Lines (Denomination 3 & 4)

5 Lines (Denomination 5 & 6)

DENOMINATIONS

1	2	3	4	5	6
1c	2c	5c	10c	\$1	\$2
2c	5c	10c	20c	\$2	\$5
5c	10c	25c	50c	\$5	\$10
10c	20c	50c	\$1	\$10	\$20
20c	50c	\$1	\$2	\$20	\$50
50c	\$1	\$2.50	\$5	\$50	\$100
\$1	\$2	\$5	\$10	\$100	\$200
1c	2c	5c	10c		
2c	5c	10c	20c		
5c	10c	25c	50c		
10c	20c	50c	\$1		
20c	50c	\$1	\$2		
50c	\$1	\$2.50	\$5		
\$1	\$2	\$5	\$10		
\$5	\$10	\$25	\$50		
\$10	\$20	\$50	\$100		

BET CONFIGURATIONS

1, 2, 3, 4, 5

1, 2, 3, 5, 10

MAX BET

250, 500 (Denomination 1 & 2)

125, 250 (Denomination 3 & 4)

25, 50 (Denomination 5 & 6)

CO CO CO COIN

EGYPTIAN TREASURE

CO CO CO COIN

PIRATES TREASURE





Wild keys of fortune possess the power to unlock golden riches. Jackpot, bonus and credit prizes on gold coins are won when appearing in any position on 3 or more consecutive reels beginning with the leftmost reel. More coins appear on the first three reels during free games and even more coins appear on all reels in a respin that is triggered randomly when wild appears during bought games.

TREASURE RESPIN



There is a chance that a TREASURE RESPIN is randomly triggered when 1 or more appear in bought spins only.

After all wins are determined in the bought spin that triggers the TREASURE RESPIN, all reels respin automatically in one free spin and any new wins are added.

Different reels with extra on reels 1, 2, 3, 4 and 5 are used in the TREASURE RESPIN.

TREASURE RESPIN cannot be triggered again in the TREASURE RESPIN.

FREE GAMES FEATURE



Any 3 or more trigger the FREE GAMES FEATURE awarding 10 FREE GAMES. Reels 1, 2 and 3 contain extra during the FREE GAMES FEATURE compared to bought games.

FREE GAMES FEATURE can be triggered again during the FREE GAMES FEATURE.

If the FREE GAMES FEATURE and TREASURE RESPIN are triggered in the same bought spin, the FREE GAMES FEATURE starts after the TREASURE RESPIN.

If the FREE GAMES FEATURE is then triggered again in the TREASURE RESPIN, the sum of FREE GAMES awarded for the two triggered FREE GAMES FEATURES are played in a single FREE GAMES FEATURE that starts after the TREASURE RESPIN ends.

JACKPOT AND BONUS PRIZES



are special bonus symbols that are excluded from wins. Prizes displayed on are paid one time only for all appearing in any position on 3 or more consecutive reels beginning with the leftmost reel.

Each displays 1 of the available prizes below:

- PRIZE AMOUNT: equal to the total credits bet multiplied by a randomly determined multiplier as displayed. Available multipliers correspond to the reel that appears on:
 - Reels 1 to 3: multipliers 1, 2, 3, 4, 5, 6, 8 and 10.
 - Reel 4: multipliers 1, 2, 3, 4, 5, 6, 8, 10, 15, 20, 30 and 40.
 - Reel 5: multipliers 1, 2, 3, 4, 5, 6, 8, 10, 15, 20, 30, 40, 50, 60, 100 and 200.
- MAJOR BONUS, MINOR BONUS or MINI BONUS
- GRAND JACKPOT or MEGA JACKPOT

TYPE OF FEATURES

Free Game

REEL CONFIGURATION

5-Reel 3-Row Video Slot

PAYLINES

243 Ways

DENOMINATIONS

1	2	3	4	5	6
1c	2c	5c	10c	\$1	\$2
5c	10c	25c	50c	\$5	\$10
10c	20c	50c	\$1	\$10	\$20
50c	\$1	\$2.50	\$5	\$50	\$100
\$1	\$2	\$5	\$10	\$100	\$200
1c	2c	5c	10c		
2c	5c	10c	20c		
5c	10c	25c	50c		
10c	20c	50c	\$1		
20c	50c	\$1	\$2		
50c	\$1	\$2.50	\$5		
\$1	\$2	\$5	\$10		
\$5	\$10	\$25	\$50		
\$10	\$20	\$50	\$100		

BET CONFIGURATIONS

- 1, 2, 3, 4, 5
- 1, 2, 3, 5, 8
- 1, 2, 3, 5, 10
- 1, 2, 5, 10, 20

MAX BET

- 250, 400, 500, 1000 (Denomination 1, 2)
- 125, 200, 250, 500 (Denomination 3, 4)
- 25, 40, 50, 100 (Denomination 5, 6)



Wild keys of fortune possess the power to unlock golden riches. Jackpot, bonus and credit prizes on gold coins are won when appearing in any position on 3 or more consecutive reels beginning with the leftmost reel. More coins appear on the first three reels during free games and even more coins appear on all reels in a respin that is triggered randomly when wild appears during bought games.

TREASURE RESPIN



There is a chance that a TREASURE RESPIN is randomly triggered when 1 or more appear in bought spins only.

After all wins are determined in the bought spin that triggers the TREASURE RESPIN, all reels respin automatically in one free spin and any new wins are added.

Different reels with extra on reels 1, 2, 3, 4 and 5 are used in the TREASURE RESPIN.

TREASURE RESPIN cannot be triggered again in the TREASURE RESPIN.

FREE GAMES FEATURE



Any 3 or more trigger the FREE GAMES FEATURE awarding 10 FREE GAMES. Reels 1, 2 and 3 contain extra during the FREE GAMES FEATURE compared to bought games.

FREE GAMES FEATURE can be triggered again during the FREE GAMES FEATURE.

If the FREE GAMES FEATURE and TREASURE RESPIN are triggered in the same bought spin, the FREE GAMES FEATURE starts after the TREASURE RESPIN.

If the FREE GAMES FEATURE is then triggered again in the TREASURE RESPIN, the sum of FREE GAMES awarded for the two triggered FREE GAMES FEATURES are played in a single FREE GAMES FEATURE that starts after the TREASURE RESPIN ends.

JACKPOT AND BONUS PRIZES



are special bonus symbols that are excluded from wins. Prizes displayed on are paid one time only for all appearing in any position on 3 or more consecutive reels beginning with the leftmost reel.

Each displays 1 of the available prizes below:

- PRIZE AMOUNT: equal to the total credits bet multiplied by a randomly determined multiplier as displayed. Available multipliers correspond to the reel that appears on:
 - Reels 1 to 3: multipliers 1, 2, 3, 4, 5, 6, 8 and 10.
 - Reel 4: multipliers 1, 2, 3, 4, 5, 6, 8, 10, 15, 20, 30 and 40.
 - Reel 5: multipliers 1, 2, 3, 4, 5, 6, 8, 10, 15, 20, 30, 40, 50, 60, 100 and 200.
- MAJOR BONUS, MINOR BONUS or MINI BONUS
- GRAND JACKPOT or MEGA JACKPOT



TYPE OF FEATURES

Free Game

REEL CONFIGURATION

5-Reel 3-Row Video Slot

PAYLINES

243 Ways

DENOMINATIONS

1	2	3	4	5	6
1c	2c	5c	10c	\$1	\$2
5c	10c	25c	50c	\$5	\$10
10c	20c	50c	\$1	\$10	\$20
50c	\$1	\$2.50	\$5	\$50	\$100
\$1	\$2	\$5	\$10	\$100	\$200
1c	2c	5c	10c		
2c	5c	10c	20c		
5c	10c	25c	50c		
10c	20c	50c	\$1		
20c	50c	\$1	\$2		
50c	\$1	\$2.50	\$5		
\$1	\$2	\$5	\$10		
\$5	\$10	\$25	\$50		
\$10	\$20	\$50	\$100		

BET CONFIGURATIONS

- 1, 2, 3, 4, 5
- 1, 2, 3, 5, 8
- 1, 2, 3, 5, 10
- 1, 2, 5, 10, 20

MAX BET

- 250, 400, 500, 1000 (Denomination 1, 2)
- 125, 200, 250, 500 (Denomination 3, 4)
- 25, 40, 50, 100 (Denomination 5, 6)

DANCING PANDA™ FORTUNE

DANCING PANDA™ FESTIVAL

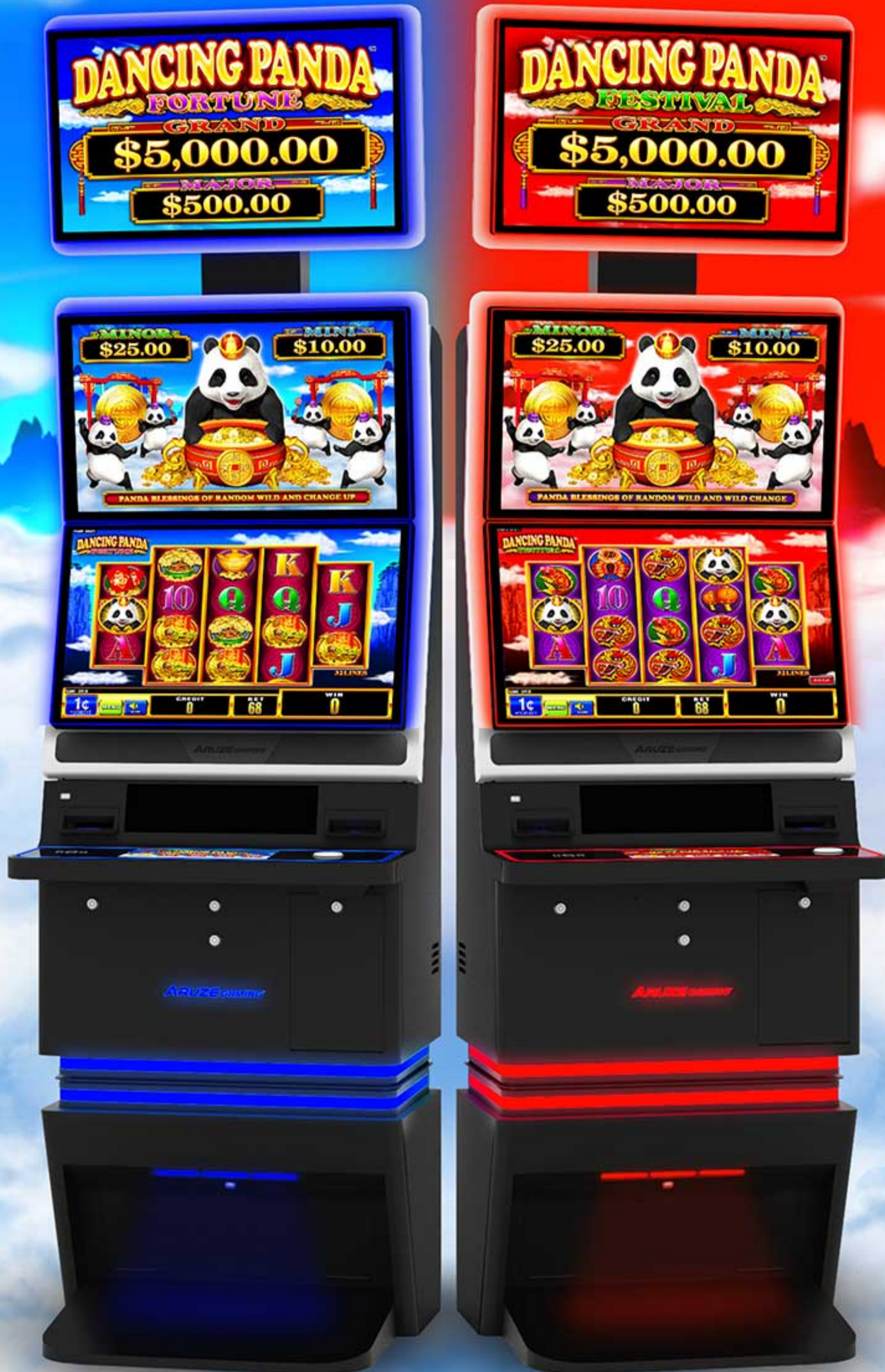



Happy blessings come from wild surprises. During bought games and free games, multiple lower-paying symbol kinds on all reels may randomly become a single higher-paying symbol kind. Alternatively, line wins may be multiplied by randomly appearing multiplier wild symbols. When wild symbols appear, there is a chance to trigger a special prize reel that awards jackpots, free games or both. Multiple jackpots may be won on the special prize reel.

RANDOM FEATURES

RANDOM WILD

RANDOM WILD randomly occurs during bought games and free games. All / substituting in a line win multiply the pay for that line only.

CHANGE UP

CHANGE UP randomly occurs during bought games and free games.

In the spin that CHANGE UP occurs, all **A, K, Q, J, 10** and **9** on the reels change to 1 of the following symbols: , , , or .



FREE GAMES

3 or more scattered trigger the free games. During the free games, each awards 1, 2 or 3 additional free games.



PRIZE REEL

There is a chance PRIZE REEL may be triggered when / / appear during any bought game or free game.

When the PRIZE REEL is triggered, a large PRIZE REEL is displayed on the game screen and spun once only. If the PRIZE REEL indicates only a jackpot win, the jackpot is won and there is a chance that the PRIZE REEL may spin again.



TYPE OF FEATURES

Free Game + LP

REEL CONFIGURATION

5-Reel 3-4-4-4-3-Row Video Slot

PAYLINES

32 Lines

DENOMINATIONS

1c

BET CONFIGURATIONS

1, 2, 3, 4, 5, 6, 7, 8, 9, 10

MAX BET

Up to 680

(Depends on the above Bet Configurations)



Happy blessings come from wild surprises. During bought games, multiple symbol kinds on all reels may randomly become wild symbols. During bought games and free games, line wins may be multiplied by randomly appearing multiplier wild symbols. When wild symbols appear, there is a chance to trigger a special prize reel that awards jackpots, free games or both. Multiple jackpots may be won on the special prize reel.

RANDOM FEATURES

RANDOM WILD

RANDOM WILD randomly occurs during bought games and free games. All / substituting in a line win multiply the pay for that line only.

WILD CHANGE

WILD CHANGE randomly occurs during bought games only.

In the game that WILD CHANGE occurs, 3 or more of the symbol kinds / / / / on all reels randomly change to .



TYPE OF FEATURES

Free Game + LP

REEL CONFIGURATION

5-Reel 3-4-4-4-3-Row Video Slot

PAYLINES

32 Lines

DENOMINATIONS

1c

BET CONFIGURATIONS

1, 2, 3, 4, 5, 6, 7, 8, 9, 10

MAX BET

Up to 680

(Depends on the above Bet Configurations)

FREE GAMES

Free games consist of 8 free games. During free games, 3 or more scattered award 5 additional free games.



PRIZE REEL

There is a chance PRIZE REEL may be triggered when / / appear during any bought game or free game.

When the PRIZE REEL is triggered, a large PRIZE REEL is displayed on the game screen and spun once only. If the PRIZE REEL indicates only a jackpot win, the jackpot is won and there is a chance that the PRIZE REEL may spin again.



FU LAI CAI LAI 福来财来

5 SEA
LEGENDS™

TRIPLE
FESTIVAL™

STACK WILD
LUXURY™

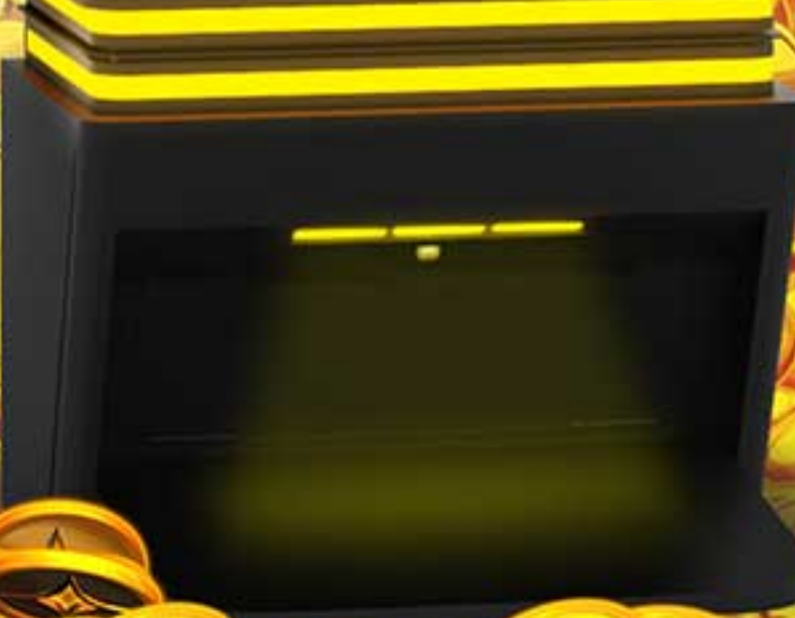
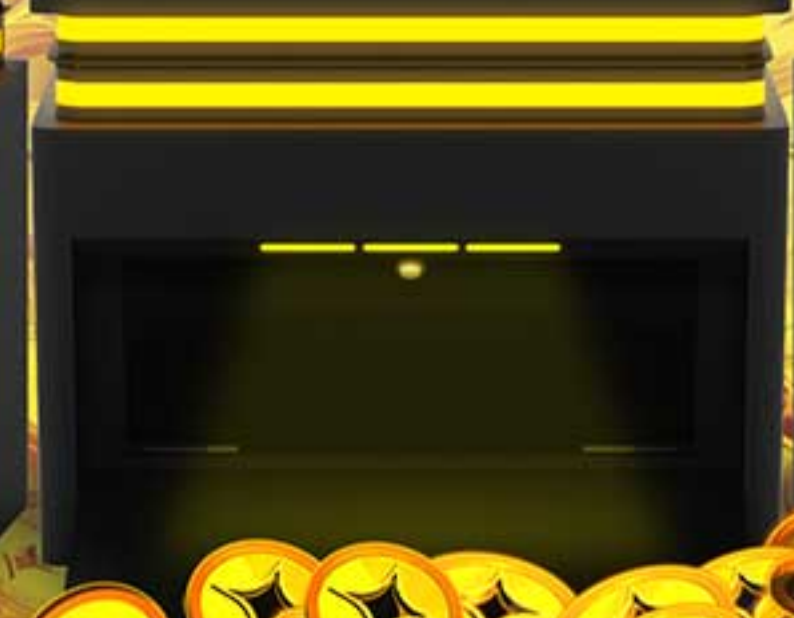



Experience an enriching variety of gameplay and surprising riches. Increasing the bet level and credit per play improve several elements of gameplay.

TYPE OF FEATURES

Free Game + LP

REEL CONFIGURATION

5-Reel 3-Row Video Slot

PAYLINES

243 Ways

DENOMINATIONS

1c

BET CONFIGURATIONS

1, 2, 3, 6, 10

MAX BET

880

FU LAI CAI LAI TRIPLE FESTIVAL

appearing on 3 or more consecutive reels beginning with the leftmost reel trigger the FREE GAMES FEATURE with 8 FREE GAMES. During FREE GAMES FEATURE, reels contains Picture symbols only.

FREE GAMES FEATURE can be triggered again during the FREE GAMES FEATURE.

If the FREE GAMES FEATURE is triggered in the same game as the JACKPOT FEATURE, the FREE GAMES FEATURE starts after the JACKPOT FEATURE ends.

FU LAI CAI LAI 5 SEA LEGENDS

appearing on 3 or more consecutive reels beginning with the leftmost reel trigger the FREE GAMES FEATURE with 6 FREE GAMES.

Before FREE GAMES start, select 1 of the symbols from the available options.

If the FREE GAMES FEATURE was triggered when playing bet level 2 or higher, the reels used during the FREE GAMES are composed with the following symbols only: the symbol selected from the available options,

If the FREE GAMES FEATURE was triggered when playing bet level 1, the reels used during the FREE GAMES are composed with the following symbols only: the symbol selected from the available options,

During the FREE GAMES, appearing on 3 or more consecutive reels beginning with the leftmost reel award an additional 6 FREE GAMES, however the selection of the symbol option is not made again.

If the FREE GAMES FEATURE is triggered in the same game as the JACKPOT FEATURE, the FREE GAMES FEATURE starts after the JACKPOT FEATURE ends.

FU LAI CAI LAI STACK WILD LUXURY

appearing on 3 or more consecutive reels beginning with the leftmost reel trigger the FREE GAMES FEATURE with 8 FREE GAMES.

During the FREE GAMES, all symbols on 1 or more reels (reels 2, 3, 4 and 5 according to bet level played) may randomly become .

FREE GAMES FEATURE cannot be triggered again during the FREE GAMES FEATURE.

If the FREE GAMES FEATURE is triggered in the same game as the JACKPOT FEATURE, the FREE GAMES FEATURE starts after the JACKPOT FEATURE ends.



JACKPOT FEATURE

The JACKPOT FEATURE can be triggered when playing bet level 2, 3, 4 or 5 only. There is a chance the JACKPOT FEATURE may be triggered when appears.

Alternatively, the JACKPOT FEATURE is triggered when the large drops down to be displayed on the game screen randomly in bought games and free games.

According to the bet level played, up to 4 jackpot levels may be available. In the JACKPOT FEATURE, select from 15 ingots until 3 matching symbols corresponding to a jackpot level are revealed.

If 3 are revealed, an additional JACKPOT FEATURE is awarded and the feature continues until a jackpot level is won.

When 3 matching jackpot level symbols have been revealed, the corresponding jackpot level is won and the JACKPOT FEATURE ends. Any additional JACKPOT FEATURE awarded, starts after the preceding JACKPOT FEATURE ends.

WILD COIN BONUS

There is a chance the WILD COIN BONUS may occur when 1 or more appear on the reels in a bought game or free game. When the WILD COIN BONUS occurs, a special credit prize displayed on the game screen is awarded. Special Credit Prize: total credits bet multiplied by either 10, 20, 30, 50 or 100 randomly as displayed.

FORTUNE DRUMS™





Spinning riches stir up excitement. Picture symbols are increased on reels according to the credits bet played. Special reels comprised exclusively of Picture, "Feature" and "Wild" symbols are used during the 10 Free Games. In DON DON DON, a big win awaits as either a bonus credit prize or 1 of 4 progressive levels is won.

FREE GAMES



DON DON DON



TYPE OF FEATURES

Video Wheel / Free Game + LP

REEL CONFIGURATION

5-Reel 3-Row Video Slot

PAYLINES

243 Ways

DENOMINATIONS

1¢

BET CONFIGURATIONS

1, 2, 3, 4, 5
1, 2, 3, 5, 10
1, 2, 5, 10, 15
1, 2, 5, 10, 20

MAX BET

440, 880, 1320, 1760



Spinning riches stir up excitement. Picture symbols are increased on reels according to the credits bet played. When the feature is triggered a Mini Game occurs, improving the reels used during 6 Free Games. In DON DON DON, a big win awaits as either a bonus credit prize or 1 of 4 progressive levels is won.

FREE GAMES



DON DON DON



TYPE OF FEATURES

Video Wheel / Free Game + LP

REEL CONFIGURATION

5-Reel 3-Row Video Slot

PAYLINES

243 Ways

DENOMINATIONS

1¢

BET CONFIGURATIONS

1, 2, 3, 4, 5
1, 2, 3, 5, 10
1, 2, 5, 10, 15
1, 2, 5, 10, 20

MAX BET

440, 880, 1320, 1760



Spinning riches stir up excitement. Picture symbols are increased on reels according to the credits bet played. 3 symbols held on reel 3 are used during 10 Free Games. In DON DON DON, a big win awaits as either a bonus credit prize or 1 of 4 progressive levels is won.

TYPE OF FEATURES

Video Wheel / Free Game + LP

REEL CONFIGURATION

5-Reel 3-Row Video Slot

PAYLINES

243 Ways

DENOMINATIONS

1c

BET CONFIGURATIONS

- 1, 2, 3, 4, 5
- 1, 2, 3, 5, 10
- 1, 2, 5, 10, 15
- 1, 2, 5, 10, 20

MAX BET

440, 880, 1320, 1760

FREE GAMES



DON DON DON



Spinning riches stir up excitement. Picture symbols are increased on reels according to the credits bet played. Special reels with consecutive wild symbols and no Royal symbols are used during the 8 Free Games. In DON DON DON, a big win awaits as either a bonus credit prize or 1 of 4 progressive levels is won.

TYPE OF FEATURES

Video Wheel / Free Game + LP

REEL CONFIGURATION

5-Reel 3-Row Video Slot

PAYLINES

243 Ways

DENOMINATIONS

1c

BET CONFIGURATIONS

- 1, 2, 3, 4, 5
- 1, 2, 3, 5, 10
- 1, 2, 5, 10, 15
- 1, 2, 5, 10, 20

MAX BET

440, 880, 1320, 1760

ZODIAC FEATURE



DON DON DON



COIN COLLECTOR™



5 GUARDIANS

COIN COLLECTOR™



AUSSIE5



Amass golden riches and rack up lots of free games. The number of free games awarded is determined by a number drawing conducted on each triggering feature symbol. Transforming symbols in bought games and free games all become the same symbol. Special scatters can trigger a collect feature in which all prizes displayed on the collected scatters are won, including bonuses and jackpots. Additionally, jackpots can be won randomly during bought games.

TYPE OF FEATURES

Free Game + LP

REEL CONFIGURATION

5-Reel 4-Row Video Slot

PAYLINES

50 Lines
25 Lines
4 Lines (Denomination 4, 5, 6 only)

DENOMINATIONS

1	2	3	4	5	6
1c	2c	5c	10c	\$1	\$2
5c	10c	25c	50c	\$5	\$10
10c	20c	50c	\$1	\$10	\$20
50c	\$1	\$2.50	\$5	\$50	\$100
2c	5c	10c	20c	\$2	\$5
20c	50c	\$1	\$2	\$20	\$50
1c	2c	5c	10c		
10c	20c	50c	\$1		
50c	\$1	\$2.50	\$5		
\$1	\$2	\$5	\$10		
\$5	\$10	\$25	\$50		
\$10	\$20	\$50	\$100		
2c	5c	10c	20c		
20c	50c	\$1	\$2		

BET CONFIGURATIONS

1, 2, 3, 4, 5
1, 2, 3, 5, 10

MIN/MAX BET

250, 500
125, 250
20, 40 (Denomination 4, 5, 6 only)

5 GUARDIANS / AUSSIE 5 FEATURE

/ appearing on 3 or more consecutive reels beginning with the leftmost reel trigger 5 GUARDIANS / AUSSIE 5 FEATURE.

When the GUARDIANS / AUSSIE 5 FEATURE is triggered, a number appears on each / that was involved in triggering the feature.

The sum of the numbers that appeared is awarded as free games in the GUARDIANS / AUSSIE 5 FEATURE.



MYSTERY SYMBOL

COIN COLLECTOR 5 GUARDIANS

appearing on the reels changes to after all reels finish spinning. All appearing in the same game randomly change to the same symbol.

COIN COLLECTOR AUSSIE 5

appearing on the reels changes to after all reels finish spinning. All appearing in the same game randomly change to the same symbol.



DREAM COLLECTOR

Any 6 or more scattered in a bought game or free game trigger DREAM COLLECTOR and are held for the duration of DREAM COLLECTOR. When DREAM COLLECTOR is triggered, 3 free spins are awarded.

Each newly appearing in DREAM COLLECTOR resets the number of remaining free spins to 3.

DREAM COLLECTOR ends after all awarded free spins have been played or if appears in all 20 symbol positions. GRAND JACKPOT is won if appears in all 20 symbol positions. prizes are added to the GRAND JACKPOT win.



JACKPOT SURPRISE

JACKPOT SURPRISE randomly occurs in bought games only.

When the JACKPOT SURPRISE occurs, 1 of the following prizes is randomly awarded:

- MAJOR JACKPOT
- GRAND JACKPOT
- BONUS



SUNLIGHT™ SAVANNA 5

SUNLIGHT™ JOYFUL LION



SUNLIGHT™

HYPER SYMBOL wins multiplied by total number of all matching symbols on the same reels. Rather than lines or ways, standard wins are based on the number of left-to-right reels with matching HYPER SYMBOL that are then multiplied by the total number of all matching HYPER SYMBOL on those winning reels.

TYPE OF FEATURES

Free Game + LP

REEL CONFIGURATION

5-Reel 3-Row Video Slot

PAYLINES

Hyper Symbols

DENOMINATIONS

1¢

BET CONFIGURATIONS

1, 2, 3, 4, 5

1, 2, 3, 5, 10

1, 2, 5, 10, 20

MAX BET

250, 500, 1000

FREE GAMES FEATURE

SUNLIGHT SAVANNA 5



Any 6 or more trigger the FREE GAMES FEATURE with an initial 5 free games and an initial x4 special multiplier that multiplies the HYPER SYMBOL MULTIPLIER.

Before the FREE GAMES FEATURE starts, each triggering reveals 1 of the following:

+1: Each +1 revealed awards 1 additional free game.

x1: Each x1 revealed increases the special multiplier applied during all free games by 1.

During the FREE GAMES FEATURE, any 6 or more each reveal +1 awarding a total number of additional free games equal to the number of appearing only.

FREE GAMES FEATURE starts after the JACKPOT FEATURE ends if triggered in the same game.

If the JACKPOT FEATURE is triggered during the FREE GAMES FEATURE, any remaining free games resume after the JACKPOT FEATURE ends.

SUNLIGHT JOYFUL LION



Any 6 or more trigger the FREE GAMES FEATURE with 10 free games.

Reels used during the FREE GAMES FEATURE contain an additional 30 , 60 or 120 randomly.

During the FREE GAMES FEATURE, any 6 or more award 10 additional free games.

FREE GAMES FEATURE starts after the JACKPOT FEATURE ends if triggered in the same game.

If the JACKPOT FEATURE is triggered during the FREE GAMES FEATURE, any remaining free games resume after the JACKPOT FEATURE ends.

JACKPOT FEATURE



Any combination of SUN SYMBOLS appearing on 3 or more consecutive reels beginning with the leftmost reel trigger the JACKPOT FEATURE.

In the JACKPOT FEATURE, the triggering SUN SYMBOLS are shuffled and then each is hidden behind a . SUN SYMBOL prizes are revealed after the is selected in the JACKPOT FEATURE.

Select 1 only to reveal the SUN SYMBOL and corresponding prize won for the JACKPOT FEATURE.

JACKPOT FEATURE win is added to any HYPER SYMBOL wins from the triggering game.

Jack's HAUNTED WINS

Jack's WINNING SPELL



In addition to free games, there is a chance to trigger a wide variety of unique features whenever wild symbols appear. Enjoy special prize reels, scattered wild, cascading wild, merging reels, a bonus collect feature and a special multiplier reel that increases all bonus wins and also awards jackpots.

TYPE OF FEATURES

Free Game + LP

REEL CONFIGURATION

5-Reel 3-4-4-4-3-Row Video Slot

PAYLINES

40 Lines

DENOMINATIONS

1c

BET CONFIGURATIONS

1, 2, 3, 4, 5, 6, 7, 8, 9, 10

MAX BET

Up to 600

(Depends on the above Bet Configurations)

MEGA SYMBOL



After all wins are determined in the game that MEGA SYMBOL is awarded, reels 2, 3 and 4 merge to form one large center reel for 1 free spin only. In the free spin, reels 1 and 5 are held and only the large center reel is spun.

PRIZE REEL



In PRIZE REEL, select 1 of 3 🎱 / 🎱 to reveal the number of prize reel spins awarded: 1 SPIN, 2 SPINS or 3 SPINS.

After the number of awarded prize reel spins has been revealed, a large pumpkin containing the prize reel appears on the game screen.

WILD REEL SPIN



After all wins are determined in the game that WILD REEL SPIN is awarded, overlaying / cascade down all reels and may appear in any symbol position.

After the overlaying / have cascaded down the reels, all wins are determined one more time.

RANDOM WILD



After all wins are determined in the game that RANDOM WILD is awarded, extra / appears in 4 to 10 random symbol positions.

After the extra / have appeared in random symbol positions, all wins are determined one more time.

HOLD SPIN BONUS



HOLD SPIN BONUS consists of 3 free spins.

Each new BONUS symbol that appears during HOLD SPIN BONUS resets the number of remaining free spins to 3 and is held in position until HOLD SPIN BONUS ends.

After the credit prize or special credit prize is awarded, a MULTIPLIER REEL on the top screen is spun once only.

JACK'S HAUNTED WINS

FREE GAMES



Free games consists of a mini game and 8 free games. In the mini game, select 1 of 5 to reveal the number of extra added to the free games reels.

JACK'S WINNING SPELL

FREE GAMES



Free games consists of 7 free games. In each free game during the free games, from 1 to 2 randomly selected reels change to .



**MUSO™
LIMITED**

mu•so [mōō - sō] adj.
being the only one of its kind;
unlike anything else.

A stunning lighting display to attract players. Thoughtful touches to keep them comfortable.

All designed for an unparalleled 55-inch full screen dynamic gaming experience.

Distinctive LED Ambience

Unique visual experience not replicated in the market. Muso Limited creates a stunning light display with its never before seen 360-degree LED backlighting.

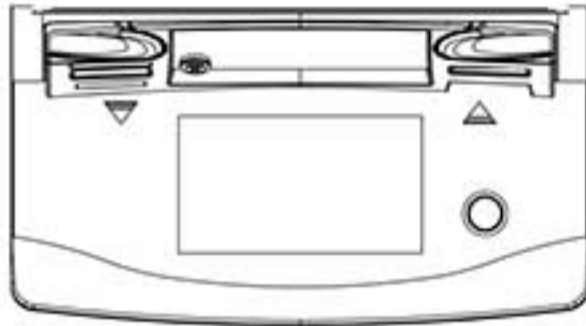

Ergonomic button deck

Inviting wrist rest and expansive glass table. Completely new interface design displayed on a 338-mm (13.3-inch) LCD deck.



USB charging

USB charging port & panel also provided for player convenience.

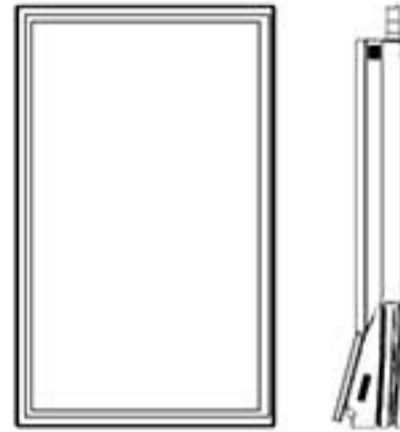
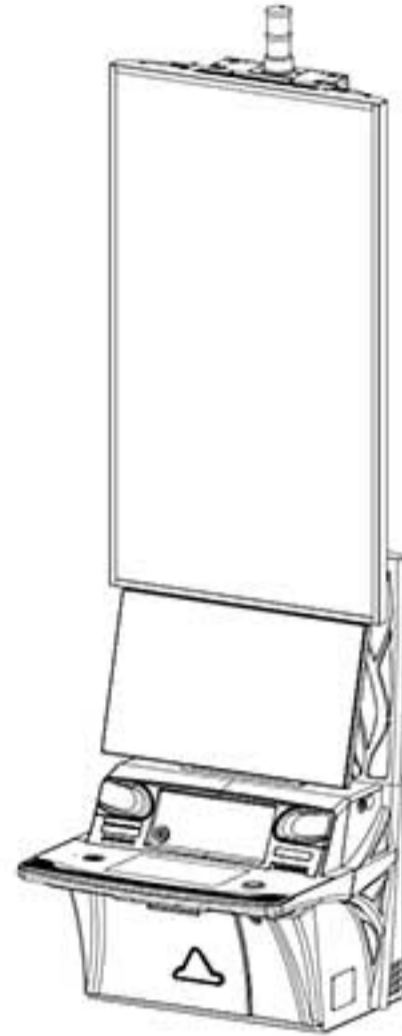

Stunning HD Graphics

An LCD monitor with a 27-inch LCD monitor and breathtaking images on a vertical 55-inch LCD monitor.

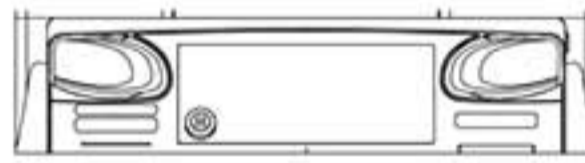

Amp up the gaming experience

Newly designed sound system creates powerful theater-like sound.

DIMENSIONS

**4 UNITS
(Without Signage)**

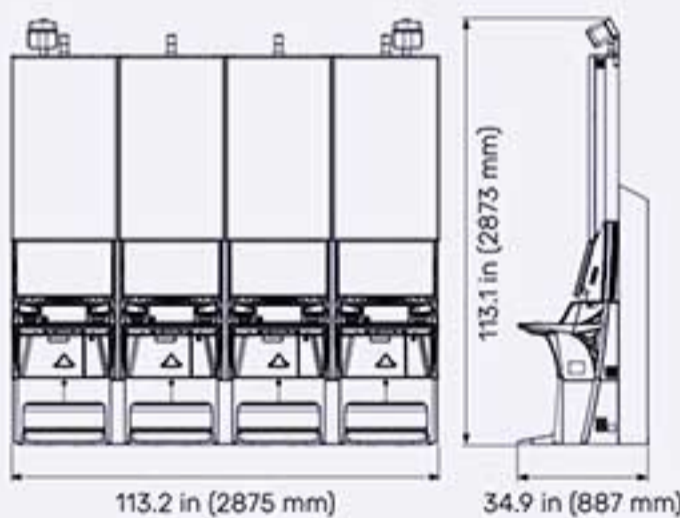

**4 UNITS
(With Signage)**

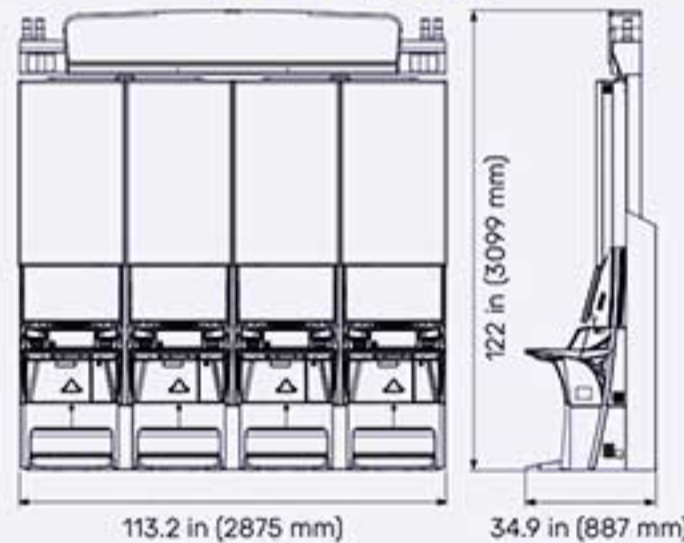

**6 UNITS
(Without Signage)**

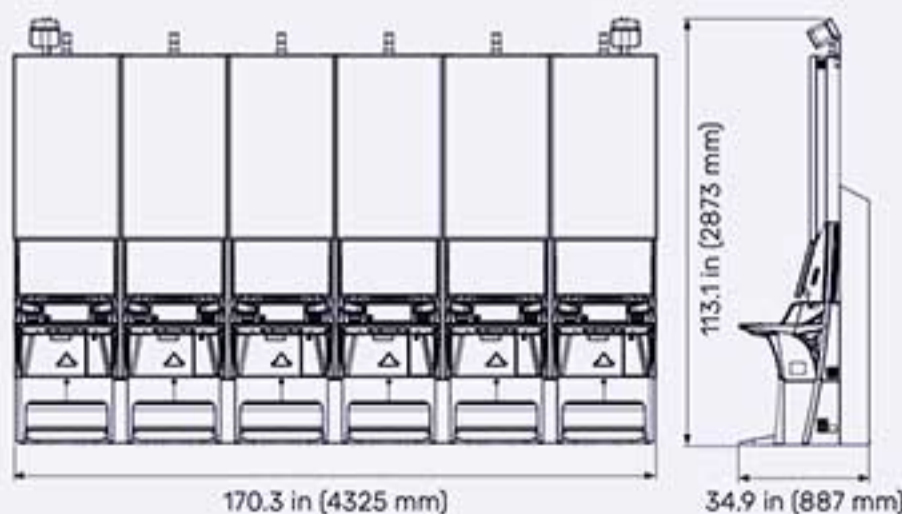

**6 UNITS
(With Signage)**

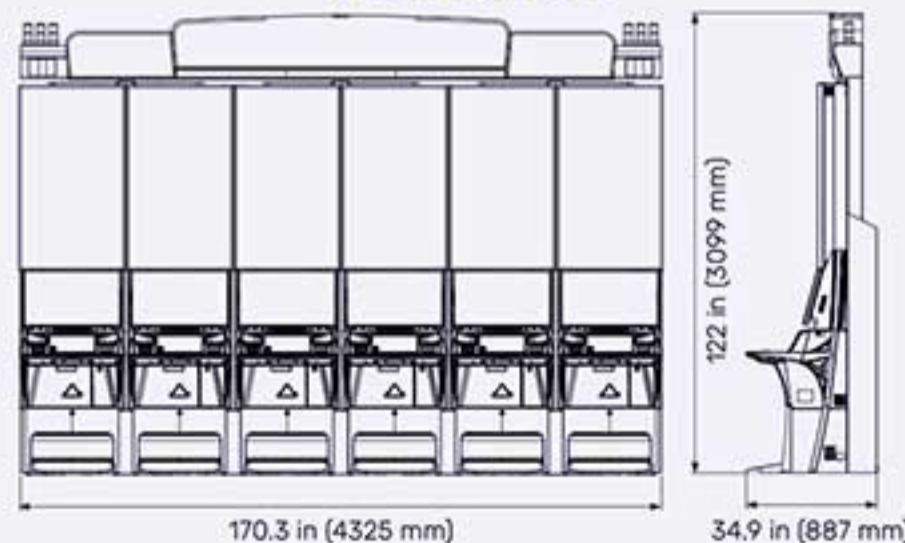

DRAGONG™



\$100,000.01
\$1,000.01
\$22.52 \$13.57

10000
GRAND
20000
MINI
30000
40000
50000

\$100,000.01
\$1,000.01
\$22.53 \$13.59

30000
50000
MINI
40000

\$100,000.01
\$1,000.01
\$22.52 \$13.57

10000
MAJOR
20000

\$100,000.01
\$1,000.01
\$22.53 \$13.59

30000
50000
MINI

\$100,000.01
\$1,000.01
\$22.52 \$13.57

40000
MINOR
10000
DRAGON

\$100,000.01
\$1,000.01
\$22.53 \$13.59

20000
MINI
30000
50000

DRAGONG LION

DRAGONG PHOENIX

Spinning riches stir up excitement. Picture symbols are increased on reels according to the credits bet played. In DRAGONG, a big win awaits as either a bonus credit prize or 1 of 4 progressive levels is won.

TYPE OF FEATURES

Video Wheel / Free Game + LP

REEL CONFIGURATION

5-Reel 3-Row Video Slot

PAYLINES

243 Ways

DENOMINATIONS

1¢

BET CONFIGURATIONS

1, 2, 3, 4, 5

1, 2, 3, 5, 10

1, 2, 5, 10, 15

1, 2, 5, 10, 20

MAX BET



440, 880, 1320, 1760









DRAGONG LION



LION FEATURE

 appearing on 3 or more consecutive reels beginning with the leftmost reel trigger the LION FEATURE.

The LION FEATURE consists of a mini game and 6 free games. In the mini game, select 1 of 5  to reveal .

Different reels are used during the free games. Reels used during the free games are composed with the following symbols only: the revealed symbol from the mini game, , , , , , ,  and . During the free games,  appearing on 3 or more consecutive reels beginning with the leftmost reel award an additional 6 free games, however the mini game is not played again.

If LION FEATURE and DRAGONG are triggered in the same game, LION FEATURE starts after DRAGONG ends. If DRAGONG is triggered during free games, any remaining free games resume after DRAGONG ends.

DRAGONG PHOENIX



FREE GAMES

 appearing on 3 or more consecutive reels beginning with the leftmost reel trigger 10 free games.

Different reels are used during the free games. Free games can be triggered again during the free games.

If free games and DRAGONG are triggered in the same game, free games start after DRAGONG ends.

If DRAGONG is triggered during free games, any remaining free games resume after DRAGONG ends.

4 UNITS



6 UNITS



DRAGONG

There is a chance DRAGONG may be triggered when  appears.

Alternatively during bought games only, the top-paying symbol appearing on 3 or more consecutive reels beginning with the leftmost reel may trigger DRAGONG.

In DRAGONG, the large prize reel displayed on the screen is spun once only.

After the reel is spun, 1 prize is won as indicated by the pointer at the bottom of the reel.

Prizes displayed on the reel are from among the following available prizes.

Credit Prizes: 1000, 1200, 1500, 2000, 2500, 3000, 4000 and 5000.

Jackpots: GRAND, MAJOR, MINOR and MINI.

JIJIFU™



Game availability subject to jurisdictional approvals.

JIJIFU RAGING DRAGON

JIJIFU RAGING PHOENIX

Collecting Mystery orb with amazing chance of prizes. Feature symbols trigger collect and super collect in which all transform into higher valued orb prize. Msytery Orbs triggered can win all prizes on features which gives bigger prizes. Additionally, jackpots may be won during bought games.

TYPE OF FEATURES

Free Game + LP

REEL CONFIGURATION

5-Reel 5-Row Video Slot

PAYLINES

7 Lines

DENOMINATIONS

1c

BET CONFIGURATIONS

1, 2, 3, 4, 5, 6, 7, 8, 9, 10

MAX BET

880

(Depends on the above Bet Configurations)

4 UNITS













6 UNITS



COLLECT FEATURE







 appearing on 3 or more consecutive reels beginning with the leftmost reel trigger the COLLECT FEATURE. The triggering  becomes  and are held in position for the duration of the COLLECT FEATURE. When COLLECT FEATURE is triggered, 3 free spins are awarded. Each newly appearing  in a free spin resets the number of remaining free spins to 3 and is held in position until the COLLECT FEATURE ends. COLLECT FEATURE starts after JACKPOT WHEEL ends if triggered in the same bought game. COLLECT FEATURE ends after all awarded free spins have been played or  appears in all 25 symbol positions. Prizes displayed on  are paid one time only for held  on the reels at the end of COLLECT FEATURE only. GRAND JACKPOT is won if  appears in all 25 symbol positions.  prizes are added to the GRAND JACKPOT WIN.  prizes won at the end of the COLLECT FEATURE are added to the prizes from the game that triggered the COLLECT FEATURE.

SUPER COLLECT FEATURE





Any combination of  and  appearing on 3 or more consecutive reels beginning with the leftmost reel trigger the SUPER COLLECT FEATURE.

Before the SUPER COLLECT FEATURE starts, each of the triggering  becomes  and each of the triggering  becomes , and all are held in position until the SUPER COLLECT FEATURE ends. When SUPER COLLECT FEATURE is triggered, 3 free spins are awarded.

Each newly appearing  /  in a free spin resets the number of remaining free spins to 3 and is held in position until the SUPER COLLECT FEATURE ends. SUPER COLLECT FEATURE starts after JACKPOT WHEEL ends if triggered in the same bought game. COLLECT FEATURE ends after all awarded free spins have been played or  /  appears in all 25 symbol positions. Prizes displayed on  /  are paid one time only for held  /  on the reels at the end of SUPER COLLECT FEATURE only.

If  /  appears in all 25 symbol positions, prizes displayed on  /  are doubled and paid one time only.

 /  prizes won at the end of SUPER COLLECT FEATURE are added to the prizes from the game that triggered the SUPER COLLECT FEATURE.

JACKPOT WHEEL



There is a chance that the JACKPOT WHEEL may be triggered when 1 or more  appears in bought games only. When the JACKPOT WHEEL is triggered, a wheel appears on the screen and is spun once only. After the wheel is spun, 1 wheel segment indicated by the pointer at the top of the wheel is selected.

The wheel contains the following:

BONUSES: MINI BONUS and MINOR BONUS

JACKPOTS: MAJOR JACKPOT and GRAND JACKPOT

JACKPOT WHEEL ends after a JACKPOT or BONUS is won.

CLASS II SYSTEM OVERVIEW

Jogo Bingo Core 2 is a Class 2 solution with a complete EGM platform + Bingo Server solution + Game Runtime for quick land-based game porting of Class 3 games to the tribal Class 2 market.

Providing mathematical tools for Class 3 to Class 2 math model conversion and a rapid game development framework, JBC2 class 2 solution uncomplicates and speeds up the time to market of Class 2 variants of Class 3 game libraries.

FEATURES & BENEFITS

- Excellent Player Retention
- Performance Tested Solutions
- Easy Integration to Loyalty Programs
- Stand Out Play Synergy Slot Content in Class 2
- Legal and Regulated – compliant and certified game content
- Jackpots and Bonuses – engaging and compelling game content
- Expanded Game Library – no restrictions on what can be achieved
- Compared to other Class game content,
Class 2 usually operates with lower costs for casinos

GAMES AVAILABLE ON THE CLASS II SYSTEM*

- Super Sun Mayan Heat
- Super Sun Savannah Heat
- Wheels Go Round Bull
- Wheels Go Round Orb Legend
- Wheels Go Round Sun Dynasty
- Wheels Go Round Tiger

* Available games are Pending Approval





GOLDEN FROG BACCARAT

A commission free version of baccarat where a three-card Banker win with a total of 7 results in a Banker push.

The Player and Tie bets pay the same as standard baccarat.

Our POWER SHOE and SMRT BOARD allows casinos to eliminate dealer errors and needless keypad entries, while providing valuable gaming data for analytics and game protection.

SIDE WAGER: 8 DECKS

Jin Chan 7

Win	112,633,011,329,024	0.02533821	40	90.1353%
Lose	4,885,765,264,174,340	0.977466179	-1	-97.7466%
Total	4,998,398,275,503,360	1.000000000		-7.6113%

Koi 8

Win	172,660,763,262,976	0.034543218	25	86.3580%
Lose	4,825,737,512,240,380	0.965456782	-1	-96.5457%
Total	4,998,398,275,503,360	1.000000000		-10.1876%

Any Three Card 9 over Three Card 1

Win	28,511,182,835,712	0.005704064	150	85.5610%
Lose	4,969,887,092,667,650	0.994295936	-1	-99.4295%
Total	4,998,398,275,503,360	1.000000000		-13.8686%

Any 2 Card 9 over Two Card 7

Win	90,066,027,282,432	0.018018978	50	86.3391%
Lose	4,908,332,248,220,930	0.981981022	-1	-98.1981%
Total	4,998,398,275,503,360	1.000000000		-8.1032%

Any 8 Over 6

Win	150,358,085,283,840	0.030081253	25	75.2031%
Lose	4,848,040,190,219,520	0.969918747	-1	-96.9919%
Total	4,998,398,275,503,360	1.000000000		-21.7887%

HOW TO PLAY

All draw rules for Golden Frog Baccarat are the same as traditional baccarat.

To begin, each player may place the base game wagers and additionally place a wager on the following:

- JIN CHAN 7
- KOI 8
- 3 CARD 9 over 3 CARD 1
- NATURAL 9 over 2 CARD 7
- ANY 8 over ANY 6

(Licensee discretion to make base game wager mandatory)

Once all wagers are placed, the game is dealt following standard Baccarat rules and procedures.

Note: For no-commission baccarat games, if the Banker hand totals 7 with three cards and is higher than the Player hand, all Banker wagers push.

After the Baccarat hand is completed, all side wagers are resolved as follows.

Players win the side wagers when one of the hands equals:

OPTIONAL BETS

- JIN CHAN 7
The JIN CHAN 7 side wager pays 40 to 1 when the Banker wins with a three-card hand totaling 7
- KOI 8
The KOI 8 side wager pays 25 to 1 when the Player wins with a three-card hand totaling 8

GOLDEN BETS (When offered)

- 3 CARD 9 over 3 CARD 1
A hand total of nine comprised of three cards wins over a hand total of one comprised of three cards, the wager is paid 150 to 1
- NATURAL 9 over 2 CARD 7
A hand total of nine comprised of two cards wins over a hand total of seven comprised of two cards, the wager is paid 50 to 1
- ANY 8 over ANY 6
A hand total of eight wins over a hand total of six, the wager is paid 25 to 1

Base Game: 8 Decks

	Combination	Player (1 on 1)	Banker (1 on 1)	Tie (1 on 1)
Player	2,230,518,282,592,260	2,230,518,282,592,260	(2,230,518,282,592,260)	(2,230,518,282,592,260)
Banker	2,179,619,555,108,860	(2,179,619,555,108,860)	2,179,619,555,108,860	(2,179,619,555,108,860)
Banker Push	112,633,011,329,024	(112,633,011,329,024)	-----	(112,633,011,329,024)
Tie	475,627,426,473,216	-----	-----	3,805,019,411,785,730
Totals	4,998,398,275,503,360	(61,734,283,845,632)	(50,898,727,483,392)	(717,751,437,244,416)
	Player Return	-1.235%	-1.018%	-14.360%

All House Edges shown as a negative Player Return



make EMPIRE MULTIPLIER BLACKJACK®/BLACKJACK WAGER



PLAY & PROCEDURES

Game is dealt and played as traditional Blackjack with the above special provision and Pay Table.
 All standard Blackjack House Rules apply, including those for splitting hands and doubling down.
 Dealer hit soft 17.

ODDS PAID UP TO 4X IN PLAY OF THE GAME

When Player wins on a Dealer bust, Dealer pays up to 4X all winning Empire Multiplier Blackjack® Wager still in action.
 All Other Player wins in Empire Multiplier Blackjack®/Blackjack pay Even Money.
 Blackjack wins pay per House Rules.



**Empire Multiplier Blackjack®
 Up to two Wager on the same Blackjack Hand**

EMPIRE MULTIPLIER BLACKJACK

Player makes EITHER OR BOTH the Empire Multiplier Blackjack® Wager and/or the Blackjack Wager in any amounts within the table limits.
 Player receives two cards as the initial Blackjack Hand and Dealer two card, one face down and one face up.
 Player evaluates his Blackjack Hand.

PAYTABLE

BUST WITH 6	4:1
BUST WITH 7	3:1
BUST WITH 8	3:2
BUST WITH 9	3:2
BUST WITH J, Q, or K	1:2
BUST WITH NATURAL 10	PUSH
ANY OTHER WIN	1:1
BLACKJACK	3:2



“STEP IT UP” BLACKJACK

Players want more ways to win and “Step It Up” Blackjack gives them what they want.

Blackjack with extra bets on the dealers total – it’s easy.

Simple to understand and more fun to play!

PAYTABLE

Dealer Total	Pays
17 / 18	2 to 1
19 / 20	2 to 1
21 / 22	3 to 1
23 / 24	6 to 1
25 / 26	9 to 1

Traditional Blackjack rules apply and the dealer hits on Soft 17.

Players place the primary wager and may place a “Step it Up” wager on one or more of the side bet locations.

The player wins the “Step it Up” Blackjack side wager if they placed a wager in the betting location that corresponds with the dealer’s final card total.

Winning wagers are paid according to the pay table.



Table Game Directors love “Step it Up” Blackjack:

- Simple game with a short learning curve
- No special training required for dealers
- Easy game for Surveillance viewing
- Casinos can offer an exciting new way to play Blackjack with a higher net win per table
- Attractive payable for players, balanced with profitable house edge percentages



Vegas 6+ Hold'em Poker is a game where the player plays a 7-card hand against the dealer's 7-card hand.

Each hand consists of two distinct player/dealer hole cards and five community cards, such as the hands dealt in Texas Hold'em. However, the deck consists of only 6's through Aces and does not have any 2's through 5's (36 card deck). The hand rankings for this game do not follow traditional Texas Hold'em rankings and are as follows in descending order:

- Royal Flush
- Straight Flush (including A-6-7-8-9)
- Four-of-a-Kind
- Flush*
- Full House*
- Three-of-a-Kind*
- Straight (including A-6-7-8-9)*
- Two Pair
- One Pair
- High Card

* As highlighted, Flushes rank higher than Full Houses and 3-of-a-Kinds rank higher than Straights.

There are two optional side wagers, both are based on straight pay tables. The first optional side wager, Hole Card Bonus™, is based on the player's and dealer's initial two cards and the second, 6+ Bonus™, is based on the player's 7-card hand.

Side Wager A "Hole Card Bonus™"

This wager is optional for the player and is based on the Player's and Dealer's initial hole cards.

Hole Cards Bonus Pay Table	
Hand	Pays "to 1"
Black AA vs. Red AA	1000
AA vs. AA	250
AA	15
AK Suited	13
A with Q or J Suited	9
AK Unsuit	7
A with Q or J Unsuit	4
Any Pair	2

BASE GAME

The player makes an ANTE wager, plus one or both of the optional side wager bet(s), then two cards are dealt face down to the player and dealer. The player looks at his cards and must either FOLD or make a FLOP bet. The FLOP bet must be two times (2x) the amount of the ANTE.

Three community cards (the FLOP) are then dealt and the player may do nothing (CHECK) or make a TURN bet. The TURN bet must be exactly equal to the ANTE bet. A fourth community card is dealt (the TURN) and the player may do nothing (CHECK) or make a RIVER bet. The RIVER bet must be exactly equal to the ANTE bet. Finally, a fifth community card is dealt (the RIVER) and the player and dealer each make the best five-card hand using any combination of the five community cards and his own two initial hole cards.

If the dealer has the higher hand the player will lose all base game wagers.

If the player has the higher hand the FLOP, TURN, and RIVER bets will pay even money. Also, if the player has three 10's or higher the Ante bet will pay even money, otherwise it will PUSH.

If the player and dealer have hands of equal value the ANTE, FLOP, TURN, and RIVER bets will all PUSH.

Side Wager B "6+ Bonus™"

This wager is optional for the player and is based on the 7 cards comprised of the player's first two cards and the five community cards.

6+ Bonus Pay Table	
Hand(s)	Pays "to 1"
Royal Flush	100 to 1
Straight Flush	50 to 1
4 of a Kind	15 to 1
Flush	7 to 1
Full House	4 to 1
3 of a Kind	2 to 1

SHORT DECK VEGAS 6+ HOLD'EM

A new way to play Hold'em shorter deck.

Better Hand!

Return Summary - Main Wagers

Qualifier	Three 8's	Three 10's
Initial Wager	1	1
Average Wager	3.8380	3.8983
Average Win	3.8169	3.8649
RTP	99.45%	99.14%
RTH	0.55%	0.86%
HE per Initial Wager	2.11%	3.35%

Probability Summary - Hole Cards Bonus

Scenario	Probability
Black A-A vs Red A-A	0.0000057
A-A vs A-A	0.0000113
Player A-A	0.0095068
Player A-K, Suited	0.0063492
Player A-Q or A-J, Suited	0.0126984
Player A-K	0.0190476
Player A-Q or A-J	0.0380952
Player Pair	0.0761905
Player Frequency	16.19%
House Edge	5.21%

Probability Summary - 6+ Bonus

Player Hand	Probability
Royal Flush	0.0000223
Straight Flush	0.0001042
Four of a Kind	0.0095348
Flush	0.0021031
Full House	0.0075832
Three of a Kind	0.0076376
Pay Frequency	17.985%
House Edge	6.2245%



ARUZE
INTERACTIVE

Whether you are at home
or on the go, you can always
locate your favorite
Aruze games!



Zynga - HIT IT RICH



LUCKY NORTH CASINO



BEST BET CASINO



SUPER LUCKY CASINO



TROPWORLD CASINO



GSN - WHEEL OF FORTUNE



MAGICIAN CASINO 2



INNOVATION REBORN



Aruze Gaming Global HQ

1106 Palms Airport Dr
Las Vegas, NV 89119
TEL: +1 702-781-8080
EMAIL: info@aruzeglobal.com

Aruze Gaming Global Central Office

10447 Lemoyne Blvd
Biloxi, MS 39532
TEL: +1 702-781-8080

Customer Technical Support

Available 24 hours a day / 7 days a week
TEL: +1 877-438-0569
EMAIL: service@aruzeglobal.com

Empire Technological Group Japan K.K

2-21-6, Kandamisakicho Gaia Force Building 2F,
Chiyoda-ku, Tokyo, 101-0061 Japan

Empire Shared Services Philippines, Inc.

Ayala Tower One 1105-1106, 6767 Ayala Avenue
Corner Paseo de Roxas, Makati, Philippines

Aruze Gaming Africa PTY LTD.

P.O. Box 11484, Vorna Valley 1684 Unit 1/2/3 Kyalami
Village 57 Forrsman Close, Barbeque D owns Ext. 1
Kyalami, Midrand, Gauteng, South Africa
TEL: +27 11-466-3388 FAX: +27 11-466-3389

Aruze Gaming Australia PTY LTD.

Unit 6, 463 Victoria Street, Wetherill Park,
NSW 2164, Australia
TEL: +61 2-8332-6000
EMAIL: sales@aruzegaming.com.au

Empire Technological Group Limited - Macau Branch

Avenida Xian Xing Hai, Centro Golden Dragon,
11 Andar N, Macau

CONFIDENTIAL

For Aruze Customer's Internal use only
Do Not Otherwise Reproduce or Disclose

Follow us @AruzeGaming



www.aruzeglobal.com