



**ARUZE**GAMING<sup>®</sup>  
GLOBAL

# LEGACY REBORN

ICE 2024 | Product Catalog







# CONTENTS

## MUSO CURVE-55 HYBRID, MUSO CURVE-43 and MUSO CURVE-43 HYBRID

---

MUSO CURVE-55 Hybrid (Cabinet Feature)	5
MUSO CURVE-43 (Cabinet Feature)	6
MUSO CURVE-43 Hybrid (Cabinet Feature)	7
X Wheel Supreme Series	8
X Wheel Supreme God	9
X Wheel Supreme Dragon	10
Gong Cash Series	11
Gong Cash Dragon	12
Gong Cash Lion	13
Firestorm Series	14
Firestorm Bull	15
Firestorm Lion	16
Gong Gong Lai Fu Series	17
Gong Gong Lai Fu Caishen Riches	18
Gong Gong Lai Fu Mighty Buddha	19
Fu Lai Cai Lai Fortune Series	20
Fu Lai Cai Lai Fortune 5 Sea Legends	21
Fu Lai Cai Lai Fortune Triple Festival	22
Fu Lai Cai Lai Fortune Stack Wild Luxury	23
God of Winning Series	24
God of Winning Great Hammer	25
God of Winning Super Spear	26
Triple Treasure Pot Series	27
Triple Treasure Pot Heavenly Wealth	28
Triple Treasure Pot Eternal Prosperity	29
Long Fu Zhu Series	30
Long Fu Zhu Mongol Storm	31
Long Fu Zhu Panda Strike	32

## MUSO TRIPLE-32 HYBRID

---

MUSO TRIPLE-32 Hybrid (Cabinet Feature)	33
Bomb Collector Series	34
Bomb Collector Gold Heist	35
Bomb Collector Treasure Heist	36
Diamond Pays Series	37
Diamond Pays Oriental Princess	38
Diamond Pays Arabian Oasis	39
Fortune Frame Series	40
Fortune Frame Dragon Bounty	41
Fortune Frame Panda Carnival	42
Dancing Panda Supreme Series	43
Dancing Panda Supreme Festival	44
Dancing Panda Supreme Fortune	45
Tomb Treasure Series	46
Tomb Treasure Cleopatra Legend	47
Tomb Treasure Pharaoh Gold	48
Tomb Treasure Sphinx Gold	49

## SPEED

---

SPEED (Cabinet Feature)	50
Orb of Wealth Series	51
Orb of Wealth Mythic Beasts	52
Orb of Wealth Shining Fortune	53

Bound For Riches Series	54
Bound For Riches Aztec Legend	55
Bound For Riches Chinese Celebration	55
Bound For Riches Egyptian Majesty	55
Bound For Riches Spanish Matador	55
Co Co Coin Series	56
Co Co Coin Egyptian Treasure	57
Co Co Coin Pirates Treasure	58
Dancing Panda Series	59
Dancing Panda Fortune	60
Dancing Panda Festival	61
Fu Lai Cai Lai Series	62
Fu Lai Cai Lai 5 Sea Legends	63
Fu Lai Cai Lai Triple Festival	63
Fu Lai Cai Lai Stack Wild Luxury	63
Fortune Drums Series	64
Fortune Drums Dragon Boat	65
Fortune Drums Zodiac Beasts	65
Fortune Drums Bag of Wealth	66
Fortune Drums Chinese Luxury	66
Coin Collector Series	67
Coin Collector 5 Guardians	68
Coin Collector Aussie 5	68
Sunlight Series	69
Sunlight Savanna 5	70
Sunlight Joyful Lion	70
Jack's Series	71
Jack's Haunted Wins	72
Jack's Winning Spell	72

## LPM

---

Lucky Big 5	74
Egyptian Majesty	75
Fortune Mystery Leprechaun	76
Fortune Mystery Leonidas	77

## CLASS 2 GAMES

---

Class 2 System Overview	78
-------------------------	----

## TABLE GAMES

---

Golden Frog Baccarat	79
Empire Multiplier Blackjack	80
Step it up Blackjack	81
Short Deck Vegas 6+ Hold'em	82
Mensa Progressive Technology for Poker	83

## iGAMING

---

iGAMING	84 - 85
---------	---------

## JOYRIDE JACKPOT

---

Joyride Jackpot	86 - 87
-----------------	---------



**MUSO™**  
CURVE-55HB

mu·so [ mōō - sō ] *adj.*  
being the only one of its kind;  
unlike anything else.



New Face

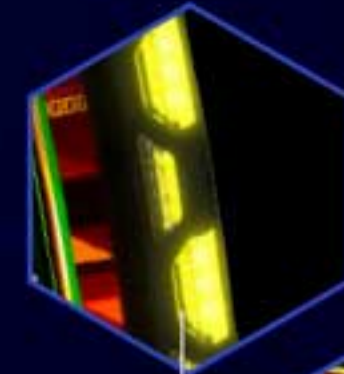

New honeycomb LED (Details)



New vertical 55-inch J-Style curved LCD monitor

A stunning new honeycomb cabinet LED display to attract players.

Thoughtful touches to keep them comfortable.

All designed for an unparalleled 55-inch full screen dynamic gaming experience.

**BUILT FOR EXCELLENCE**

**DIMENSION**

**Upright Height (Tower Light Included)**  
108.3 in (2756.9 mm)

**Upright Height (Tower Light Excluded)**  
104.4 in (2652.5 mm)

**Width**  
31.9 in (810 mm)

**Depth**  
33 in (838.2 mm)

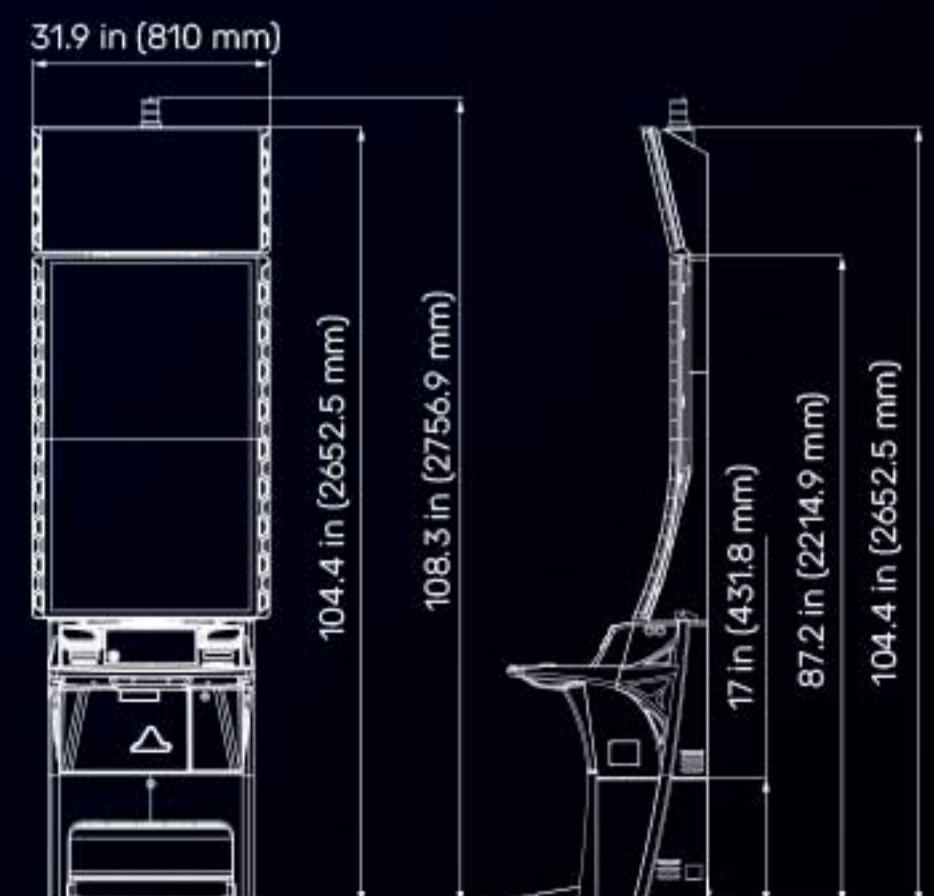
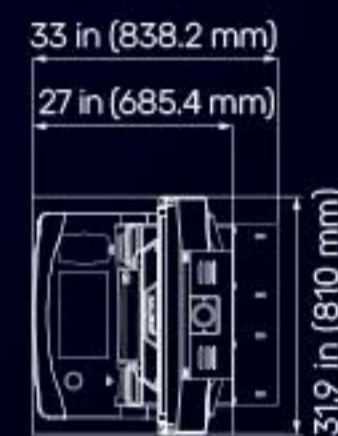

A stunning lighting display to attract players.  
Thoughtful touches to keep them comfortable.  
All designed for an unparalleled gaming experience.

**Distinctive LED Ambience**

Unique visual experience not replicated in the market. Muso Curve-43 creates a stunning light display with its never before seen 360-degree LED backlighting.

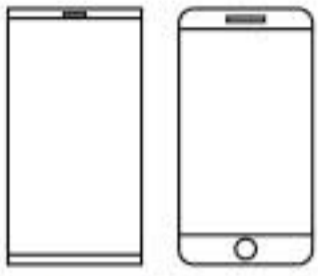

**USB charging**

USB charging port & panel also provided for player convenience.

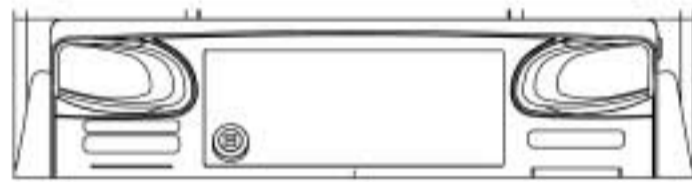

**Amp up the gaming experience**

Newly designed sound system creates powerful theater-like sound.

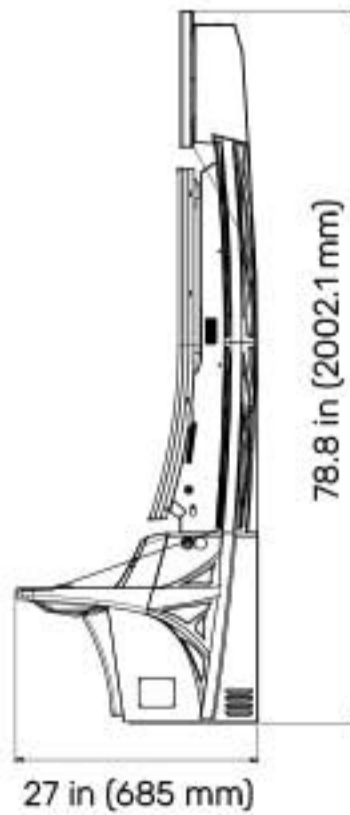
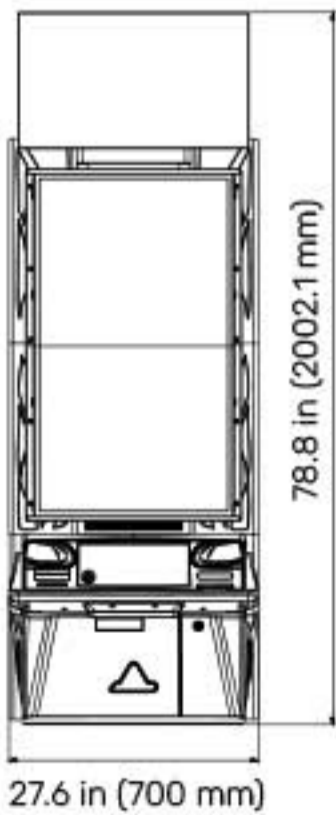

**Stunning HD Graphics**

An LCD monitor with a 27-inch LCD monitor topper. Breathtaking images on a vertical 43-inch J-style curved.

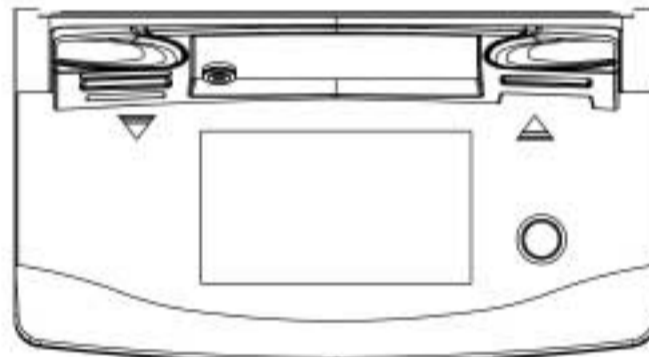

**Ergonomic button deck**

Inviting wrist rest and expansive glass table. Completely new interface design displayed on a 338-mm (13.3-inch) LCD deck.

**DIMENSION**

**Height**

78.8 in (2002.1 mm)\*

**Width**

27.6 in (700 mm)

**Depth**

27 in (685 mm)

*\*Height of the tower light not included.*



**MUSO™  
CURVE-43**

**mu•so [ mōō - sō ] adj.**

being the only one of its kind;  
unlike anything else.



**BUILT FOR EXCELLENCE**



**MUSO™**  
CURVE-43HB

**mu·so [ mōō - sō ] adj.**

being the only one of its kind;  
unlike anything else.

**Distinctive LED Ambience**

Unique visual experience not replicated in the market, Muso Curve-43 HB creates a stunning light display with its never before seen 360-degree LED backlighting.

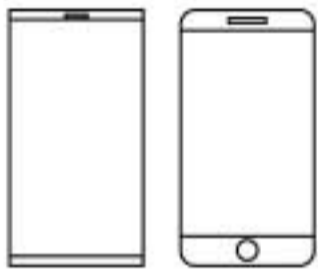

**USB charging**

USB charging port & panel also provided for player convenience.

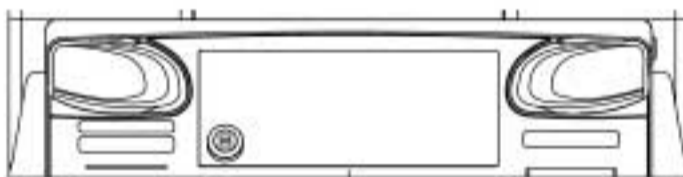

**Amp up the gaming experience**

Newly designed sound system creates powerful theater-like sound.

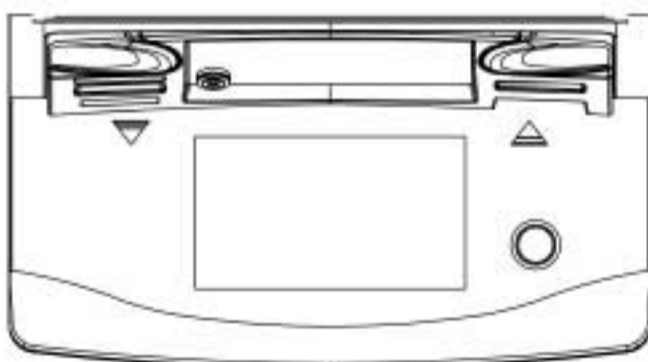

**Ergonomic button deck**

Inviting wrist rest and expansive glass table. Completely new interface design displayed on a 338-mm (13.3-inch) LCD deck.

A stunning lighting display to attract players.

Thoughtful touches to keep them comfortable.

All designed for an unparalleled 43-inch full screen dynamic gaming experience.



**Stunning HD Graphics**

An LCD monitor with a 27-inch LCD monitor topper. Breathtaking images on a vertical 43-inch J-style curved.

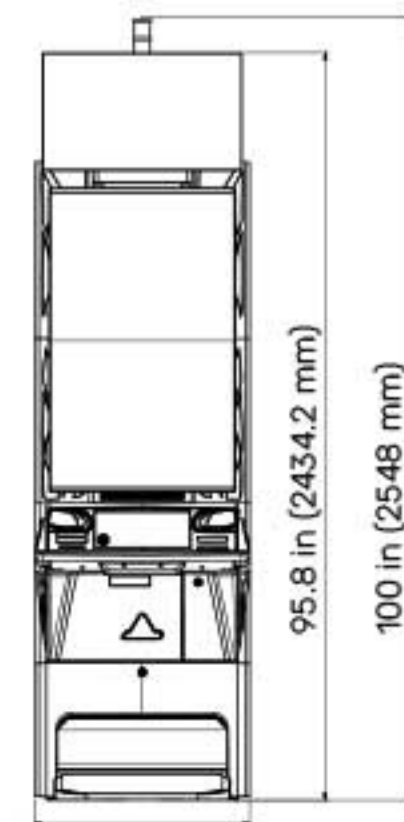
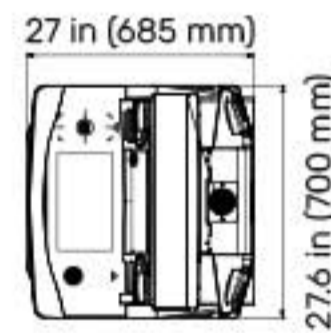

27.6 in (700 mm)

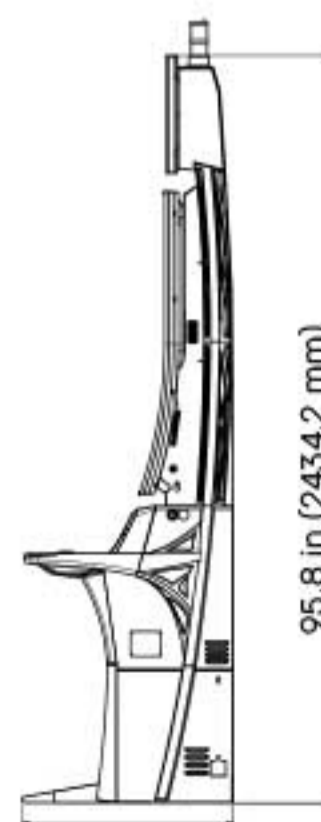

27 in (685 mm)



**DIMENSION**

**Upright Height (Tower Light Included)**  
100 in (2548 mm)

**Upright Height (Tower Light Excluded)**  
95.8 in (2434.2 mm)

**Width**  
27.6 in (700 mm)

**Depth**  
27 in (685 mm)

**BUILT FOR EXCELLENCE**

# X WHEEL SUPREME™ X WHEEL SUPREME™

## GOD DRAGON

**X WHEEL SUPREME™  
GOD**

<b>GRAND</b>	<b>\$5,000.01</b>
<b>MAJOR</b>	<b>\$500.02</b>
<b>MINOR</b>	<b>\$25.03</b>
<b>MINI</b>	<b>\$10.07</b>

**X WHEEL SUPREME™  
DRAGON**

<b>GRAND</b>	<b>\$5,000.01</b>
<b>MAJOR</b>	<b>\$500.02</b>
<b>MINOR</b>	<b>\$25.04</b>
<b>MINI</b>	<b>\$10.08</b>

Wheel of Fortune for X Wheel Supreme God. The wheel is divided into 20 segments with numbers 1-20. A lion's head is in the center. Below the wheel is a 5x3 slot machine grid with symbols including J, K, Q, WILD, and 9.

Wheel of Fortune for X Wheel Supreme Dragon. The wheel is divided into 20 segments with numbers 1-20. A dragon's head is in the center. Below the wheel is a 5x3 slot machine grid with symbols including J, J, Q, WILD, and K.







Extra reel spins increase collected wins multiplied by a wheel spin. Scattered bonus symbols trigger a collect feature in which all prizes on collected bonus symbols contribute to a bonus prize total multiplied by a wheel-selected multiplier. Look for special bonus symbols to appear in the collect feature that add additional spins resulting in more chances to increase the bonus prize total. There is also a chance to win a wheel-selected jackpot when wild symbols appear in bought games.

**CASH SPIN FEATURE, BONUS PRIZE METER and MULTIPLIER WHEEL**

Any 3 or more trigger the CASH SPIN FEATURE. When the CASH SPIN FEATURE is triggered, 3 free spins are awarded. The PRIZE AMOUNT displayed on any appearing in a free spin is added to the BONUS PRIZE meter.



Each appearing in a free spin awards 1 additional free spin.

If 1 or more appear during any free spin, at the end of the CASH SPIN FEATURE the MULTIPLIER WHEEL is spun once to award a multiplier that is applied to the BONUS PRIZE total which is then won.

During the CASH SPIN FEATURE, the BONUS PRIZE meter is displayed at the center of the MULTIPLIER WHEEL. The MULTIPLIER WHEEL is spun once at the end of the CASH SPIN FEATURE to award a multiplier that applies to the BONUS PRIZE total.

After the MULTIPLIER WHEEL is spun, 1 multiplier is awarded as indicated by the pointer at the top of the wheel. The MULTIPLIER WHEEL contains the following multipliers: 2x, 3x, 4x, 5x, 7x, 8x, 10x, 12x, 15x and 20x.

**JACKPOT WHEEL**



There is a chance that the JACKPOT WHEEL may be triggered when 1 or more appear.

After the wheel is spun, 1 jackpot is awarded as indicated by the pointer at the top of the wheel.

The JACKPOT WHEEL contains the following:

- 4 JACKPOT LEVELS: GRAND, MAJOR, MINOR and MINI.



**TYPE OF FEATURES**

Video Wheel / Free Game + LP

**REEL CONFIGURATION**

5-Reel 3-Row Video Slot

**PAYLINES**

30 Lines

**DENOMINATIONS**

R0.10

€0.01

**BET CONFIGURATIONS**

1, 2, 3, 4, 5, 6, 7, 8, 9, 10

**MIN/MAX BET**



75 Bet up to 750 Bet

(Depends on the above Bet Configurations)



Extra reel spins increase collected wins multiplied by a wheel spin. Scattered bonus symbols trigger a collect feature in which all prizes on collected bonus symbols contribute to a bonus prize total multiplied by a wheel-selected multiplier. Look for special bonus symbols to appear in the collect feature that add additional spins resulting in more chances to increase the bonus prize total. There is also a chance to win a wheel-selected jackpot when wild symbols appear in bought games.

#### CASH SPIN FEATURE, BONUS PRIZE METER and MULTIPLIER WHEEL

Any 3 or more  trigger the CASH SPIN FEATURE. When the CASH SPIN FEATURE is triggered, 3 free spins are awarded. The PRIZE AMOUNT displayed on any  appearing in a free spin is added to the BONUS PRIZE meter.



Each  appearing in a free spin awards 1 additional free spin.

If 1 or more  appear during any free spin, at the end of the CASH SPIN FEATURE the MULTIPLIER WHEEL is spun once to award a multiplier that is applied to the BONUS PRIZE total which is then won.

During the CASH SPIN FEATURE, the BONUS PRIZE meter is displayed at the center of the MULTIPLIER WHEEL. The MULTIPLIER WHEEL is spun once at the end of the CASH SPIN FEATURE to award a multiplier that applies to the BONUS PRIZE total.

After the MULTIPLIER WHEEL is spun, 1 multiplier is awarded as indicated by the pointer at the top of the wheel. The MULTIPLIER WHEEL contains the following multipliers: 2x, 3x, 4x, 5x, 7x, 8x, 10x, 12x, 15x and 20x.

#### JACKPOT WHEEL



There is a chance that the JACKPOT WHEEL may be triggered when 1 or more  appear.

After the wheel is spun, 1 jackpot is awarded as indicated by the pointer at the top of the wheel.

The JACKPOT WHEEL contains the following:

- 4 JACKPOT LEVELS: GRAND, MAJOR, MINOR and MINI.

#### TYPE OF FEATURES

Video Wheel / Free Game + LP

#### REEL CONFIGURATION

5-Reel 3-Row Video Slot

#### PAYLINES

30 Lines

#### DENOMINATIONS

SA R0.10

EU €0.01

#### BET CONFIGURATIONS

1, 2, 3, 4, 5, 6, 7, 8, 9, 10

#### MIN/MAX BET

75 Bet up to 750 Bet

(Depends on the above Bet Configurations)

# GONG CASH™ DRAGON

# GONG CASH™ LION

**GRAND**  
**\$2,500.01**

**MAJOR**  
**\$250.01**

**MINOR**    **MINI**  
\$20.03    \$10.04

**GRAND**  
**\$2,500.01**

**MAJOR**  
**\$250.01**

**MINOR**    **MINI**  
\$20.03    \$10.05

**GONG CASH™  
DRAGON**

**GONG CASH™  
LION**

1c    CREDIT 912    BET 88    WIN 0

**GONG CASH™  
LION**

1c    CREDIT 912    BET 88    WIN 0



Fortunes abound with overflowing pots of gold coins in this exciting theme. With mystery symbols that randomly change and surprise bonuses, riches may be just one spin away. Special scatters add to the fun and can trigger even more free spins & prizes.

### GONG SPIN FEATURE



3 scattered  appearing on reels 2, 3 and 4 trigger the GONG SPIN FEATURE.

When the GONG SPIN FEATURE is triggered, 3 free spins are awarded.

Each newly appearing  displaying "+1 SPIN" in a free spin awards 1 additional free spin.

GONG SPIN FEATURE ends after all awarded free spins have been played.

### JACKPOT FEATURE



There is a chance that the JACKPOT FEATURE may be triggered when 1 or more  appears in bought games only.

In the JACKPOT FEATURE, select from 12 icons until 3 matching symbols corresponding to a JACKPOT level are revealed.

When 3 matching JACKPOT level symbols have been revealed, the corresponding JACKPOT level is won and the JACKPOT FEATURE ends. The chances of revealing each jackpot symbol are not equal.

A JACKPOT level is reset to its initial value each time that JACKPOT level is won.

JACKPOT FEATURE and GONG SPIN FEATURE cannot be triggered in the same game.

### TYPE OF FEATURES

Free Game + LP

### REEL CONFIGURATION

5-Reel 3-Row Video Slot

### PAYLINES

243 Ways

### DENOMINATIONS

SA R0.10

EU €0.01

### BET CONFIGURATIONS

1, 2, 3, 4, 5, 6, 7, 8, 9, 10

### MIN/MAX BET

88 up to 880

(Depends on the above Bet Configurations)



Fortunes abound with overflowing pots of gold coins in this exciting theme. With mystery symbols that randomly change and surprise bonuses, riches may be just one spin away. Special scatters add to the fun and can trigger even more free spins & prizes.

**GONG SPIN FEATURE**



3 scattered appearing on reels 2, 3 and 4 trigger the GONG SPIN FEATURE.

When the GONG SPIN FEATURE is triggered, 3 free spins are awarded.

Each newly appearing displaying "+1 SPIN" in a free spin awards 1 additional free spin.

GONG SPIN FEATURE ends after all awarded free spins have been played.

**JACKPOT FEATURE**



There is a chance that the JACKPOT FEATURE may be triggered when 1 or more appears in bought games only.

In the JACKPOT FEATURE, select from 12 icons until 3 matching symbols corresponding to a JACKPOT level are revealed.

When 3 matching JACKPOT level symbols have been revealed, the corresponding JACKPOT level is won and the JACKPOT FEATURE ends. The chances of revealing each jackpot symbol are not equal.

A JACKPOT level is reset to its initial value each time that JACKPOT level is won.

JACKPOT FEATURE and GONG SPIN FEATURE cannot be triggered in the same game.



**TYPE OF FEATURES**

Free Game + LP

**REEL CONFIGURATION**

5-Reel 3-Row Video Slot

**PAYLINES**

243 Ways

**DENOMINATIONS**

**SA** R0.10

**EU** €0.01

**BET CONFIGURATIONS**

1, 2, 3, 4, 5, 6, 7, 8, 9, 10

**MIN/MAX BET**

88 up to 880

(Depends on the above Bet Configurations)

# FIRESTORM™ BULL

# FIRESTORM™ LION





Special fireball symbols award blazing prizes. Transforming symbols in bought games and free games all become the same symbol. The number of free games awarded is the sum of the numbers appearing on each triggering feature symbol. Special scatters can trigger a collect feature in which all prizes displayed on the collected scatters are won, including bonuses and jackpots. Special symbols can unlock additional symbol rows during the collect feature bringing even more blazing wins. Additionally, jackpots can be won randomly during bought games.



### FREE GAMES FEATURE

appearing on 3 or more consecutive reels beginning with the leftmost reel trigger the free games feature.

The sum of the numbers that appeared is awarded as FREE GAMES in the FREE GAMES FEATURE. When the FREE GAMES FEATURE is triggered, a number appears on each that was involved in triggering the feature. 1, 2, 3, 5, 7 or 10 free games are awarded for each .

If RISING FIRE is triggered during the FREE GAMES FEATURE, any remaining free games resume after RISING FIRE ends.



### MYSTERY SYMBOL

During bought games, appearing on the reels changes to . **A, K, Q, J, 10** or **9** after all reels finish spinning.

During FREE GAMES FEATURE, appearing on the reels changes to or after all reels finish spinning.

All appearing in the same game randomly change to the same symbol. If appears, wins are determined after finishes changing.



### RISING FIRE

Any 6 or more / in a bought game or free game trigger RISING FIRE. During RISING FIRE, all symbol positions become individual spinning bonus reels. Any that trigger RISING FIRE or appear during RISING FIRE are held for the duration of RISING FIRE. Any that trigger RISING FIRE or appear during RISING FIRE decrease the remaining number of needed to unlock bonus symbol rows and decrease the number of remaining needed to win the UP UP JACKPOT. When RISING FIRE is triggered, 3 free spins are awarded. Each newly appearing / in a free spin resets the number of remaining free spins to 3.

RISING FIRE ends after all awarded free spins have been played or if fills every symbol position. Any unlocked bonus symbol row is locked again after RISING FIRE ends. The number of remaining required to unlock any bonus symbol row is reset after RISING FIRE ends. The number of remaining required to win the UP UP JACKPOT is reset after RISING FIRE ends.



### JACKPOT SURPRISE RISING FIRE

There is a chance that 1 JACKPOT is randomly won in bought games except when FREE GAMES FEATURE or RISING FIRE is triggered.



### TYPE OF FEATURES

Free Game + LP

### REEL CONFIGURATION

5-Reel 4-Row Video Slot  
(Up to 10 rows during RISING FIRE)

### PAYLINES

50 Lines

### DENOMINATIONS

SA				
1	2	3	4	5
R0.01	R0.02	R0.05	R0.10	R0.20
R0.05	R0.10	R0.25	R0.50	R1
R0.10	R0.20	R0.50	R1	R2
R0.50	R1	R2.50	R5	R10
R1	R2	R5	R10	R20

EU				
1	2	3	4	5
€0.01	€0.02	€0.05	€0.10	€0.20
€0.05	€0.10	€0.25	€0.50	€1
€0.10	€0.20	€0.50	€1	€2
€0.50	€1	€2.50	€5	€10
€1	€2	€5	€10	€20

### BET CONFIGURATIONS

1, 2, 3, 4, 5, 8, 10

### MIN/MAX BET

75 Bet up to 975 Bet

(Depends on the above Bet Configurations)



Special fireball symbols award blazing prizes. Transforming symbols in bought games and free games all become the same symbol. The number of free games awarded is the sum of the numbers appearing on each triggering feature symbol. Special scatters can trigger a collect feature in which all prizes displayed on the collected scatters are won, including bonuses and jackpots. Special symbols can unlock additional symbol rows during the collect feature bringing even more blazing wins. Additionally, jackpots can be won randomly during bought games.

**TYPE OF FEATURES**

Free Game + LP

**REEL CONFIGURATION**

5-Reel 4-Row Video Slot  
(Up to 10 rows during RISING FIRE)

**PAYLINES**

50 Lines

**DENOMINATIONS**

**SA**

1	2	3	4	5
R0.01	R0.02	R0.05	R0.10	R0.20
R0.05	R0.10	R0.25	R0.50	R1
R0.10	R0.20	R0.50	R1	R2
R0.50	R1	R2.50	R5	R10
R1	R2	R5	R10	R20

**EU**

1	2	3	4	5
€0.01	€0.02	€0.05	€0.10	€0.20
€0.05	€0.10	€0.25	€0.50	€1
€0.10	€0.20	€0.50	€1	€2
€0.50	€1	€2.50	€5	€10
€1	€2	€5	€10	€20

**BET CONFIGURATIONS**

1, 2, 3, 4, 5, 8, 10

**MIN/MAX BET**

75 Bet up to 975 Bet  
(Depends on the above Bet Configurations)



**FREE GAMES FEATURE**

appearing on 3 or more consecutive reels beginning with the leftmost reel trigger the FREE GAMES FEATURE. When the FREE GAMES FEATURE is triggered, a number appears on each that was involved in triggering the feature. 1, 2, 3, 5, 7 or 10 free games are awarded for each . The sum of the numbers that appeared is awarded as FREE GAMES in the FREE GAMES FEATURE. FREE GAMES FEATURE can be triggered again during the FREE GAMES FEATURE. FREE GAMES FEATURE starts after RISING FIRE ends if triggered in the same game. If RISING FIRE is triggered during the FREE GAMES FEATURE, any remaining free games resume after RISING FIRE ends.



**MYSTERY SYMBOL**

appearing on the reels changes to , , or . A, K, Q, J, 10 or 9 after all reels finish spinning. All appearing in the same game randomly change to the same symbol. If appears, wins are determined after finishes changing. Does not appear during RISING FIRE.



**RISING FIRE**

Any 6 or more / in a bought game or free game trigger RISING FIRE. During RISING FIRE, all symbol positions become individual spinning bonus reels. Any that trigger RISING FIRE or appear during RISING FIRE are held for the duration of RISING FIRE. Any that trigger RISING FIRE or appear during RISING FIRE decrease the remaining number of needed to unlock bonus symbol rows and decrease the number of remaining needed to win the UP UP JACKPOT. When RISING FIRE is triggered, 3 free spins are awarded. Each newly appearing / in a free spin resets the number of remaining free spins to 3. RISING FIRE ends after all awarded free spins have been played or if fills every symbol position. Any unlocked bonus symbol row is locked again after RISING FIRE ends. The number of remaining required to unlock any bonus symbol row is reset after RISING FIRE ends. The number of remaining required to win the UP UP JACKPOT is reset after RISING FIRE ends.



**JACKPOT SURPRISE RISING FIRE**

There is a chance that 1 JACKPOT is randomly won in bought games except when FREE GAMES FEATURE or RISING FIRE is triggered.



# GONGGONG LAIFU™

CAISHEN RICHES

MIGHTY BUDDHA





The sound of the Gong brings good fortune. A new set of reels will appear during Gong Gong Lai Fu Feature, awarding Credit prizes or Bonuses. Each Gong symbol appearing is held for the entire Feature and adds to the prizes shown on top of the reels. Grand Jackpot can be won when all 15 Gong symbol are collected during Gong Gong Lai Fu Feature or as Jackpot Surprise during the bought games.

### FREE GAMES FEATURE



Any 3 Gong symbols appearing on reels 2, 3 and 4 trigger the FREE GAMES FEATURE with 8 free games.

Reels used during the FREE GAMES FEATURE contain a greater total number of Gong symbols.

FREE GAMES FEATURE can be triggered again during the FREE GAMES FEATURE.

FREE GAMES FEATURE starts after the GONG GONG LAI FU FEATURE ends if triggered in the same game.

If GONG GONG LAI FU FEATURE is triggered during the FREE GAMES FEATURE, any remaining free games resume after the GONG GONG LAI FU FEATURE ends.

### GONG GONG LAI FU FEATURE



Any 6 or more Gong symbols trigger the GONG GONG LAI FU FEATURE and are held in position on the reels for the duration of the GONG GONG LAI FU FEATURE.

GONG GONG LAI FU FEATURE consists of 3 free spins.

During the GONG GONG LAI FU FEATURE, each symbol position becomes an individual spinning bonus reel.

In the GONG GONG LAI FU FEATURE, a prize map corresponding to the 15 symbol positions on the reels is displayed above the reels. Before the first free spin, each Gong symbol on the reels displays the prize from the corresponding location on the prize map. While a Gong symbol is held on the reels, the prize in the corresponding location on the prize map is also held. At the start of each free spin in GONG GONG LAI FU FEATURE, displayed prizes are redetermined for prize map squares that do not contain a held prize. Each new Gong symbol appearing in a free spin displays a prize value that it is the sum of all held prizes displayed on the prize map from the previous free spin within the same GONG GONG LAI FU FEATURE only. Each new Gong symbol appearing in a free spin resets the number of remaining free spins to 3 and is held in position for the duration of the GONG GONG LAI FU FEATURE. GONG GONG LAI FU FEATURE ends after all awarded free spins have been played or if Gong symbols appear in all 15 symbol positions. All prizes on Gong symbols are won at the end of feature.

### JACKPOT SURPRISE



There is a chance that the GRAND JACKPOT is randomly won in bought games except when FREE GAMES FEATURE or GONG GONG LAI FU FEATURE is triggered.

### TYPE OF FEATURES

Free Game + LP

### REEL CONFIGURATION

5-Reel 3-Row Video Slot

### PAYLINES

10, 25, 50 Lines (Denomination 1, 2)  
5, 10, 25 Lines (Denomination 3, 4, 5)  
5 Lines (Denomination 6, 7, 8)

### DENOMINATIONS

#### SA

1	2	3	4	5	6	7	8
R0.01	R0.02	R0.05	R0.10	R0.20	R1	R2	R5
R0.05	R0.10	R0.25	R0.50	R1	R5	R10	R25
R0.10	R0.20	R0.50	R1	R2	R10	R20	R50
R0.50	R1	R2.50	R5	R10	R50	R100	R250
R1	R2	R5	R10	R20	R100	R200	R500

#### EU

1	2	3	4	5	6	7	8
€0.01	€0.02	€0.05	€0.10	€0.20	€1	€2	€5
€0.05	€0.10	€0.25	€0.50	€1	€5	€10	€25
€0.10	€0.20	€0.50	€1	€2	€10	€20	€50
€0.50	€1	€2.50	€5	€10	€50	€100	€250
€1	€2	€5	€10	€20	€100	€200	€500

### BET CONFIGURATIONS

1, 2, 3, 4, 5  
1, 2, 3, 5, 8  
1, 2, 3, 5, 10  
1, 2, 5, 10, 20

### MAX BET

250, 400, 500, 1000 (Denomination 1, 2)  
125, 200, 250, 500 (Denomination 3, 4, 5)  
25, 40, 50, 100 (Denomination 6, 7, 8)



The sound of the Gong brings good fortune. A new set of reels will appear during Gong Gong Lai Fu Feature, awarding Credit prizes or Bonuses. Each Gong symbol appearing is held for the entire Feature and adds to the prizes shown on top of the reels. Grand Jackpot can be won when all 15 Gong symbol are collected during Gong Gong Lai Fu Feature or as Jackpot Surprise during the bought games.

**FREE GAMES FEATURE**



Any 3 appearing on reels 2, 3 and 4 trigger the FREE GAMES FEATURE with 6 free games. Reels used during the FREE GAMES FEATURE contain a greater total number of and . FREE GAMES FEATURE can be triggered again during the FREE GAMES FEATURE. FREE GAMES FEATURE starts after the GONG GONG LAI FU FEATURE ends if triggered in the same game. If GONG GONG LAI FU FEATURE is triggered during the FREE GAMES FEATURE, any remaining free games resume after the GONG GONG LAI FU FEATURE ends.

**GONG GONG LAI FU FEATURE**



Any 6 or more trigger the GONG GONG LAI FU FEATURE and are held in position on the reels for the duration of the GONG GONG LAI FU FEATURE. GONG GONG LAI FU FEATURE consists of 3 free spins. During the GONG GONG LAI FU FEATURE, each symbol position becomes an individual spinning bonus reel.

In the GONG GONG LAI FU FEATURE, a prize map corresponding to the 15 symbol positions on the reels is displayed above the reels. Before the first free spin, each on the reels displays the prize from the corresponding location on the prize map. While a is held on the reels, the prize in the corresponding location on the prize map is also held. At the start of each free spin in GONG GONG LAI FU FEATURE, displayed prizes are redetermined for prize map squares that do not contain a held prize. Each new appearing in a free spin displays a prize value that it is the sum of all held prizes displayed on the prize map from the previous free spin within the same GONG GONG LAI FU FEATURE only. Each new appearing in a free spin resets the number of remaining free spins to 3 and is held in position for the duration of the GONG GONG LAI FU FEATURE. GONG GONG LAI FU FEATURE ends after all awarded free spins have been played or if appear in all 15 symbol positions. All prizes on Gong symbols are won at the end of feature.

**JACKPOT SURPRISE**



There is a chance that the GRAND JACKPOT is randomly won in bought games except when FREE GAMES FEATURE or GONG GONG LAI FU FEATURE is triggered.



**TYPE OF FEATURES**

Free Game + LP

**REEL CONFIGURATION**

5-Reel 3-Row Video Slot

**PAYLINES**

10, 25, 50 Lines (Denomination 1, 2)  
5, 10, 25 Lines (Denomination 3, 4, 5)  
5 Lines (Denomination 6, 7, 8)

**DENOMINATIONS**

SA							
1	2	3	4	5	6	7	8
R0.01	R0.02	R0.05	R0.10	R0.20	R1	R2	R5
R0.05	R0.10	R0.25	R0.50	R1	R5	R10	R25
R0.10	R0.20	R0.50	R1	R2	R10	R20	R50
R0.50	R1	R2.50	R5	R10	R50	R100	R250
R1	R2	R5	R10	R20	R100	R200	R500

EU							
1	2	3	4	5	6	7	8
€0.01	€0.02	€0.05	€0.10	€0.20	€1	€2	€5
€0.05	€0.10	€0.25	€0.50	€1	€5	€10	€25
€0.10	€0.20	€0.50	€1	€2	€10	€20	€50
€0.50	€1	€2.50	€5	€10	€50	€100	€250
€1	€2	€5	€10	€20	€100	€200	€500

**BET CONFIGURATIONS**

1, 2, 3, 4, 5  
1, 2, 3, 5, 8  
1, 2, 3, 5, 10  
1, 2, 5, 10, 20

**MAX BET**

250, 400, 500, 1000 (Denomination 1, 2)  
125, 200, 250, 500 (Denomination 3, 4, 5)  
25, 40, 50, 100 (Denomination 6, 7, 8)

# FU LAI CAI LAI 福来财来好运来 FORTUNE™

## 5 SEA LEGENDS™

## TRIPLE FESTIVAL™

## STACK WILD LUXURY™







Bold play opens the way to wild excitement and bigger wins. Increasing the bet level played improves several elements of gameplay, such as replacing a low paying symbol with a compounding triple-multiplier wild symbol on more and more reels, and unlocking a greater number of bonus and jackpot levels. Increasing credits bet per play makes a special payable available for the higher paying symbols. Free games can be retrigged during the free games. Multiple jackpot chance features can be triggered and even mystery bonuses and jackpots can be won suddenly.

BET LEVEL (if available)	BECOMES ON THE REELS ACCORDING TO BET LEVEL PLAYED	JACKPOT AND BONUS LEVELS BECOME AVAILABLE ACCORDING TO BET LEVEL PLAYED
Play 88 credits	5 ON REELS 2, 3, 4 AND 5 ONLY	GRAND JACKPOT - MAJOR JACKPOT - MINOR JACKPOT - WILD COIN BONUS - FREE GAMES
Play 66 credits	4 ON REELS 3, 4 AND 5 ONLY	MAJOR JACKPOT - MINOR JACKPOT - WILD COIN BONUS - FREE GAMES
Play 55 credits	3 ON REELS 4 AND 5 ONLY	MINOR JACKPOT - WILD COIN BONUS - FREE GAMES
Play 33 credits	2 ON REEL 5 ONLY	WILD COIN BONUS
Play 11 credits	NO REELS	NO JACKPOTS AVAILABLE

The JACKPOT FEATURE cannot be triggered and the WILD COIN BONUS cannot occur when playing bet level 1.

### FREE GAMES FEATURE



🎨 appearing on 3 or more consecutive reels beginning with the leftmost reel trigger the FREE GAMES FEATURE with 8 FREE GAMES.

During FREE GAMES FEATURE, reels contains Picture symbol only.

FREE GAMES FEATURE can be triggered again during the FREE GAMES FEATURE.

### TYPE OF FEATURES

Free Game + LP

### REEL CONFIGURATION

5-Reel 3-Row Video Slot

### PAYLINES

243 Ways

### DENOMINATIONS

#### SA

1	2	3	4	5	6	7
R0.01	R0.02	R0.05	R0.10	R0.20	R1	R2
R0.05	R0.10	R0.25	R0.50	R1	R5	R10
R0.10	R0.20	R0.50	R1	R2	R10	R20
R0.50	R1	R2.50	R5	R10	R50	R100
R1	R2	R5	R10	R20	R100	R200

#### EU

1	2	3	4	5	6	7
€0.01	€0.02	€0.05	€0.10	€0.20	€1	€2
€0.05	€0.10	€0.25	€0.50	€1	€5	€10
€0.10	€0.20	€0.50	€1	€2	€10	€20
€0.50	€1	€2.50	€5	€10	€50	€100
€1	€2	€5	€10	€20	€100	€200

### BET CONFIGURATIONS

1, 2, 3, 6, 10

### MAX BET

880

### JACKPOT FEATURE

There is a chance that 1 or more JACKPOT FEATURES are triggered when 1 or more 🎰 appear on the reels in a bought game or free game.



In the JACKPOT FEATURE, pick from 15 🎰 until 3 matching symbols corresponding to a PRIZE are revealed by picking 🎰 on the screen or by pressing the PLAY button which randomly picks a 🎰 with each press of the button. If 3 🎰 are revealed, an additional JACKPOT FEATURE is awarded and the feature continues until a PRIZE is won.

When 3 matching PRIZE have been revealed, the corresponding PRIZE is won and the JACKPOT FEATURE ends. Any additional JACKPOT FEATURE awarded, starts after the preceding JACKPOT FEATURE ends.

### WILD COIN BONUS



There is a chance the WILD COIN BONUS may occur when 1 or more 🎰 appear on the reels in a bought game or free game. When the WILD COIN BONUS occurs, one of the following PRIZES as displayed on the game screen is won.

PRIZE AMOUNT: equal to the total credits bet multiplied by either 10, 20, 30, 50 or 100 randomly as displayed.

BONUS: MINI BONUS or MINOR BONUS (available according to bet level played)

JACKPOT: MAJOR JACKPOT or GRAND JACKPOT (available according to bet level played)



Bold play opens the way to wild excitement and bigger wins. Increasing the bet level played improves several elements of gameplay, such as replacing a low paying symbol with stacks of wild symbols on more and more reels, and unlocking a greater number of bonus and jackpot levels. Increasing credits bet per play makes a special payable available for the higher paying symbols. During free games, one reel becomes wild each free spin. Multiple jackpot chance features can be triggered and even mystery bonuses and jackpots can be won suddenly.

BET LEVEL (if available)	BECOMES ON THE REELS ACCORDING TO BET LEVEL PLAYED	JACKPOT AND BONUS LEVELS BECOME AVAILABLE ACCORDING TO BET LEVEL PLAYED
Play 88 credits	ON REELS 2, 3, 4 AND 5 ONLY	MAJOR JACKPOT - GRAND JACKPOT - MINOR BONUS - MISTERY BONUS - MONEY BONUS
Play 66 credits	ON REELS 3, 4 AND 5 ONLY	MAJOR JACKPOT - GRAND JACKPOT - MONEY BONUS
Play 55 credits	ON REELS 4 AND 5 ONLY	MINOR BONUS - MISTERY BONUS
Play 33 credits	ON REEL 5 ONLY	MONEY BONUS
Play 11 credits	NO REELS	NO JACKPOTS AVAILABLE

The JACKPOT FEATURE cannot be triggered and the WILD COIN BONUS cannot occur when playing bet level 1.

### FREE GAMES FEATURE



☞ appearing on 3 or more consecutive reels beginning with the leftmost reel trigger the FREE GAMES FEATURE with 8 FREE GAMES.

In each free game, all symbols on 1 reel (within reels 2, 3, 4 or 5 according to bet level played) randomly becomes ☞.

FREE GAMES FEATURE cannot be triggered again during the FREE GAMES FEATURE.

### JACKPOT FEATURE

There is a chance that 1 or more JACKPOT FEATURES are triggered when 1 or more ☞ appear on the reels in a bought game or free game.



In the JACKPOT FEATURE, pick from 15 🍀 until 3 matching symbols corresponding to a PRIZE are revealed by picking 🍀 on the screen or by pressing the PLAY button which randomly picks a 🍀 with each press of the button. If 3 🍀 are revealed, an additional JACKPOT FEATURE is awarded and the feature continues until a PRIZE is won.

When 3 matching PRIZE have been revealed, the corresponding PRIZE is won and the JACKPOT FEATURE ends. Any additional JACKPOT FEATURE awarded, starts after the preceding JACKPOT FEATURE ends.

### WILD COIN BONUS



There is a chance the WILD COIN BONUS may occur when 1 or more ☞ appear on the reels in a bought game or free game. When the WILD COIN BONUS occurs, one of the following PRIZES as displayed on the game screen is won.

**PRIZE AMOUNT:** equal to the total credits bet multiplied by either 10, 20, 30, 50 or 100 randomly as displayed.

**BONUS:** MINI BONUS or MINOR BONUS (available according to bet level played)

**JACKPOT:** MAJOR JACKPOT or GRAND JACKPOT (available according to bet level played)



### TYPE OF FEATURES

Free Game + LP

### REEL CONFIGURATION

5-Reel 3-Row Video Slot

### PAYLINES

243 Ways

### DENOMINATIONS

SA						
1	2	3	4	5	6	7
R0.01	R0.02	R0.05	R0.10	R0.20	R1	R2
R0.05	R0.10	R0.25	R0.50	R1	R5	R10
R0.10	R0.20	R0.50	R1	R2	R10	R20
R0.50	R1	R2.50	R5	R10	R50	R100
R1	R2	R5	R10	R20	R100	R200

EU						
1	2	3	4	5	6	7
€0.01	€0.02	€0.05	€0.10	€0.20	€1	€2
€0.05	€0.10	€0.25	€0.50	€1	€5	€10
€0.10	€0.20	€0.50	€1	€2	€10	€20
€0.50	€1	€2.50	€5	€10	€50	€100
€1	€2	€5	€10	€20	€100	€200

### BET CONFIGURATIONS

1, 2, 3, 6, 10

### MAX BET

880

# GOD OF WINNING™

GREAT HAMMER

# GOD OF WINNING™

SUPER SPEAR







Divine lightning storms of wild wins strike with enriching power. Three types of scatters leave behind a golden frame after they appear. These golden frames are resilient and held until they all become wild in a bought game. Trigger the free games feature with these golden frames in place and repeatedly reap the rewards as all held frames become wild during the feature. The excitement doesn't stop there, as all held frames that are in place at the start of the free games feature are still held after the feature ends. More winning energy is also on tap when the four-level progressive wheel randomly spins up a jackpot.

### FREE GAMES FEATURE



There is a chance that FREE GAMES are triggered when 1 or more appear.  
 FREE GAMES consists of 7 free games.  
 Any held on the reels in the game that triggers the FREE GAMES become held for the duration of the FREE GAMES.  
 There is a chance in each free game that 1 or more symbol positions that do not contain held randomly become for one spin only.

After the FREE GAMES end, all held that became during FREE GAMES become held again.  
 FREE GAMES and JACKPOT WHEEL cannot be triggered in the same game.

### JACKPOT WHEEL



There is a chance that the JACKPOT WHEEL is triggered when 1 or more appear.  
 When the JACKPOT WHEEL is triggered, a wheel is displayed on the game screen and is spun once.  
 After the wheel is spun, 1 wheel segment indicated by the pointer at the top of the wheel is selected.

The wheel contains the following:

**JACKPOTS:** GRAND, MAJOR, MINOR and MINI

Pressing the PLAY button or touching the game screen spins the wheel. JACKPOT WHEEL and FREE GAMES cannot be triggered in the same game. After a jackpot is won, the JACKPOT WHEEL ends.

### WILD ZONE and WILD BONUS



There is a chance that WILD ZONE occurs for 3, 4 or 5 bought games, randomly. When WILD ZONE occurs, the reel frame takes on the following appearance for the duration of the WILD ZONE: .  
 There is a chance that WILD CHANGE occurs in the WILD ZONE one time only. If WILD CHANGE occurs in the WILD ZONE, the WILD BONUS is triggered for up to 5 bought games, randomly.  
 During each WILD BONUS game, appear on 8 or more random symbol positions that become on stopped reels for 1 spin only.  
 If WILD BONUS is triggered, the WILD ZONE is extended until the WILD BONUS ends. All wins determined on stopped reels after the completion of symbol changes. After all wins are determined in each game of the WILD BONUS, any are removed.



### TYPE OF FEATURES

Free Game + LP

### REEL CONFIGURATION

5-Reel 4-Row Video Slot

### PAYLINES

25 Lines

### DENOMINATIONS

**SA** R0.10

**EU** €0.01

### BET CONFIGURATIONS

1, 2, 3, 4, 5, 6, 8, 10

### MIN/MAX BET

75 Bet up to 750 Bet

(Depends on the above Bet Configurations)



Divine lightning storms of wild wins strike with enriching power. Three types of scatters leave behind a golden frame after they appear. These golden frames are resilient and held until they all become wild in a bought game. Trigger the free games feature with these golden frames in place and repeatedly reap the rewards as all held frames become wild during the feature. The excitement doesn't stop there, as all held frames that are in place at the start of the free games feature are still held after the feature ends. More winning energy is also on tap when the four-level progressive wheel randomly spins up a jackpot.

### FREE GAMES FEATURE



There is a chance that FREE GAMES are triggered when 1 or more appear.

FREE GAMES consists of 7 free games.

Any held on the reels in the game that triggers the FREE GAMES become held for the duration of the FREE GAMES.

There is a chance in each free game that 1 or more symbol positions that do not contain held randomly become for one spin only.

After the FREE GAMES end, all held that became during FREE GAMES become held again. FREE GAMES and JACKPOT WHEEL cannot be triggered in the same game.

### JACKPOT WHEEL



There is a chance that the JACKPOT WHEEL is triggered when 1 or more appear.

When the JACKPOT WHEEL is triggered, a wheel is displayed on the game screen and is spun once.

After the wheel is spun, 1 wheel segment indicated by the pointer at the top of the wheel is selected.

The wheel contains the following:

JACKPOTS: GRAND, MAJOR, MINOR and MINI

Pressing the PLAY button or touching the game screen spins the wheel. JACKPOT WHEEL and FREE GAMES cannot be triggered in the same game. After a jackpot is won, the JACKPOT WHEEL ends.

### WILD ZONE AND WILD BONUS



There is a chance that WILD ZONE occurs for 3, 4 or 5 bought games, randomly. When WILD ZONE occurs, the reel frame takes on the following appearance for the duration of the WILD ZONE: .

There is a chance that WILD CHANGE occurs in the WILD ZONE one time only. If WILD CHANGE occurs in the WILD ZONE, the WILD BONUS is triggered for up to 5 bought games, randomly.

During each WILD BONUS game, appear on 8 or more random symbol positions that become on stopped reels for 1 spin only.

If WILD BONUS is triggered, the WILD ZONE is extended until the WILD BONUS ends. All wins determined on stopped reels after the completion of symbol changes. After all wins are determined in each game of the WILD BONUS, any are removed.

### TYPE OF FEATURES

Free Game + LP

### REEL CONFIGURATION

5-Reel 4-Row Video Slot

### PAYLINES

25 Lines

### DENOMINATIONS

SA R0.10

EU €0.01

### BET CONFIGURATIONS

1, 2, 3, 4, 5, 6, 8, 10

### MIN/MAX BET

75 Bet up to 750 Bet

(Depends on the above Bet Configurations)

# TRIPLE TREASURE POT™





Win big with an abundance of multiple features played at the same time. The three pots on screen represent bonus feature elements that can occur individually or combined in a single feature. Bonus feature elements consist of special credit prize symbols that nudge to fill their reels, special prize symbols awarding instant credit prizes and bonus/jackpot coins that are collected for big payouts, and expanding reels increasing the number of wins. There are also three randomly triggered prize actions that either instantly pay all displayed prizes on special symbols as shown, add on to prize values before there are paid, or multiplies prize values before they are paid.

**TYPE OF FEATURES**

Free Game + LP

**REEL CONFIGURATION**

5-Reel 4-Row Video Slot  
5-Reel 6-Row (During the Ox Feature only)

**PAYLINES**

50 Lines  
100 Lines (During the Ox Feature only)

**DENOMINATIONS**

SA		
1	2	3
R0.01	R0.02	R0.05
R0.10	R0.20	R0.50
R1	R2	R5

EU		
1	2	3
€0.01	€0.02	€0.05
€0.10	€0.20	€0.50
€1	€2	€5

**BET CONFIGURATIONS**

1, 2, 3, 6, 10

**MAX BET**

880

**TIGER FEATURE**



There is a chance that the TIGER FEATURE is triggered when 1 or more appear. TIGER FEATURE awards 5 free spins. Different reels are used during the TIGER FEATURE. Any reel with 1, 2 or 3 nudges to show 4 when any ACTION SYMBOL appears on reel 5. Line wins are determined only once before any reel nudge occurs. Prizes on are won only once after any reel nudge occurs. Any other FEATURE triggered during the TIGER FEATURE starts after the TIGER FEATURE ends, except ACTION PRIZES FEATURE.

**DRAGON FEATURE**



There is a chance that the DRAGON FEATURE is triggered when 1 or more appear. DRAGON FEATURE awards 10 free spins. Different reels are used during the DRAGON FEATURE. 1 of the following is displayed on each .

- CREDIT PRIZE: 100, 500 or 1000 credits multiplied by bet multiplier as displayed.
- MINI, MINOR, MAJOR or GRAND

Each CREDIT PRIZE displayed on is won. Each MINI, MINOR, MAJOR or GRAND displayed on is collected in its corresponding meter on the screen. Each appearing awards 1 additional free spin.

**OX FEATURE**



There is a chance that the OX FEATURE is triggered when 1 or more appear. OX FEATURE awards 5 free spins. Different reels are used during the OX FEATURE. Before the OX FEATURE starts, all reels are expanded upward 2 rows of symbols. Any other FEATURE triggered during the OX FEATURE starts after the OX FEATURE ends, except ACTION PRIZES FEATURE.

**ACTION PRIZES FEATURE**



Any combination of 1 or more and 1 ACTION SYMBOL trigger the corresponding ACTION PRIZE shown below.

ACTION SYMBOL	ACTION PRIZE
	Each prize displayed  is won.
	Each prize displayed on  is won after being increased by the credit value displayed on .
	Each displayed on  is won after being multiplied by the multiplier displayed on .



Win big with an abundance of multiple features played at the same time. The three pots on screen represent bonus feature elements that can occur individually or combined in a single feature. Bonus feature elements consist of special credit prize symbols that nudge to fill their reels, special prize symbols awarding instant credit prizes and bonus/jackpot coins that are collected for big payouts, and expanding reels increasing the number of wins. There are also three randomly triggered prize actions that either instantly pay all displayed prizes on special symbols as shown, add on to prize values before there are paid, or multiplies prize values before they are paid.

### TIGER FEATURE



There is a chance that the TIGER FEATURE is triggered when 1 or more appear. TIGER FEATURE awards 5 free spins. Any reel with 1, 2 or 3 nudges to show 4 when any ACTION SYMBOL appears on reel 5. Line wins are determined only once before any reel nudge occurs. Prizes on are won only once after any reel nudge occurs. Any other FEATURE triggered during the TIGER FEATURE starts after the TIGER FEATURE ends, except ACTION PRIZES FEATURE.

### DRAGON FEATURE



There is a chance that the DRAGON FEATURE is triggered when 1 or more appear. DRAGON FEATURE awards 10 free spins. Each CREDIT PRIZE displayed on is won. Each MINI, MINOR, MAJOR or GRAND displayed on is collected in its corresponding meter on the screen. Each appearing awards 1 additional free spin.

### OX FEATURE



There is a chance that the OX FEATURE is triggered when 1 or more appear. OX FEATURE awards 5 free spins. Before the OX FEATURE starts, all reels are expanded upward 2 rows of symbols. Any other FEATURE triggered during the OX FEATURE starts after the OX FEATURE ends, except ACTION PRIZES FEATURE.

### ACTION PRIZES FEATURE



Any combination of 1 or more and 1 ACTION SYMBOL trigger the corresponding ACTION PRIZE shown below.

ACTION SYMBOL	ACTION PRIZE
	Each prize displayed  is won.
	Each prize displayed on  is won after being increased by the credit value displayed on .
	Each displayed on  is won after being multiplied by the multiplier displayed on .



### TYPE OF FEATURES

Free Game + LP

### REEL CONFIGURATION

5-Reel 4-Row Video Slot

5-Reel 6-Row (During the Ox Feature only)

### PAYLINES

50 Lines

100 Lines (During the Ox Feature only)

### DENOMINATIONS

#### SA

1	2	3
R0.01	R0.02	R0.05
R0.10	R0.20	R0.50
R1	R2	R5

#### EU

1	2	3
€0.01	€0.02	€0.05
€0.10	€0.20	€0.50
€1	€2	€5

### BET CONFIGURATIONS

1, 2, 3, 6, 10

### MAX BET

880

# LONGFUZHU™





Mighty dragon breathe fire to unlock superb win. Jackpot Feature randomly triggered in bought games. All prizes displayed on the orb symbols are held in the position for the duration of the DRAGON ORB FEATURE are won including bonus and jackpots. Reels used during the FREE GAMES FEATURE contain a greater total number of

### FREE GAMES FEATURE



Any 3 appearing on reels 2, 3 and 4 trigger the FREE GAMES FEATURE with 6 free games. Reels used during the FREE GAMES FEATURE contain a greater total number of .

FREE GAMES FEATURE can be triggered again during the FREE GAMES FEATURE. FREE GAMES FEATURE starts after the DRAGON ORB FEATURE ends if triggered in the same game. If triggered in the same game, the FREE GAMES FEATURE starts after the DRAGON ORB FEATURE ends.

### DRAGON ORB FEATURE



Any 6 or more appearing in a bought game or free game trigger the DRAGON ORB FEATURE. When DRAGON ORB FEATURE is triggered, 3 free spins are awarded. During the DRAGON ORB FEATURE, each symbol position becomes an individual spinning bonus reel.

Before the DRAGON ORB FEATURE starts, all reels are expanded upward 1 row of symbols and reel 5 is locked. At the start of DRAGON ORB FEATURE, only 6 appear on random symbol positions on reels 1, 2, 3 and 4 and are held in the position for the duration of the DRAGON ORB FEATURE. In each free spin, reel 5 is locked if no new appearing on the reels. Any newly appearing in a free spin unlocks the reel 5, resets the number of remaining free spins to 3 and is held in position until the DRAGON ORB FEATURE ends.

PRIZES	ACTION PRIZE
<b>MULTIPLIER</b> x2, x3 or x5	Each prize displayed on held  appearing on one row is being multiplied by the multiplier displayed on its reel 5.
<b>PRIZE AMOUNT</b> each equal to 30, 40, 60, 80, 100, 150, 200 or 250 credits multiplied by bet multiplier as displayed	Each prize displayed on held  appearing on one row is being increased by the amount value displayed on its reel 5.
<b>BONUS</b> MINI BONUS, MINOR BONUS or MAJOR BONUS	Each prize displayed on held  appearing on one row is being increased by the bonus value displayed on its reel 5.
<b>JACKPOT</b> MAJOR JACKPOT	Each prize displayed on held  appearing on one row is being increased by the jackpot value displayed on its reel 5.

When the reel 5 unlocks, it will spin automatically and each symbol position displayed one of the available prizes.

DRAGON ORB FEATURE ends after all awarded free spins have been played or if appear in all 16 symbol positions on reels 1, 2, 3 and 4.



### MYSTERY JACKPOT AWARD

There is a chance that the GRAND JACKPOT is randomly won in bought games except when FREE GAMES FEATURE or DRAGON ORB FEATURE is triggered.



### TYPE OF FEATURES

Free Game + LP

### REEL CONFIGURATION

5-Reel 3-Row Video Slot

### PAYLINES

50 Lines (Denomination 1, 2)

25 Lines (Denomination 3, 4, 5)

5 Lines (Denomination 6, 7, 8)

### DENOMINATIONS

#### SA

1	2	3	4	5	6	7	8
R0.01	R0.02	R0.05	R0.10	R0.20	R1	R2	R5
R0.05	R0.10	R0.25	R0.50	R1	R5	R10	R25
R0.10	R0.20	R0.50	R1	R2	R10	R20	R50
R0.50	R1	R2.50	R5	R10	R50	R100	R250
R1	R2	R5	R10	R20	R100	R200	R500

#### EU

1	2	3	4	5	6	7	8
€0.01	€0.02	€0.05	€0.10	€0.20	€1	€2	€5
€0.05	€0.10	€0.25	€0.50	€1	€5	€10	€25
€0.10	€0.20	€0.50	€1	€2	€10	€20	€50
€0.50	€1	€2.50	€5	€10	€50	€100	€250
€1	€2	€5	€10	€20	€100	€200	€500

### BET CONFIGURATIONS

1, 2, 3, 4, 5

1, 2, 3, 5, 8

1, 2, 3, 5, 10

1, 2, 5, 10, 20

### MAX BET

400, 640, 800, 1600 (Denomination 1, 2)

200, 320, 400, 800 (Denomination 3, 4, 5)

40, 64, 80, 160 (Denomination 6, 7, 8)



Mighty dragon breathe fire to unlock superb win. Jackpot Feature randomly triggered in bought games. All prizes displayed on the orb symbols are held in the position for the duration of the DRAGON ORB FEATURE are won including bonus and jackpots. During the FREE GAMES FEATURE, substituting in a win becomes .

### FREE GAMES FEATURE



Any 3 appearing on reels 2, 3 and 4 trigger the FREE GAMES FEATURE with 6 free games. During the FREE GAMES FEATURE, substituting in a win becomes . The sum of multipliers from every that substitutes in a win multiplies the pay for that win. FREE GAMES FEATURE can be triggered again during the FREE GAMES FEATURE. FREE GAMES FEATURE starts after the DRAGON ORB FEATURE ends if triggered in the same game. If triggered in the same game, the FREE GAMES FEATURE starts after the DRAGON ORB FEATURE ends.

### DRAGON ORB FEATURE



Any 6 or more appearing in a bought game or free game trigger the DRAGON ORB FEATURE. When DRAGON ORB FEATURE is triggered, 3 free spins are awarded. During the DRAGON ORB FEATURE, each symbol position becomes an individual spinning bonus reel.

Before the DRAGON ORB FEATURE starts, all reels are expanded upward 1 row of symbols and reel 5 is locked. At the start of DRAGON ORB FEATURE, only 6 appear on random symbol positions on reels 1, 2, 3 and 4 and are held in the position for the duration of the DRAGON ORB FEATURE. In each free spin, reel 5 is locked if no new appearing on the reels. Any newly appearing in a free spin unlocks the reel 5, resets the number of remaining free spins to 3 and is held in position until the DRAGON ORB FEATURE ends.

PRIZES	ACTION PRIZE
<b>MULTIPLIER</b> x2, x3 or x5	Each prize displayed on held  appearing on one row is being multiplied by the multiplier displayed on its reel 5.
<b>PRIZE AMOUNT</b> each equal to 30, 40, 50, 80, 100, 150, 200 or 250 credits multiplied by bet multiplier as displayed	Each prize displayed on held  appearing on one row is being increased by the amount value displayed on its reel 5.
<b>BONUS</b> MINOR BONUS or MAJOR BONUS	Each prize displayed on held  appearing on one row is being increased by the bonus value displayed on its reel 5.
<b>JACKPOT</b> MAJOR JACKPOT	Each prize displayed on held  appearing on one row is being increased by the jackpot value displayed on its reel 5.

When the reel 5 unlocks, it will spin automatically and each symbol position displayed one of the available prizes. DRAGON ORB FEATURE ends after all awarded free spins have been played or if appear in all 16 symbol positions on reels 1, 2, 3 and 4.

### TYPE OF FEATURES

Free Game + LP

### REEL CONFIGURATION

5-Reel 3-Row Video Slot

### PAYLINES

50 Lines (Denomination 1, 2)  
25 Lines (Denomination 3, 4, 5)  
5 Lines (Denomination 6, 7, 8)

### DENOMINATIONS

#### SA

1	2	3	4	5	6	7	8
R0.01	R0.02	R0.05	R0.10	R0.20	R1	R2	R5
R0.05	R0.10	R0.25	R0.50	R1	R5	R10	R25
R0.10	R0.20	R0.50	R1	R2	R10	R20	R50
R0.50	R1	R2.50	R5	R10	R50	R100	R250
R1	R2	R5	R10	R20	R100	R200	R500

#### EU

1	2	3	4	5	6	7	8
€0.01	€0.02	€0.05	€0.10	€0.20	€1	€2	€5
€0.05	€0.10	€0.25	€0.50	€1	€5	€10	€25
€0.10	€0.20	€0.50	€1	€2	€10	€20	€50
€0.50	€1	€2.50	€5	€10	€50	€100	€250
€1	€2	€5	€10	€20	€100	€200	€500

### BET CONFIGURATIONS

1, 2, 3, 4, 5  
1, 2, 3, 5, 8  
1, 2, 3, 5, 10  
1, 2, 5, 10, 20

### MAX BET

400, 640, 800, 1600 (Denomination 1, 2)  
200, 320, 400, 800 (Denomination 3, 4, 5)  
40, 64, 80, 160 (Denomination 6, 7, 8)



### MYSTERY JACKPOT AWARD

There is a chance that the GRAND JACKPOT is randomly won in bought games except when FREE GAMES FEATURE or DRAGON ORB FEATURE is triggered.





**MUSO™**  
TRIPLE-32HB

mu·so [ mōō - sō ] adj.  
being the only one of its kind;  
unlike anything else.

A stunning new honeycomb cabinet LED display to attract players.  
Thoughtful touches to keep them comfortable.  
All designed for an unparalleled gaming experience.



**Stunning HD Graphics**

Breathtakingly clear and bursting with rich colors displayed on three large 32-inch LCD monitor.

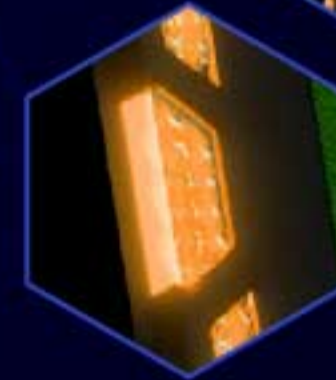

**New honeycomb LED**

Creating a unique visual experience not replicated in the market.



**Ergonomic Button Deck**

Inviting wrist rest and expansive glass table. Completely new interface design displayed on a 13.3-inch LCD deck.



**New Face Design**

Equipped with Qi standard wireless charger. USB charging port also provided for player convenience.

**DIMENSION**

**Upright Height (Tower Light Included)**

93.1 in (2365 mm)

**Upright Height (Tower Light Excluded)**

89.4 in (2271 mm)

**Width**

31.9 in (810 mm)

**Depth**

27 in (685.4 mm)

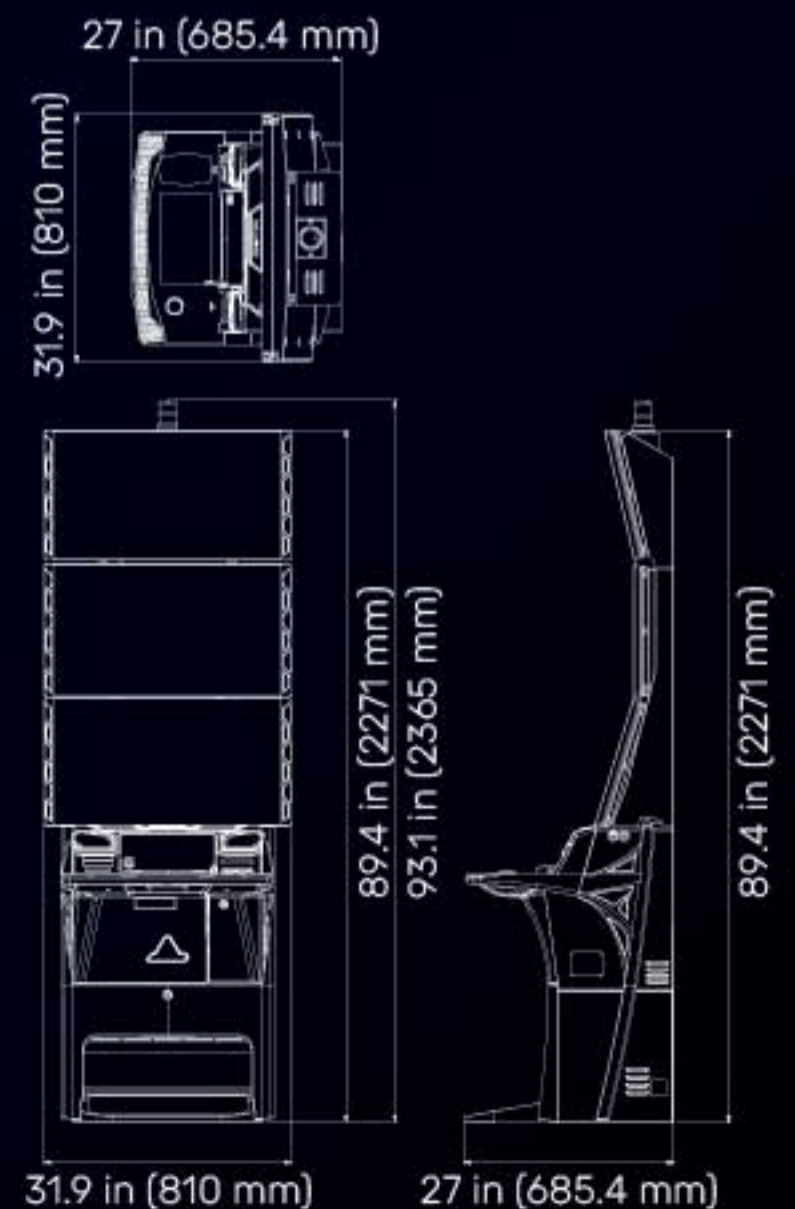

**BUILT FOR EXCELLENCE**

# BOMB

## COLLECTOR™ GOLD HEIST

# BOMB

## COLLECTOR™ TREASURE HEIST

**BOMB**  
COLLECTOR  
GOLD HEIST

**GRAND**  
\$5,000.00

**MAJOR**  
\$500.00

**MINOR**  
\$25.00

**MINI**  
\$10.00

**▲ HOLD BOMB SPIN ▲**  
3 STACKED **○** TRIGGER THE HOLD BOMB SPIN WITH 3 TYPES OF FEATURES AVAILABLE.

3 STACKED **○** TRIGGER THE HOLD BOMB SPIN.

10	Q	WILD	SKULL	10
10	Q	J	SKULL	10
A	Q	K	SKULL	9

1c CREDITS 2000 BET 375 WIN 0

**BOMB**  
COLLECTOR  
TREASURE HEIST

**GRAND**  
\$5,000.00

**MAJOR**  
\$500.01

**MINOR**  
\$25.02

**MINI**  
\$10.03

**▲ HOLD BOMB SPIN ▲**  
3 STACKED **○** TRIGGER THE HOLD BOMB SPIN WITH 3 TYPES OF FEATURES AVAILABLE.

3 STACKED **○** TRIGGER THE HOLD BOMB SPIN.

10	Q	WILD	SKULL	10
10	Q	J	SKULL	10
A	Q	K	SKULL	9

1c CREDITS 2000 BET 375 WIN 0





Bomb explosions full of surprises. When bombs explode, they can trigger one of the explosive features: WILD BOOM, PRIZE BLAST, FREE GAMES EXPLOSION and JACKPOT FEATURE. More Jackpots can be also won when wild appears: GRAND, MAJOR, MINOR, MINI.

### HOLD BOMB SPIN



HOLD BOMB SPIN are held in position until the completion of the last HOLD BOMB SPIN. Each symbol position becomes an individual spinning bonus reel during HOLD BOMB SPIN. 1 additional free HOLD BOMB SPIN is awarded if any 1 or more new appear in any HOLD BOMB SPIN. If appears in all 15 symbol positions, no additional HOLD BOMB SPIN is awarded and the reels do not spin. HOLD BOMB SPIN starts after the JACKPOT FEATURE ends if triggered in the same bought game. After the last HOLD BOMB SPIN only, all held on the reels explode to award 1 of the following symbol change features: WILD BOOM, PRIZE BLAST or FREE GAMES EXPLOSION.

### WILD BOOM



1 free HOLD BOMB SPIN is triggered if 3 stacked appear on at least any one reel in bought games only. Any appearing in the bought game that triggers the HOLD BOMB SPIN or appearing in any additionally awarded free HOLD BOMB SPIN are held in position until the completion of the last HOLD BOMB SPIN. Each symbol position becomes an individual spinning bonus reel during HOLD BOMB SPIN. 1 additional free HOLD BOMB SPIN is awarded if any 1 or more new appear in any HOLD BOMB SPIN. If appears in all 15 symbol positions, no additional HOLD BOMB SPIN is awarded and the reels do not spin. HOLD BOMB SPIN starts after the JACKPOT FEATURE ends if triggered in the same bought game. After the last HOLD BOMB SPIN only, all held on the reels explode to award 1 of the following symbol change features: WILD BOOM, PRIZE BLAST or FREE GAMES EXPLOSION.

If WILD BOOM is awarded, each held explodes to become awarding 1 of the following prizes: PRIZE AMOUNT: 20, 30, 40, 50, 60, 75, 100, 125, 150, 200, 250, 300, 400, 500, 750, 1000, 1500, 2000, 2500 or 3000 credits multiplied by bet multiplier as displayed.

### PRIZE BLAST



If PRIZE BLAST is awarded, each held explodes to become awarding 1 of the following prizes: PRIZE AMOUNT: 20, 30, 40, 50, 60, 75, 100, 125, 150, 200, 250, 300, 400, 500, 750, 1000, 1500, 2000, 2500 or 3000 credits multiplied by bet multiplier as displayed.

JACKPOT: MINI, MINOR, MAJOR or GRAND (only 1 may display a JACKPOT).

If PRIZE BLAST is awarded, line wins are not determined again and therefore any line wins are not paid again.

### FREE GAMES EXPLOSION



If FREE GAMES EXPLOSION is awarded, each held explodes to become awarding 1 of the following: 1, 2, 3, 4 or 5 free games. The sum of free games displayed on are awarded.

If FREE GAMES EXPLOSION is awarded, line wins are not determined again and therefore any line wins are not paid again.

Each free game, any appearing explodes to become awarding 1 of the following:

PRIZE AMOUNT: 20, 30, 40, 50, 75, 100, 125, 150, 200, 250, 300, 400, 500 or 750 credits multiplied by bet multiplier as displayed.

+1 SPIN: awards 1 additional free game.

Each free game, any appearing explodes to become awarding 1 of the following:

PRIZE AMOUNT: 100, 125, 150, 200, 250, 300, 400, 500, 750 or 1000 credits multiplied by bet multiplier as displayed.

+1 SPIN: awards 1 additional free game.

Each free game, any appearing explodes to become awarding 1 of the following:

PRIZE AMOUNT: 250, 300, 400, 500, 750, 1000, 1500, 2000, 2500 or 3000 credits multiplied by bet multiplier as displayed.

+1 SPIN: awards 1 additional free game Credits bet and lines played during the free games are the same as the game that triggered the free games.

### JACKPOT FEATURE



There is a chance that the JACKPOT FEATURE may be triggered when 1 or more appear in bought games only. In the JACKPOT FEATURE, select from 12 icons until 3 matching symbols corresponding to a JACKPOT level are revealed.

When 3 matching JACKPOT level symbols have been revealed, the corresponding JACKPOT level is won and the JACKPOT FEATURE ends.



### TYPE OF FEATURES

Free Game + LP

### REEL CONFIGURATION

5-Reel 3-Row Video Slot

### PAYLINES

30 Lines

### DENOMINATIONS

SA R0.10

EU €0.01

### BET CONFIGURATIONS

1, 2, 3, 4, 5, 6, 7, 8, 9, 10

### MIN/MAX BET

75 Bet up to 750 Bet

(Depends on the above Bet Configurations)



This bomb packs with full of surprises when explodes. When bomb explode it may awards one of the following prizes: WILD BOOM, PRIZE BLAST, FREE GAMES EXPLOSION and JACKPOT FEATURE. When wild appears it may also awards 1 of the Jackpots: GRAND, MAJOR, MINOR, MINI.

**TYPE OF FEATURES**

Free Game + LP

**REEL CONFIGURATION**

5-Reel 3-Row Video Slot

**PAYLINES**

30 Lines

**DENOMINATIONS**

SA R0.10

EU €0.01

**BET CONFIGURATIONS**

1, 2, 3, 4, 5, 6, 7, 8, 9, 10

**MIN/MAX BET**

75 Bet up to 750 Bet

(Depends on the above Bet Configurations)

**HOLD BOMB SPIN**



HOLD BOMB SPIN are held in position until the completion of the last HOLD BOMB SPIN. Each symbol position becomes an individual spinning bonus reel during HOLD BOMB SPIN. 1 additional free HOLD BOMB SPIN is awarded if any 1 or more new bomb appear in any HOLD BOMB SPIN. If bomb appears in all 15 symbol positions, no additional HOLD BOMB SPIN is awarded and the reels do not spin. HOLD BOMB SPIN starts after the JACKPOT FEATURE ends if triggered in the same bought game. After the last HOLD BOMB SPIN only, all held bomb on the reels explode to award 1 of the following symbol change features: WILD BOOM, PRIZE BLAST or FREE GAMES EXPLOSION.

1 free HOLD BOMB SPIN is triggered if 3 stacked bomb appear on at least any one reel in bought games only. Any bomb appearing in the bought game that triggers the HOLD BOMB SPIN or appearing in any additionally awarded free

**WILD BOOM**



If WILD BOOM is awarded, each held bomb explodes to become wild, wild or wild. If WILD BOOM is awarded, line wins are determined again and any resulting line wins are paid. The sum of the multipliers from every wild / wild that substitutes in a win multiplies the pay for that win.

If WILD BOOM is awarded, each held bomb explodes to become wild, wild or wild. If WILD BOOM is awarded, line wins are determined again and any resulting line wins are paid. The sum of the multipliers from every wild / wild that substitutes in a win multiplies the pay for that win.

**PRIZE BLAST**



If PRIZE BLAST is awarded, each held bomb explodes to become awarding 1 of the following prizes: PRIZE AMOUNT: 20, 30, 40, 50, 60, 75, 100, 125, 150, 200, 250, 300, 400, 500, 750, 1000, 1500, 2000, 2500 or 3000 credits multiplied by bet multiplier as displayed.

If PRIZE BLAST is awarded, each held bomb explodes to become awarding 1 of the following prizes: PRIZE AMOUNT: 20, 30, 40, 50, 60, 75, 100, 125, 150, 200, 250, 300, 400, 500, 750, 1000, 1500, 2000, 2500 or 3000 credits multiplied by bet multiplier as displayed.

JACKPOT: MINI, MINOR, MAJOR or GRAND (only 1 bomb may display a JACKPOT).

If PRIZE BLAST is awarded, line wins are not determined again and therefore any line wins are not paid again.

**FREE GAMES EXPLOSION**



If FREE GAMES EXPLOSION is awarded, line wins are not determined again and therefore any line wins are not paid again.

If FREE GAMES EXPLOSION is awarded, each held bomb explodes to become awarding 1 of the following: 1, 2, 3, 4 or 5 free games. The sum of free games displayed on are awarded.

Each free game, any appearing bomb explodes to become awarding 1 of the following:

PRIZE AMOUNT: 20, 30, 40, 50, 75, 100, 125, 150, 200, 250, 300, 400, 500 or 750 credits multiplied by bet multiplier as displayed.

+1 SPIN: awards 1 additional free game.

Each free game, any appearing bomb explodes to become awarding 1 of the following:

PRIZE AMOUNT: 100, 125, 150, 200, 250, 300, 400, 500, 750 or 1000 credits multiplied by bet multiplier as displayed.

+1 SPIN: awards 1 additional free game.

Each free game, any appearing bomb explodes to become awarding 1 of the following:

PRIZE AMOUNT: 250, 300, 400, 500, 750, 1000, 1500, 2000, 2500 or 3000 credits multiplied by bet multiplier as displayed.

+1 SPIN: awards 1 additional free game Credits bet and lines played during the free games are the same as the game that triggered the free games.

**JACKPOT FEATURE**



When 3 matching JACKPOT level symbols have been revealed, the corresponding JACKPOT level is won and the JACKPOT FEATURE ends.

There is a chance that the JACKPOT FEATURE may be triggered when 1 or more wild appear in bought games only. In the JACKPOT FEATURE, select from 12 icons until 3 matching symbols corresponding to a JACKPOT level are revealed.

# DIAMOND PAYS™

## ORIENTAL PRINCESS

# DIAMOND PAYS™

## ARABIAN OASIS





Successive chains of prize collecting features award dazzling treasure. Especially-persistent bonus symbols trigger free spins in which there is a greater chance to trigger a prize collection feature. After completing any prize collection feature, the especially-persistent bonus symbols trigger more free spins in which there is a greater chance to trigger the prize collection feature again. All credit prizes and jackpots on the held bonus symbols at the end of the prize collection feature are won. Additionally, mystery bonuses and jackpots can be won in bought games.

**CHANCE SPIN FEATURE**



Any 1 or more appearing in a bought game trigger the CHANCE SPIN FEATURE.  
 Any / appearing in the bought game that trigger the CHANCE SPIN FEATURE are held in position until the CHANCE SPIN FEATURE or WIN COLLECTOR ends.  
 When the CHANCE SPIN FEATURE is triggered, 3 free spins are awarded.  
 Each newly appearing / in a free spin resets the number of remaining free spins to 3 and is held in position until the CHANCE SPIN FEATURE or the WIN COLLECTOR ends.  
 When the WIN COLLECTOR ends, any 1 or more held on the reels trigger the CHANCE SPIN FEATURE again and are held in position until the CHANCE SPIN FEATURE or WIN COLLECTOR ends.  
 Any held on the reels are removed before the retriggered CHANCE SPIN FEATURE starts.

**WIN COLLECTOR**



Any combination of 6 or more / appearing in a bought game or the CHANCE SPIN FEATURE trigger the WIN COLLECTOR and are held in position for the duration of the WIN COLLECTOR.  
 When the WIN COLLECTOR is triggered, 3 free spins are awarded.  
 Each newly appearing in a free spin resets the number of remaining free spins to 3 and is held in position until the WIN COLLECTOR ends. WIN COLLECTOR ends after all awarded free spins have been played or if / appear in all 15 symbol positions.

**JACKPOTS AND BONUSES**



There is a chance that 1 of the following prizes is randomly won in bought games except when the CHANCE SPIN FEATURE or WIN COLLECTOR is triggered.

- GRAND JACKPOT
- MAJOR JACKPOT

**TYPE OF FEATURES**

Free Game + LP

**REEL CONFIGURATION**

5-Reel 3-Row Video Slot

**PAYLINES**

10, 20, 25, 30, 50 Lines (Denomination 1, 2, 3, 4)

1, 5, 10, 15, 25 Lines (Denomination 4)

1, 2, 3, 4, 5 Lines (Denomination 4, 5, 6)

**DENOMINATIONS**

SA					
1	2	3	4	5	6
R0.01	R0.02	R0.05	R0.10	R1	R2
R0.05	R0.10	R0.25	R0.50	R5	R10
R0.10	R0.20	R0.50	R1	R10	R20
R0.50	R1	R2.50	R5	R50	R100
R1	R2	R5	R10	R100	R200

EU					
1	2	3	4	5	6
€0.01	€0.02	€0.05	€0.10	€1	€2
€0.05	€0.10	€0.25	€0.50	€5	€10
€0.10	€0.20	€0.50	€1	€10	€20
€0.50	€1	€2.50	€5	€50	€100
€1	€2	€5	€10	€100	€200

**BET CONFIGURATIONS**

1, 2, 3, 4, 5

1, 2, 3, 5, 8

1, 2, 3, 5, 10

**MAX BET**

250, 400, 500 (Denomination 1, 2, 3, 4)

125, 200, 250 (Denomination 4)

25, 40, 50 (Denomination 4, 5, 6)



Successive chains of prize collecting features award dazzling treasure. Especially-persistent bonus symbols trigger free spins in which there is a greater chance to trigger a prize collection feature. After completing any prize collection feature, the especially-persistent bonus symbols trigger more free spins in which there is a greater chance to trigger the prize collection feature again. All credit prizes and jackpots on the held bonus symbols at the end of the prize collection feature are won. Additionally, mystery bonuses and jackpots can be won in bought games.

**CHANCE SPIN FEATURE**



Any 1 or more appearing in a bought game trigger the CHANCE SPIN FEATURE. Any / appearing in the bought game that trigger the CHANCE SPIN FEATURE are held in position until the CHANCE SPIN FEATURE or COLLECT FEATURE ends. When the CHANCE SPIN FEATURE is triggered, 3 free spins are awarded. Each newly appearing / in a free spin resets the number of remaining free spins to 3 and is held in position until the CHANCE SPIN FEATURE or COLLECT FEATURE ends. When the COLLECT FEATURE ends, any 1 or more held on the reels trigger the CHANCE SPIN FEATURE again and are held in position until the CHANCE SPIN FEATURE or COLLECT FEATURE ends. Any held on the reels are removed before the retriggered CHANCE SPIN FEATURE starts.

**COLLECT FEATURE**



Any combination of 6 or more / appearing in a bought game or the CHANCE SPIN FEATURE trigger the COLLECT FEATURE and are held in position for the duration of the COLLECT FEATURE. When the COLLECT FEATURE is triggered, 3 free spins are awarded. Each newly appearing in a free spin resets the number of remaining free spins to 3 and is held in position until the COLLECT FEATURE ends. COLLECT FEATURE ends after all awarded free spins have been played or if / appear in all 15 symbol positions.

**JACKPOTS AND BONUSES**



There is a chance that 1 of the following prizes is randomly won in bought games except when the CHANCE SPIN FEATURE or COLLECT FEATURE is triggered.

- GRAND JACKPOT
- MAJOR JACKPOT



**TYPE OF FEATURES**

Free Game + LP

**REEL CONFIGURATION**

5-Reel 3-Row Video Slot

**PAYLINES**

10, 20, 25, 30, 50 Lines (Denomination 1, 2, 3, 4)  
1, 5, 10, 15, 25 Lines (Denomination 4)  
1, 2, 3, 4, 5 Lines (Denomination 4, 5, 6)

**DENOMINATIONS**

SA						
1	2	3	4	5	6	
R0.01	R0.02	R0.05	R0.10	R1	R2	
R0.05	R0.10	R0.25	R0.50	R5	R10	
R0.10	R0.20	R0.50	R1	R10	R20	
R0.50	R1	R2.50	R5	R50	R100	
R1	R2	R5	R10	R100	R200	
EU						
1	2	3	4	5	6	
€0.01	€0.02	€0.05	€0.10	€1	€2	
€0.05	€0.10	€0.25	€0.50	€5	€10	
€0.10	€0.20	€0.50	€1	€10	€20	
€0.50	€1	€2.50	€5	€50	€100	
€1	€2	€5	€10	€100	€200	

**BET CONFIGURATIONS**

- 1, 2, 3, 4, 5
- 1, 2, 3, 5, 8
- 1, 2, 3, 5, 10

**MAX BET**

- 250, 400, 500 (Denomination 1, 2, 3, 4)
- 125, 200, 250 (Denomination 4)
- 25, 40, 50 (Denomination 4, 5, 6)

# FORTUNE FRAME™

## DRAGON BOUNTY

# FORTUNE FRAME™

## PANDA CARNIVAL

**FORTUNE FRAME™**  
**GRAND JACKPOT**  
**\$10,000.01**  
**MAJOR JACKPOT**  
**\$501.95**

**FORTUNE FRAME™**  
**GRAND JACKPOT**  
**\$10,000.03**  
**MAJOR JACKPOT**  
**\$500.59**

MINOR BONUS **\$25.00** MINI BONUS **\$10.00**  
  
**DRAGON BOUNTY**  
 RANDOM WILD IN FREE GAMES

MINOR BONUS **\$25.00** MINI BONUS **\$10.00**  
  
**PANDA CARNIVAL**  
 RANDOM WILD IN FREE GAMES

ANY 4 OR MORE • TRIGGER CASH SPIN FEATURE



CREDIT 2000 BET 88 WIN 0

ANY 4 OR MORE • TRIGGER CASH SPIN FEATURE



CREDIT 2000 BET 440 WIN 0







Collect more for more prizes. Random appearing in any symbol position boost your excitement. In Cash Spin, each spin awards prizes or an additional +1 spin. In Free Games, WILD randomly appear, becoming a multiplier and granting even bigger wins. GRAND JACKPOT or MAJOR JACKPOT can also be randomly won in bought games.

### CASH SPIN



Any 6 or more in a bought game trigger the CASH SPIN FEATURE. When the CASH SPIN FEATURE is triggered, 5 free spins are awarded. All appearing in the game that triggers the CASH SPIN FEATURE become that are held in position on the reels for the duration of the CASH SPIN FEATURE. There is a chance in each free spin that 1 is added to a random symbol position that does not already contain a held and is held in position until the CASH SPIN FEATURE ends. Each spin, any prize appearing within a is won. CASH SPIN FEATURE starts after the FREE GAMES FEATURE ends if triggered in the same bought game. CASH SPIN FEATURE ends after all awarded free spins have been played. All are removed when the CASH SPIN FEATURE ends.

### FREE GAMES



Any 3 appearing on reels 2, 3 and 4 trigger the FREE GAMES FEATURE with 7 free games. In each free game, there is a chance that one or more symbol positions randomly become or . The sum of multipliers from every / / / that substitutes in a win multiplies the pay for that win. Any appearing in the same position as / / / / is valid and displayed alternately if part of scatter win. During the FREE GAMES FEATURE, any 3 appearing on reels 2, 3 and 4 awards 5 additional free games.

### JACKPOT SURPRISE



There is a chance that 1 of the following prizes is randomly won in bought games except when FREE GAMES FEATURE or CASH SPIN FEATURE is triggered.

- GRAND JACKPOT
- MAJOR JACKPOT



### TYPE OF FEATURES

Free Game + LP

### REEL CONFIGURATION

5-Reel 3-Row Video Slot

### PAYLINES

243 Ways

### DENOMINATIONS

#### SA

1	2	3	4	5	6
R0.01	R0.02	R0.05	R0.10	R1	R2
R0.02	R0.05	R0.10	R0.20	R0.50	R1
R0.05	R0.10	R0.20	R0.50	R1	R2
R0.05	R0.10	R0.20	R0.50	R1	R10
R0.10	R0.20	R0.50	R1	R2	R5
R0.20	R0.50	R1	R2	R5	R10
R0.50	R1	R2	R5	R10	R20
R1	R2	R5	R10	R20	R50
R2	R5	R10	R20	R100	R200
R10	R20	R50	R100	R500	R1000

#### EU

1	2	3	4	5	6
€0.01	€0.02	€0.05	€0.10	€1	€2
€0.02	€0.05	€0.10	€0.20	€0.50	€1
€0.05	€0.10	€0.20	€0.50	€1	€2
€0.05	€0.10	€0.20	€0.50	€1	€10
€0.10	€0.20	€0.50	€1	€2	€5
€0.20	€0.50	€1	€2	€5	€10
€0.50	€1	€2	€5	€10	€20
€1	€2	€5	€10	€20	€50
€2	€5	€10	€20	€100	€200
€10	€20	€50	€100	€500	€1000

### BET CONFIGURATIONS

1, 2, 3, 4, 5

1, 2, 3, 4, 6

1, 2, 3, 5, 10

1, 2, 3, 6, 10

1, 2, 5, 10, 20

### MIN/MAX BET

8 Bet up to 1760 Bet

(Depends on the above Bet Configurations)



Collect more 🍀 for more prizes. Random 🍀 appearing in any symbol position boost your excitement. In Cash Spin, each spin awards prizes or an additional +1 spin. In Free Games, extra WILD appear granting even bigger wins. GRAND JACKPOT or MAJOR JACKPOT can also be randomly won in bought games.

**CASH SPIN**



Any 6 or more 🍀 in a bought game trigger the CASH SPIN FEATURE.

When the CASH SPIN FEATURE is triggered, 5 free spins are awarded.

All 🍀 appearing in the game that triggers the CASH SPIN FEATURE become 🍀 that are held in position on the reels for the duration of the CASH SPIN FEATURE.

There is a chance in each free spin that 1 🍀 is added to a random symbol position that does not already contain a held 🍀 and is held in position until the CASH SPIN FEATURE ends.

Each spin, any prize appearing within a 🍀 is won.

CASH SPIN FEATURE starts after the FREE GAMES FEATURE ends if triggered in the same bought game.

CASH SPIN FEATURE ends after all awarded free spins have been played.

All 🍀 are removed when the CASH SPIN FEATURE ends.

**FREE GAMES**



Any 3 🍀 appearing on reels 2, 3 and 4 trigger the FREE GAMES FEATURE with 7 free games.

In each free game, there is a chance that one or more symbol positions randomly become 🍀.

Any 🍀 appearing in the same position as 🍀 is valid and displayed alternately if part of scatter win.

During the FREE GAMES FEATURE, any 3 🍀 appearing on reels 2, 3 and 4 awards 5 additional free games.

**JACKPOT SURPRISE**



There is a chance that 1 of the following prizes is randomly won in bought games except when FREE GAMES FEATURE or CASH SPIN FEATURE is triggered.

- GRAND JACKPOT
- MAJOR JACKPOT

**TYPE OF FEATURES**

Free Game + LP

**REEL CONFIGURATION**

5-Reel 3-Row Video Slot

**PAYLINES**

243 Ways

**DENOMINATIONS**

SA					
1	2	3	4	5	6
R0.01	R0.02	R0.05	R0.10	R1	R2
R0.02	R0.05	R0.10	R0.20	R0.50	R1
R0.05	R0.10	R0.20	R0.50	R1	R2
R0.05	R0.10	R0.20	R0.50	R1	R10
R0.10	R0.20	R0.50	R1	R2	R5
R0.20	R0.50	R1	R2	R5	R10
R0.50	R1	R2	R5	R10	R20
R1	R2	R5	R10	R20	R50
R2	R5	R10	R20	R100	R200
R10	R20	R50	R100	R500	R1000

EU					
1	2	3	4	5	6
€0.01	€0.02	€0.05	€0.10	€1	€2
€0.02	€0.05	€0.10	€0.20	€0.50	€1
€0.05	€0.10	€0.20	€0.50	€1	€2
€0.05	€0.10	€0.20	€0.50	€1	€10
€0.10	€0.20	€0.50	€1	€2	€5
€0.20	€0.50	€1	€2	€5	€10
€0.50	€1	€2	€5	€10	€20
€1	€2	€5	€10	€20	€50
€2	€5	€10	€20	€100	€200
€10	€20	€50	€100	€500	€1000

**BET CONFIGURATIONS**

- 1, 2, 3, 4, 5
- 1, 2, 3, 4, 6
- 1, 2, 3, 5, 10
- 1, 2, 3, 6, 10
- 1, 2, 5, 10, 20

**MIN/MAX BET**

8 Bet up to 1760 Bet  
(Depends on the above Bet Configurations)

# DANCING PANDA SUPREME FESTIVAL

# DANCING PANDA SUPREME FORTUNE





Happy blessings come from wild surprises. During free games, multiple symbol kinds on all reels may randomly become wild symbols and line wins may be multiplied by randomly appearing multiplier wild symbols. The all-new FUSION FEATURE may award multipliers on bonus symbols making all prizes be multiplied for extravagant amount of prizes.

### FREE GAMES FEATURE



Any 3 or more trigger the FREE GAMES. FREE GAMES consist of 8 FREE GAMES.

During FREE GAMES, any 3 or more award 5 additional free games.

FREE GAMES start after the FUSION FEATURE ends if triggered in the same game. If the FUSION FEATURE is triggered during the FREE GAMES, any remaining free games resume after the FUSION FEATURE ends.

### RANDOM WILD

There is a chance RANDOM WILD is triggered during the FREE GAMES only.

In the game that RANDOM WILD occurs, one or more symbol positions randomly become a substitute symbol as described in the sequence below.

- : If randomly appears in a symbol position.
- : If randomly appears in a symbol position that already randomly became .

If randomly appears in the same symbol position as a on a reel strip, only the randomly appearing is valid.

Every substituting in a win multiplies the pay for that win. Any scatter appearing in the same position as / is valid and displayed alternately if part of scatter win. In the spin that RANDOM WILD occurs, all wins are determined after all randomly selected symbol positions have become their determined symbol on stopped reels.

### FUSION FEATURE



Any 6 or more in a bought game or a FREE GAME trigger the FUSION FEATURE.

When the FUSION FEATURE is triggered, 3 free spins are awarded.

Any appearing in the game that triggers the FUSION FEATURE become in the FUSION FEATURE.

Any symbol position or FUSION FEATURE REEL PATTERN during the FUSION FEATURE are held in position on the reels for the duration of the FUSION FEATURE. During the FUSION FEATURE free spins, each symbol position or FUSION FEATURE REEL PATTERN formed becomes an individual bonus reel. Any newly appearing in the FUSION FEATURE resets the number of remaining free spins to 3. FUSION FEATURE ends after all awarded free spins have been played or if all symbol positions are filled with / / .

### JACKPOT SURPRISE



There is a chance that GRAND JACKPOT is randomly won in any bought game, except in the game that FUSION FEATURE is triggered.

### TYPE OF FEATURES

Free Game + LP

### REEL CONFIGURATION

5-Reel 3-Row Video Slot

### PAYLINES

10, 20, 25, 30, 50 Lines (Denomination 1, 2)

5, 10, 15, 20, 25 Lines (Denomination 3, 4, 5)

1, 2, 3, 4, 5 Lines (Denomination 6, 7)

### DENOMINATIONS

#### SA

1	2	3	4	5	6	7
R0.01	R0.02	R0.05	R0.10	R0.20	R1	R2
R0.05	R0.10	R0.25	R0.50	R1	R5	R10
R0.10	R0.20	R0.50	R1	R2	R10	R20
R0.50	R1	R2.50	R5	R10	R50	R100
R1	R2	R5	R10	R20	R100	R200

#### EU

1	2	3	4	5	6	7
€0.01	€0.02	€0.05	€0.10	€0.20	€1	€2
€0.05	€0.10	€0.25	€0.50	€1	€5	€10
€0.10	€0.20	€0.50	€1	€2	€10	€20
€0.50	€1	€2.50	€5	€10	€50	€100
€1	€2	€5	€10	€20	€100	€200

### BET CONFIGURATIONS

1, 2, 3, 4, 5

1, 2, 3, 5, 8

1, 2, 3, 5, 10

1, 2, 5, 10, 20

### MAX BET

250, 400, 500, 1000 (Denomination 1, 2)

125, 200, 250, 500 (Denomination 3, 4, 5)

25, 40, 50, 100 (Denomination 6, 7)



Happy blessings come from wild surprises. During free games, multiple symbol kinds on all reels may randomly become wild symbols and line wins may be multiplied by randomly appearing multiplier wild symbols. The all-new FUSION FEATURE may award multipliers on bonus symbols making all prizes be multiplied for extravagant amount of prizes.

**FREE GAMES FEATURE**



Any 3 or more trigger the FREE GAMES in bought games only. FREE GAMES consist of 7 FREE GAMES. During FREE GAMES, each awards 1, 2 or 3 additional free games, randomly. FREE GAMES cannot be triggered again during the FREE GAMES. FREE GAMES start after the FUSION FEATURE ends if triggered in the same game. If the FUSION FEATURE is triggered during the FREE GAMES, any remaining free games resume after the FUSION FEATURE ends.

**RANDOM WILD**

There is a chance RANDOM WILD is triggered during the FREE GAMES only. In the game that RANDOM WILD occurs, one or more symbol positions randomly become a substitute symbol as described in the sequence below.

- : If randomly appears in a symbol position.
- : If randomly appears in a symbol position that already randomly became .

If randomly appears in the same symbol position as a on a reel strip, only the randomly appearing is valid. Every substituting in a win multiplies the pay for that win. Any scatter appearing in the same position as / is valid and displayed alternately if part of scatter win. RANDOM WILD and CHANGE UP cannot be triggered in the same free game. In the spin that RANDOM WILD occurs, all wins are determined after all randomly selected symbol positions have become their determined symbol on stopped reels.

**CHANGE UP**

There is a chance CHANGE UP is triggered during the FREE GAMES only. In the spin that CHANGE UP occurs, all on the reels change to 1 of the following symbols: or . CHANGE UP and RANDOM WILD cannot be triggered in the same free game. In the spin that CHANGE UP occurs, all wins are determined after all symbols have changed to their determined symbol on stopped reels.

**FUSION FEATURE**



Any 6 or more in a bought game or a FREE GAME trigger the FUSION FEATURE. When the FUSION FEATURE is triggered, 3 free spins are awarded. Any appearing in the game that triggers the FUSION FEATURE become in the FUSION FEATURE. Any symbol position or FUSION FEATURE REEL PATTERN during the FUSION FEATURE are held in position on the reels for the duration of the FUSION FEATURE. During the FUSION FEATURE free spins, each symbol position or FUSION FEATURE REEL PATTERN formed becomes an individual bonus reel. Any newly appearing in the FUSION FEATURE resets the number of remaining free spins to 3. FUSION FEATURE ends after all awarded free spins have been played or if all symbol positions are filled with / / .

**JACKPOT SURPRISE**



There is a chance that GRAND JACKPOT is randomly won in any bought game, except in the game that FUSION FEATURE is triggered.



**TYPE OF FEATURES**

Free Game + LP

**REEL CONFIGURATION**

5-Reel 3-Row Video Slot

**PAYLINES**

10, 20, 25, 30, 50 Lines (Denomination 1, 2)  
5, 10, 15, 20, 25 Lines (Denomination 3, 4, 5)  
1, 2, 3, 4, 5 Lines (Denomination 6, 7)

**DENOMINATIONS**

SA							
1	2	3	4	5	6	7	
R0.01	R0.02	R0.05	R0.10	R0.20	R1	R2	
R0.05	R0.10	R0.25	R0.50	R1	R5	R10	
R0.10	R0.20	R0.50	R1	R2	R10	R20	
R0.50	R1	R2.50	R5	R10	R50	R100	
R1	R2	R5	R10	R20	R100	R200	
EU							
1	2	3	4	5	6	7	
€0.01	€0.02	€0.05	€0.10	€0.20	€1	€2	
€0.05	€0.10	€0.25	€0.50	€1	€5	€10	
€0.10	€0.20	€0.50	€1	€2	€10	€20	
€0.50	€1	€2.50	€5	€10	€50	€100	
€1	€2	€5	€10	€20	€100	€200	

**BET CONFIGURATIONS**

1, 2, 3, 4, 5  
1, 2, 3, 5, 8  
1, 2, 3, 5, 10  
1, 2, 5, 10, 20

**MAX BET**

250, 400, 500, 1000 (Denomination 1, 2)  
125, 200, 250, 500 (Denomination 3, 4, 5)  
25, 40, 50, 100 (Denomination 6, 7)

# TOMB TREASURE™





Dare to explore the hidden riches of lore. Win all prizes shown on collected bonus symbols and get extra free spins in any spin of the collect feature in which a new bonus symbol appears. Prizes on bonus symbols are determined by a changing prize map that mirrors the reels with each new bonus symbol displaying the sum of all prizes collected in previous spins. Grand Jackpot is won when 15 bonus symbols are collected or it is won randomly in bought games. Free games use reels with extra wild symbols.

### FREE GAMES FEATURE



Any 3 appearing on reels 2, 3 and 4 trigger the FREE GAMES FEATURE with 8 free games. Reels used during the FREE GAMES FEATURE contain a greater total number of . FREE GAMES FEATURE can be triggered again during the FREE GAMES FEATURE. FREE GAMES FEATURE starts after the PYRAMID FEATURE ends if triggered in the same game. If PYRAMID FEATURE is triggered during the FREE GAMES FEATURE, any remaining free games resume after the PYRAMID FEATURE ends.

### PYRAMID FEATURE



Any 6 or more trigger the PYRAMID FEATURE and are held in position on the reels for the duration of the PYRAMID FEATURE. PYRAMID FEATURE consists of 3 free spins. During the PYRAMID FEATURE, each symbol position that does not contain a held becomes an individual spinning bonus reel. In the PYRAMID FEATURE, a prize map corresponding to the 15 symbol positions on the reels is displayed above the reels. While a is held on the reels, the prize in the corresponding location on the prize map is also held. Before the first free spin, each held on the reels displays the prize from the corresponding location on the prize map. Each new appearing in a free spin resets the number of remaining free spins to 3 and is held in position for the duration of the PYRAMID FEATURE. PYRAMID FEATURE ends after all awarded free spins have been played or if appear in all 15 symbol positions.

### MYSTERY PRIZE



There is a chance that the GRAND JACKPOT is randomly won in bought games except when FREE GAMES FEATURE or PYRAMID FEATURE is triggered. The contribution amount that exceeds the jackpot upper limit is added to the next JACKPOT.



### TYPE OF FEATURES

Free Game + LP

### REEL CONFIGURATION

5-Reel 3-Row Video Slot

### PAYLINES

10, 25, 50 Lines (Denomination 1, 2)  
5, 10, 25 Lines (Denomination 3, 4, 5)  
5 Lines (Denomination 6, 7, 8)

### DENOMINATIONS

#### SA

1	2	3	4	5	6	7	8
R0.01	R0.02	R0.05	R0.10	R0.20	R1	R2	R5
R0.05	R0.10	R0.25	R0.50	R1	R5	R10	R25
R0.10	R0.20	R0.50	R1	R2	R10	R20	R50
R0.50	R1	R2.50	R5	R10	R50	R100	R250
R1	R2	R5	R10	R20	R100	R200	R500

#### EU

1	2	3	4	5	6	7	8
€0.01	€0.02	€0.05	€0.10	€0.20	€1	€2	€5
€0.05	€0.10	€0.25	€0.50	€1	€5	€10	€25
€0.10	€0.20	€0.50	€1	€2	€10	€20	€50
€0.50	€1	€2.50	€5	€10	€50	€100	€250
€1	€2	€5	€10	€20	€100	€200	€500

### BET CONFIGURATIONS

1, 2, 3, 4, 5  
1, 2, 3, 5, 8  
1, 2, 3, 5, 10  
1, 2, 5, 10, 20

### MAX BET

250, 400, 500, 1000 (Denomination 1, 2)  
125, 200, 250, 500 (Denomination 3, 4, 5)  
25, 40, 50, 100 (Denomination 6, 7, 8)



Dare to explore the hidden riches of lore. Win all prizes shown on collected bonus symbols and get extra free spins in any spin of the collect feature in which a new bonus symbol appears. Prizes on bonus symbols are determined by a changing prize map that mirrors the reels with each new bonus symbol displaying the sum of all prizes collected in previous spins. Grand Jackpot is won when 15 bonus symbols are collected or it is won randomly in bought games. Free games use reels with extra bonus symbols.

### FREE GAMES FEATURE



Any 3 appearing on reels 2, 3 and 4 trigger the FREE GAMES FEATURE with 6 free games.

Reels used during the FREE GAMES FEATURE contain a greater total number of .

FREE GAMES FEATURE can be triggered again during the FREE GAMES FEATURE.

FREE GAMES FEATURE starts after the PYRAMID FEATURE ends if triggered in the same game.

If PYRAMID FEATURE is triggered during the FREE GAMES FEATURE, any remaining free games resume after the PYRAMID FEATURE ends.

### PYRAMID FEATURE



Any 6 or more trigger the PYRAMID FEATURE and are held in position on the reels for the duration of the PYRAMID FEATURE. PYRAMID FEATURE consists of 3 free spins.

During the PYRAMID FEATURE, each symbol position that does not contain a held becomes an individual spinning bonus reel.

In the PYRAMID FEATURE, a prize map corresponding to the 15 symbol positions on the reels is displayed above the reels.

While a is held on the reels, the prize in the corresponding location on the prize map is also held.

Before the first free spin, each held on the reels displays the prize from the corresponding location on the prize map.

Each new appearing in a free spin resets the number of remaining free spins to 3 and is held in position for the duration of the PYRAMID FEATURE.

PYRAMID FEATURE ends after all awarded free spins have been played or if appear in all 15 symbol positions.

### MYSTERY PRIZE



There is a chance that the GRAND JACKPOT is randomly won in bought games except when FREE GAMES FEATURE or PYRAMID FEATURE is triggered.

The contribution amount that exceeds the jackpot upper limit is added to the next JACKPOT.

### TYPE OF FEATURES

Free Game + LP

### REEL CONFIGURATION

5-Reel 3-Row Video Slot

### PAYLINES

10, 25, 50 Lines (Denomination 1, 2)  
5, 10, 25 Lines (Denomination 3, 4, 5)  
5 Lines (Denomination 6, 7, 8)

### DENOMINATIONS

#### SA

1	2	3	4	5	6	7	8
R0.01	R0.02	R0.05	R0.10	R0.20	R1	R2	R5
R0.05	R0.10	R0.25	R0.50	R1	R5	R10	R25
R0.10	R0.20	R0.50	R1	R2	R10	R20	R50
R0.50	R1	R2.50	R5	R10	R50	R100	R250
R1	R2	R5	R10	R20	R100	R200	R500

#### EU

1	2	3	4	5	6	7	8
€0.01	€0.02	€0.05	€0.10	€0.20	€1	€2	€5
€0.05	€0.10	€0.25	€0.50	€1	€5	€10	€25
€0.10	€0.20	€0.50	€1	€2	€10	€20	€50
€0.50	€1	€2.50	€5	€10	€50	€100	€250
€1	€2	€5	€10	€20	€100	€200	€500

### BET CONFIGURATIONS

1, 2, 3, 4, 5  
1, 2, 3, 5, 8  
1, 2, 3, 5, 10  
1, 2, 5, 10, 20

### MAX BET

250, 400, 500, 1000 (Denomination 1, 2)  
125, 200, 250, 500 (Denomination 3, 4, 5)  
25, 40, 50, 100 (Denomination 6, 7, 8)





Dare to explore the hidden riches of lore. Win all prizes shown on collected bonus symbols and get extra free spins in any spin of the collect feature in which a new bonus symbol appears. Prizes on bonus symbols are determined by a changing prize map that mirrors the reels with each new bonus symbol displaying the sum of all prizes collected in previous spins. Grand Jackpot is won when 15 bonus symbols are collected or it is won randomly in bought games. Free games use reels with extra wild symbols.

### FREE GAMES FEATURE



Any 3 appearing on reels 2, 3 and 4 trigger the FREE GAMES FEATURE with 8 free games. Reels used during the FREE GAMES FEATURE contain a greater total number of . FREE GAMES FEATURE can be triggered again during the FREE GAMES FEATURE. FREE GAMES FEATURE starts after the PYRAMID FEATURE ends if triggered in the same game. If PYRAMID FEATURE is triggered during the FREE GAMES FEATURE, any remaining free games resume after the PYRAMID FEATURE ends.

### PYRAMID FEATURE



Any 6 or more trigger the PYRAMID FEATURE and are held in position on the reels for the duration of the PYRAMID FEATURE. PYRAMID FEATURE consists of 3 free spins. During the PYRAMID FEATURE, each symbol position that does not contain a held becomes an individual spinning bonus reel. In the PYRAMID FEATURE, a prize map corresponding to the 15 symbol positions on the reels is displayed above the reels. While a is held on the reels, the prize in the corresponding location on the prize map is also held. Before the first free spin, each held on the reels displays the prize from the corresponding location on the prize map. Each new appearing in a free spin resets the number of remaining free spins to 3 and is held in position for the duration of the PYRAMID FEATURE. PYRAMID FEATURE ends after all awarded free spins have been played or if appear in all 15 symbol positions.

### MYSTERY PRIZE



There is a chance that the GRAND JACKPOT is randomly won in bought games except when FREE GAMES FEATURE or PYRAMID FEATURE is triggered. The contribution amount that exceeds the jackpot upper limit is added to the next JACKPOT.



### TYPE OF FEATURES

Free Game + LP

### REEL CONFIGURATION

5-Reel 3-Row Video Slot

### PAYLINES

10, 25, 50 Lines (Denomination 1, 2)  
5, 10, 25 Lines (Denomination 3, 4, 5)  
5 Lines (Denomination 6, 7, 8)

### DENOMINATIONS

#### SA

1	2	3	4	5	6	7	8
R0.01	R0.02	R0.05	R0.10	R0.20	R1	R2	R5
R0.05	R0.10	R0.25	R0.50	R1	R5	R10	R25
R0.10	R0.20	R0.50	R1	R2	R10	R20	R50
R0.50	R1	R2.50	R5	R10	R50	R100	R250
R1	R2	R5	R10	R20	R100	R200	R500

#### EU

1	2	3	4	5	6	7	8
€0.01	€0.02	€0.05	€0.10	€0.20	€1	€2	€5
€0.05	€0.10	€0.25	€0.50	€1	€5	€10	€25
€0.10	€0.20	€0.50	€1	€2	€10	€20	€50
€0.50	€1	€2.50	€5	€10	€50	€100	€250
€1	€2	€5	€10	€20	€100	€200	€500

### BET CONFIGURATIONS

1, 2, 3, 4, 5  
1, 2, 3, 5, 8  
1, 2, 3, 5, 10  
1, 2, 5, 10, 20

### MAX BET

250, 400, 500, 1000 (Denomination 1, 2)  
125, 200, 250, 500 (Denomination 3, 4, 5)  
25, 40, 50, 100 (Denomination 6, 7, 8)

# Speed

Entertainment has a classy new look.

Players can enjoy an exciting gaming experience.

Optimal service design for accessibility and maintenance.



### Stunning HD Graphics

An LCD monitor with dual 27-inch LCD high definition monitor.



### Immersive Audio

Newly designed sound system creates powerful theater-like sound.



### USB charging

USB charging port & wireless Charger also provided for player convenience.



### Ergonomic button deck

Premium Speed 11.6-inch LCD Touch Screen panel with Bash Button.



## DIMENSION

(with Custom Stand Base version)

### Upright Height

(Tower Light Included)

2461.7 mm (96.92 in)

### Upright Height

(Tower Light Excluded)

2353.7 mm (92.67 in)

### Width

680 mm (26.77 in)

### Depth

631 mm (24.84 in)

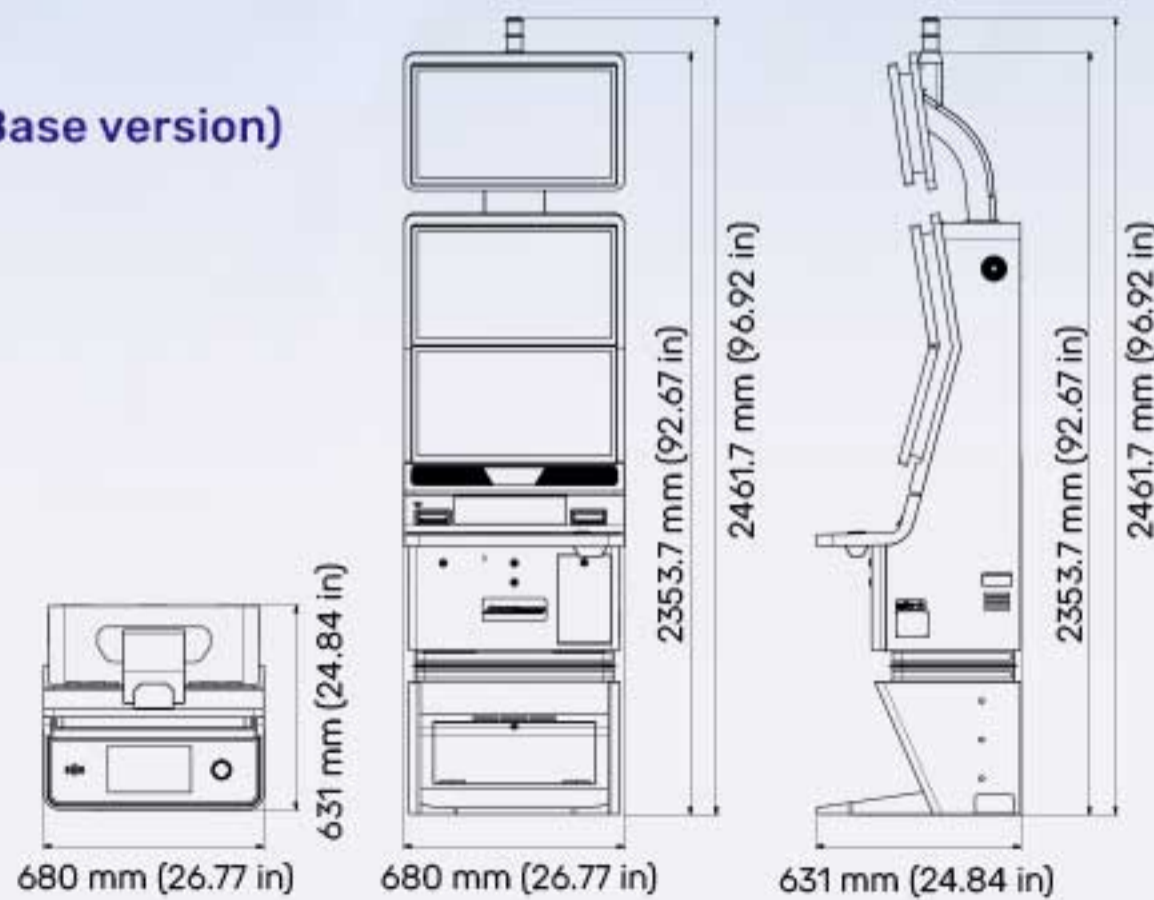

# Orb of Wealth™

**Orb of Wealth**  
**GRAND**  
**\$10,000.00**  
**MAJOR**  
**\$800.00**

**Orb of Wealth**  
**GRAND**  
**\$10,000.00**  
**MAJOR**  
**\$800.00**

**MINOR** \$25.00 **MINI** \$10.00  
**ROYALS REMOVED IN FREE GAMES**



6 or more trigger FREE GAMES

1c CREDIT 0 MAX 88 WIN 0

**MINOR** \$25.00 **MINI** \$10.00  
**SHINING FORTUNE** **FREE GAMES**



6 or more trigger FREE GAMES

1c CREDIT 0 MAX 88 WIN 0



**ARCADE**



**ARCADE**



**ARCADE**



**ARCADE**



Powerful repeating wins when fate and luck combine. Special scatter symbols trigger the free games feature in which the sum of credit prizes displayed on these triggering symbols is paid for each scatter that appears during the free games. When one or more wild symbols appear in a bought game, there is a chance to trigger the jackpot feature containing four progressive levels.

### JACKPOT FEATURE



### TYPE OF FEATURES

Free Game + LP

### REEL CONFIGURATION

5-Reel 3-Row Video Slot

### PAYLINES

243 Ways

### DENOMINATIONS

SA R0.10

EU €0.01

### BET CONFIGURATIONS

1, 2, 3, 4, 5, 6, 7, 8, 9, 10

### MAX BET

88 Bet to 880 Bet

(Depends on the above Bet Configurations)

There is a chance that the JACKPOT FEATURE may be triggered when 1 or more **WILD** appear in bought games only.

In the JACKPOT FEATURE, there are 4 types of jackpot symbols hidden behind 12 icons.

Select an icon until 3 matching jackpot symbols corresponding to a JACKPOT are revealed.

### FREE GAMES FEATURE



Any 6 or more **Orb of Wealth** in a bought game trigger 6 free games.

Each **Orb of Wealth** that appears during the free games pays the ORB PRIZE.

Before the free games start, the ORB PRIZE credit amount is determined as the sum of numbers that are displayed on all **Orb of Wealth** appearing in the bought game that triggered the free games.

Royal symbols do not appear in free games.



Powerful repeating wins when fate and luck combine. Special scatter symbols trigger the free games feature in which the sum of credit prizes displayed on these triggering symbols is paid for each scatter that appears during the free games. When one or more wild symbols appear in a bought game, there is a chance to trigger the jackpot feature containing four progressive levels.

### JACKPOT FEATURE



There is a chance that the JACKPOT FEATURE may be triggered when 1 or more **WILD** appear in bought games only.

In the JACKPOT FEATURE, there are 4 types of jackpot symbols hidden behind 12 icons. Select an icon until 3 matching jackpot symbols corresponding to a JACKPOT are revealed.

### FREE GAMES FEATURE



Any 6 or more **ORBS** in a bought game trigger 6 free games.

Each **ORBS** that appears during the free games pays the ORB PRIZE.

Each **SCATTER** that appears during the free games awards 1 additional free game.

Before the free games start, the ORB PRIZE credit amount is determined as the sum of numbers that are displayed on all **ORBS** appearing in the bought game that triggered the free games.



### TYPE OF FEATURES

Free Game + LP

### REEL CONFIGURATION

5-Reel 3-Row Video Slot

### PAYLINES

243 Ways

### DENOMINATIONS

**SA** R0.10

**EU** €0.01

### BET CONFIGURATIONS

1, 2, 3, 4, 5, 6, 7, 8, 9, 10

### MAX BET

88 Bet to 880 Bet

(Depends on the above Bet Configurations)

# BOUND FOR RICHES™



## EGYPTIAN MAJESTY

## AZTEC LEGEND

## CHINESE CELEBRATION

## SPANISH MATADOR

### TYPE OF FEATURES

Free Game + LP

### REEL CONFIGURATION

5-Reel 3-Row Video Slot

### PAYLINES

50 Lines (Denomination 1 & 2)

25 Lines (Denomination 3 & 4)

5 Lines (Denomination 5 & 6)

### DENOMINATIONS

SA					
1	2	3	4	5	6
R0.01	R0.02	R0.05	R0.10	R1	R2
R0.02	R0.05	R0.10	R0.20	R2	R5
R0.05	R0.10	R0.25	R0.50	R5	R10
R0.10	R0.20	R0.50	R1	R10	R20
R0.20	R0.50	R1	R2	R20	R50
R0.50	R1	R2.50	R5	R50	R100
R1	R2	R5	R10	R100	R200
R0.01	R0.02	R0.05	R0.10		
R0.02	R0.05	R0.10	R0.20		
R0.05	R0.10	R0.25	R0.50		
R0.10	R0.20	R0.50	R1		
R0.20	R0.50	R1	R2		
R0.50	R1	R2.50	R5		
R1	R2	R5	R10		
R5	R10	R25	R50		
R10	R20	R50	R100		

EU					
1	2	3	4	5	6
€0.01	€0.02	€0.05	€0.10	€1	€2
€0.02	€0.05	€0.10	€0.20	€2	€5
€0.05	€0.10	€0.25	€0.50	€5	€10
€0.10	€0.20	€0.50	€1	€10	€20
€0.20	€0.50	€1	€2	€20	€50
€0.50	€1	€2.50	€5	€50	€100
€1	€2	€5	€10	€100	€200
€0.01	€0.02	€0.05	€0.10		
€0.02	€0.05	€0.10	€0.20		
€0.05	€0.10	€0.25	€0.50		
€0.10	€0.20	€0.50	€1		
€0.20	€0.50	€1	€2		
€0.50	€1	€2.50	€5		
€1	€2	€5	€10		
€5	€10	€25	€50		
€10	€20	€50	€100		

### BET CONFIGURATIONS

1, 2, 3, 4, 5

1, 2, 3, 5, 10

### MAX BET

250, 500 (Denomination 1 & 2)

125, 250 (Denomination 3 & 4)

25, 50 (Denomination 5 & 6)

Choo! Choo! Hop on board the golden express destined for cash and prizes. All prizes displayed on special scatter symbols that are held during the collect feature are won, including bonus and jackpot prizes. When the special scatters fill the reels in any game, additional prizes including bonuses and jackpots are won in a pick game. Additionally, jackpots may be won randomly during bought games.

### BOUND FOR RICHES EGYPTIAN MAJESTY

3 or more scattered trigger 9 FREE GAMES. During FREE GAMES, appearing on reels 2, 3, 4 or 5 nudges to show 3 stacked .

### BOUND FOR RICHES AZTEC LEGEND

3 or more scattered trigger 9 FREE GAMES. Reels 2, 3, 4 and 5 contain extra during the FREE GAMES and any retriggered FREE GAMES.

### BOUND FOR RICHES CHINESE CELEBRATION

3 or more scattered trigger 6 FREE GAMES. appears during FREE GAMES only.

appearing on the reels changes to or .

All appearing in the same FREE GAME randomly change to the same symbol. If appears, wins are determined after finishes changing.

During FREE GAMES, 3 or more scattered award 3 additional FREE GAMES.

### BOUND FOR RICHES SPANISH MATADOR

3 or more scattered trigger 6 FREE GAMES. During FREE GAMES, 3 or more scattered award 3 additional FREE GAMES.

### COLLECT FEATURE

1 appearing in a bought game or during the FREE GAMES triggers the COLLECT FEATURE and is held for the duration of the COLLECT FEATURE.

Any appearing in the same bought game with are also held for the duration of the COLLECT FEATURE.

When the COLLECT FEATURE is triggered, 2 free spins are awarded.

Each new that appears during the COLLECT FEATURE awards 2 additional free spins and is held in position until the COLLECT FEATURE ends.



### PRIZE PICK FEATURE

During bought games or the COLLECT FEATURE, any combination of 15 / appearing on the reels trigger the PRIZE PICK FEATURE.

In the PRIZE PICK FEATURE, pick from among 10 displayed on the game screen and win each prize revealed.

The number of picks that can be made is equal to the credits bet per line in the game that triggered the PRIZE PICK FEATURE, COLLECT FEATURE or FREE GAMES.



# CO CO CO COIN™

EGYPTIAN TREASURE

# CO CO CO COIN™

PIRATES TREASURE







Wild keys of fortune possess the power to unlock golden riches. Jackpot, bonus and credit prizes on gold coins are won when appearing in any position on 3 or more consecutive reels beginning with the leftmost reel. More coins appear on the first three reels during free games and even more coins appear on all reels in a respin that is triggered randomly when wild appears during bought games.

### TREASURE RESPIN



There is a chance that a TREASURE RESPIN is randomly triggered when 1 or more appear in bought spins only.

After all wins are determined in the bought spin that triggers the TREASURE RESPIN, all reels respin automatically in one free spin and any new wins are added.

Different reels with extra on reels 1, 2, 3, 4 and 5 are used in the TREASURE RESPIN.

TREASURE RESPIN cannot be triggered again in the TREASURE RESPIN.

### FREE GAMES FEATURE



Any 3 or more trigger the FREE GAMES FEATURE awarding 10 FREE GAMES. Reels 1, 2 and 3 contain extra during the FREE GAMES FEATURE compared to bought games.

FREE GAMES FEATURE can be triggered again during the FREE GAMES FEATURE.

If the FREE GAMES FEATURE and TREASURE RESPIN are triggered in the same bought spin, the FREE GAMES FEATURE starts after the TREASURE RESPIN.

If the FREE GAMES FEATURE is then triggered again in the TREASURE RESPIN, the sum of FREE GAMES awarded for the two triggered FREE GAMES FEATURES are played in a single FREE GAMES FEATURE that starts after the TREASURE RESPIN ends.

### JACKPOT AND BONUS PRIZES



are special bonus symbols that are excluded from wins. Prizes displayed on are paid one time only for all appearing in any position on 3 or more consecutive reels beginning with the leftmost reel.

Each displays 1 of the available prizes below:

- PRIZE AMOUNT: equal to the total credits bet multiplied by a randomly determined multiplier as displayed. Available multipliers correspond to the reel that appears on:
  - Reels 1 to 3: multipliers 1, 2, 3, 4, 5, 6, 8 and 10.
  - Reel 4: multipliers 1, 2, 3, 4, 5, 6, 8, 10, 15, 20, 30 and 40.
  - Reel 5: multipliers 1, 2, 3, 4, 5, 6, 8, 10, 15, 20, 30, 40, 50, 60, 100 and 200.
- MAJOR BONUS, MINOR BONUS or MINI BONUS
- GRAND JACKPOT or MEGA JACKPOT



### TYPE OF FEATURES

Free Game

### REEL CONFIGURATION

5-Reel 3-Row Video Slot

### PAYLINES

243 Ways

### DENOMINATIONS

#### SA

1	2	3	4	5	6
R0.01	R0.02	R0.05	R0.10	R1	R2
R0.05	R0.10	R0.25	R0.50	R5	R10
R0.10	R0.20	R0.50	R1	R10	R20
R0.50	R1	R2.50	R5	R50	R100
R1	R2	R5	R10	R100	R200
R0.01	R0.02	R0.05	R0.10		
R0.02	R0.05	R0.10	R0.20		
R0.05	R0.10	R0.25	R0.50		
R0.10	R0.20	R0.50	R1		
R0.20	R0.50	R1	R2		
R0.50	R1	R2.50	R5		
R1	R2	R5	R10		
R5	R10	R25	R50		
R10	R20	R50	R100		

#### EU

1	2	3	4	5	6
€0.01	€0.02	€0.05	€0.10	€1	€2
€0.05	€0.10	€0.25	€0.50	€5	€10
€0.10	€0.20	€0.50	€1	€10	€20
€0.50	€1	€2.50	€5	€50	€100
€1	€2	€5	€10	€100	€200
€0.01	€0.02	€0.05	€0.10		
€0.02	€0.05	€0.10	€0.20		
€0.05	€0.10	€0.25	€0.50		
€0.10	€0.20	€0.50	€1		
€0.20	€0.50	€1	€2		
€0.50	€1	€2.50	€5		
€1	€2	€5	€10		
€5	€10	€25	€50		
€10	€20	€50	€100		

### BET CONFIGURATIONS

1, 2, 3, 4, 5  
1, 2, 3, 5, 8  
1, 2, 3, 5, 10  
1, 2, 5, 10, 20

### MAX BET

250, 400, 500, 1000 (Denomination 1, 2)  
125, 200, 250, 500 (Denomination 3, 4)  
25, 40, 50, 100 (Denomination 5, 6)



## TYPE OF FEATURES

Free Game

## REEL CONFIGURATION

5-Reel 3-Row Video Slot

## PAYLINES

243 Ways

## DENOMINATIONS

### SA

1	2	3	4	5	6
R0.01	R0.02	R0.05	R0.10	R1	R2
R0.05	R0.10	R0.25	R0.50	R5	R10
R0.10	R0.20	R0.50	R1	R10	R20
R0.50	R1	R2.50	R5	R50	R100
R1	R2	R5	R10	R100	R200
R0.01	R0.02	R0.05	R0.10		
R0.02	R0.05	R0.10	R0.20		
R0.05	R0.10	R0.25	R0.50		
R0.10	R0.20	R0.50	R1		
R0.20	R0.50	R1	R2		
R0.50	R1	R2.50	R5		
R1	R2	R5	R10		
R5	R10	R25	R50		
R10	R20	R50	R100		

### EU

1	2	3	4	5	6
€0.01	€0.02	€0.05	€0.10	€1	€2
€0.05	€0.10	€0.25	€0.50	€5	€10
€0.10	€0.20	€0.50	€1	€10	€20
€0.50	€1	€2.50	€5	€50	€100
€1	€2	€5	€10	€100	€200
€0.01	€0.02	€0.05	€0.10		
€0.02	€0.05	€0.10	€0.20		
€0.05	€0.10	€0.25	€0.50		
€0.10	€0.20	€0.50	€1		
€0.20	€0.50	€1	€2		
€0.50	€1	€2.50	€5		
€1	€2	€5	€10		
€5	€10	€25	€50		
€10	€20	€50	€100		

## BET CONFIGURATIONS

1, 2, 3, 4, 5

1, 2, 3, 5, 8

1, 2, 3, 5, 10

1, 2, 5, 10, 20

## MAX BET

250, 400, 500, 1000 (Denomination 1, 2)

125, 200, 250, 500 (Denomination 3, 4)

25, 40, 50, 100 (Denomination 5, 6)



Wild keys of fortune possess the power to unlock golden riches. Jackpot, bonus and credit prizes on gold coins are won when appearing in any position on 3 or more consecutive reels beginning with the leftmost reel. More coins appear on the first three reels during free games and even more coins appear on all reels in a respin that is triggered randomly when wild appears during bought games.

## TREASURE RESPIN



There is a chance that a TREASURE RESPIN is randomly triggered when 1 or more appear in bought spins only.

After all wins are determined in the bought spin that triggers the TREASURE RESPIN, all reels respin automatically in one free spin and any new wins are added.

Different reels with extra on reels 1, 2, 3, 4 and 5 are used in the TREASURE RESPIN.

TREASURE RESPIN cannot be triggered again in the TREASURE RESPIN.

## FREE GAMES FEATURE



Any 3 or more trigger the FREE GAMES FEATURE awarding 10 FREE GAMES. Reels 1, 2 and 3 contain extra during the FREE GAMES FEATURE compared to bought games.

FREE GAMES FEATURE can be triggered again during the FREE GAMES FEATURE.

If the FREE GAMES FEATURE and TREASURE RESPIN are triggered in the same bought spin, the FREE GAMES FEATURE starts after the TREASURE RESPIN.

If the FREE GAMES FEATURE is then triggered again in the TREASURE RESPIN, the sum of FREE GAMES awarded for the two triggered FREE GAMES FEATURES are played in a single FREE GAMES FEATURE that starts after the TREASURE RESPIN ends.

## JACKPOT AND BONUS PRIZES



are special bonus symbols that are excluded from wins. Prizes displayed on are paid one time only for all appearing in any position on 3 or more consecutive reels beginning with the leftmost reel.

Each displays 1 of the available prizes below:

- PRIZE AMOUNT: equal to the total credits bet multiplied by a randomly determined multiplier as displayed. Available multipliers correspond to the reel that appears on:
  - Reels 1 to 3: multipliers 1, 2, 3, 4, 5, 6, 8 and 10.
  - Reel 4: multipliers 1, 2, 3, 4, 5, 6, 8, 10, 15, 20, 30 and 40.
  - Reel 5: multipliers 1, 2, 3, 4, 5, 6, 8, 10, 15, 20, 30, 40, 50, 60, 100 and 200.
- MAJOR BONUS, MINOR BONUS or MINI BONUS
- GRAND JACKPOT or MEGA JACKPOT

# DANCING PANDA™ FORTUNE

# DANCING PANDA™ FESTIVAL





Happy blessings come from wild surprises. During bought games and free games, multiple lower-paying symbol kinds on all reels may randomly become a single higher-paying symbol kind. Alternatively, line wins may be multiplied by randomly appearing multiplier wild symbols. When wild symbols appear, there is a chance to trigger a special prize reel that awards jackpots, free games or both. Multiple jackpots may be won on the special prize reel.

### RANDOM FEATURES

#### RANDOM WILD

RANDOM WILD randomly occurs during bought games and free games. All / substituting in a line win multiply the pay for that line only.

#### CHANGE UP

CHANGE UP randomly occurs during bought games and free games.

In the spin that CHANGE UP occurs, all **A, K, Q, J, 10** and **9** on the reels change to 1 of the following symbols: , , , or .



### TYPE OF FEATURES

Free Game + LP

### REEL CONFIGURATION

5-Reel 3-4-4-4-3-Row Video Slot

### PAYLINES

32 Lines

### DENOMINATIONS

**SA** R0.10

**EU** €0.01

### BET CONFIGURATIONS

1, 2, 3, 4, 5, 6, 7, 8, 9, 10

### MAX BET

Up to 680

(Depends on the above Bet Configurations)

### FREE GAMES

3 or more scattered trigger the free games. During the free games, each awards 1, 2 or 3 additional free games.



### PRIZE REEL

There is a chance PRIZE REEL may be triggered when / / appear during any bought game or free game.

When the PRIZE REEL is triggered, a large PRIZE REEL is displayed on the game screen and spun once only. If the PRIZE REEL indicates only a jackpot win, the jackpot is won and there is a chance that the PRIZE REEL may spin again.





Happy blessings come from wild surprises. During bought games, multiple symbol kinds on all reels may randomly become wild symbols. During bought games and free games, line wins may be multiplied by randomly appearing multiplier wild symbols. When wild symbols appear, there is a chance to trigger a special prize reel that awards jackpots, free games or both. Multiple jackpots may be won on the special prize reel.

### RANDOM FEATURES

#### RANDOM WILD

RANDOM WILD randomly occurs during bought games and free games. All / substituting in a line win multiply the pay for that line only.

#### WILD CHANGE

WILD CHANGE randomly occurs during bought games only.

In the game that WILD CHANGE occurs, 3 or more of the symbol kinds / / / / on all reels randomly change to .



### FREE GAMES

Free games consist of 8 free games. During free games, 3 or more scattered award 5 additional free games.



### PRIZE REEL

There is a chance PRIZE REEL may be triggered when / / appear during any bought game or free game.

When the PRIZE REEL is triggered, a large PRIZE REEL is displayed on the game screen and spun once only. If the PRIZE REEL indicates only a jackpot win, the jackpot is won and there is a chance that the PRIZE REEL may spin again.



*Speed*



### TYPE OF FEATURES

Free Game + LP

### REEL CONFIGURATION

5-Reel 3-4-4-4-3-Row Video Slot

### PAYLINES

32 Lines

### DENOMINATIONS

SA R0.10

EU €0.01

### BET CONFIGURATIONS

1, 2, 3, 4, 5, 6, 7, 8, 9, 10

### MAX BET

Up to 680

(Depends on the above Bet Configurations)

# FU LAI CAI LAI 福来财来

5 SEA  
LEGENDS™

TRIPLE  
FESTIVAL™

STACK WILD  
LUXURY™



ARUZE GAMING

ARUZE GAMING

ARUZE GAMING

Experience an enriching variety of gameplay and surprising riches. Increasing the bet level and credit per play improve several elements of gameplay.

#### TYPE OF FEATURES

Free Game + LP

#### REEL CONFIGURATION

5-Reel 3-Row Video Slot

#### PAYLINES

243 Ways

#### DENOMINATIONS

SA R0.10

EU €0.01

#### BET CONFIGURATIONS

1, 2, 3, 6, 10

#### MAX BET

880

#### FU LAI CAI LAI TRIPLE FESTIVAL

appearing on 3 or more consecutive reels beginning with the leftmost reel trigger the FREE GAMES FEATURE with 8 FREE GAMES. During FREE GAMES FEATURE, reels contains Picture symbols only.

FREE GAMES FEATURE can be triggered again during the FREE GAMES FEATURE.

If the FREE GAMES FEATURE is triggered in the same game as the JACKPOT FEATURE, the FREE GAMES FEATURE starts after the JACKPOT FEATURE ends.

#### FU LAI CAI LAI 5 SEA LEGENDS

appearing on 3 or more consecutive reels beginning with the leftmost reel trigger the FREE GAMES FEATURE with 6 FREE GAMES.

Before FREE GAMES start, select 1 of the symbols from the available options.

If the FREE GAMES FEATURE was triggered when playing bet level 2 or higher, the reels used during the FREE GAMES are composed with the following symbols only: the symbol selected from the available options,

and .

If the FREE GAMES FEATURE was triggered when playing bet level 1, the reels used during the FREE GAMES are composed with the following symbols only: the symbol selected from the available options, , , , , , and .

During the FREE GAMES, appearing on 3 or more consecutive reels beginning with the leftmost reel award an additional 6 FREE GAMES, however the selection of the symbol option is not made again.

If the FREE GAMES FEATURE is triggered in the same game as the JACKPOT FEATURE, the FREE GAMES FEATURE starts after the JACKPOT FEATURE ends.

#### FU LAI CAI LAI STACK WILD LUXURY

appearing on 3 or more consecutive reels beginning with the leftmost reel trigger the FREE GAMES FEATURE with 8 FREE GAMES.

During the FREE GAMES, all symbols on 1 or more reels (reels 2, 3, 4 and 5 according to bet level played) may randomly become .

FREE GAMES FEATURE cannot be triggered again during the FREE GAMES FEATURE.

If the FREE GAMES FEATURE is triggered in the same game as the JACKPOT FEATURE, the FREE GAMES FEATURE starts after the JACKPOT FEATURE ends.



#### JACKPOT FEATURE

The JACKPOT FEATURE can be triggered when playing bet level 2, 3, 4 or 5 only. There is a chance the JACKPOT FEATURE may be triggered when appears.

Alternatively, the JACKPOT FEATURE is triggered when the large drops down to be displayed on the game screen randomly in bought games and free games.

According to the bet level played, up to 4 jackpot levels may be available. In the JACKPOT FEATURE, select from 15 ingots until 3 matching symbols corresponding to a jackpot level are revealed.

If 3 are revealed, an additional JACKPOT FEATURE is awarded and the feature continues until a jackpot level is won.

When 3 matching jackpot level symbols have been revealed, the corresponding jackpot level is won and the JACKPOT FEATURE ends. Any additional JACKPOT FEATURE awarded, starts after the preceding JACKPOT FEATURE ends.

#### WILD COIN BONUS

There is a chance the WILD COIN BONUS may occur when 1 or more appear on the reels in a bought game or free game. When the WILD COIN BONUS occurs, a special credit prize displayed on the game screen is awarded. Special Credit Prize: total credits bet multiplied by either 10, 20, 30, 50 or 100 randomly as displayed.

# FORTUNE DRUMS™







Spinning riches stir up excitement. Picture symbols are increased on reels according to the credits bet played. Special reels comprised exclusively of Picture, "Feature" and "Wild" symbols are used during the 10 Free Games. In DON DON DON, a big win awaits as either a bonus credit prize or 1 of 4 progressive levels is won.

**TYPE OF FEATURES**

Video Wheel / Free Game + LP

**REEL CONFIGURATION**

5-Reel 3-Row Video Slot

**PAYLINES**

243 Ways

**DENOMINATIONS**

**SA** R0.10

**EU** €0.01

**BET CONFIGURATIONS**

- 1, 2, 3, 4, 5
- 1, 2, 3, 5, 10
- 1, 2, 5, 10, 15
- 1, 2, 5, 10, 20

**MAX BET**

440, 880, 1320, 1760

**FREE GAMES**



**DON DON DON**



Spinning riches stir up excitement. Picture symbols are increased on reels according to the credits bet played. When the feature is triggered a Mini Game occurs, improving the reels used during 6 Free Games. In DON DON DON, a big win awaits as either a bonus credit prize or 1 of 4 progressive levels is won.

**TYPE OF FEATURES**

Video Wheel / Free Game + LP

**REEL CONFIGURATION**

5-Reel 3-Row Video Slot

**PAYLINES**

243 Ways

**DENOMINATIONS**

**SA** R0.10

**EU** €0.01

**BET CONFIGURATIONS**

- 1, 2, 3, 4, 5
- 1, 2, 3, 5, 10
- 1, 2, 5, 10, 15
- 1, 2, 5, 10, 20

**MAX BET**

440, 880, 1320, 1760

**FREE GAMES**



**DON DON DON**





Spinning riches stir up excitement. Picture symbols are increased on reels according to the credits bet played. 3  symbols held on reel 3 are used during 10 Free Games. In DON DON DON, a big win awaits as either a bonus credit prize or 1 of 4 progressive levels is won.

### FREE GAMES



### DON DON DON



### TYPE OF FEATURES

Video Wheel / Free Game + LP

### REEL CONFIGURATION

5-Reel 3-Row Video Slot

### PAYLINES

243 Ways

### DENOMINATIONS

**SA** R0.10

**EU** €0.01

### BET CONFIGURATIONS

1, 2, 3, 4, 5

1, 2, 3, 5, 10

1, 2, 5, 10, 15

1, 2, 5, 10, 20

### MAX BET

440, 880, 1320, 1760



Spinning riches stir up excitement. Picture symbols are increased on reels according to the credits bet played. Special reels with consecutive wild symbols and no Royal symbols are used during the 8 Free Games. In DON DON DON, a big win awaits as either a bonus credit prize or 1 of 4 progressive levels is won.

### ZODIAC FEATURE



### DON DON DON



### TYPE OF FEATURES

Video Wheel / Free Game + LP

### REEL CONFIGURATION

5-Reel 3-Row Video Slot

### PAYLINES

243 Ways

### DENOMINATIONS

**SA** R0.10

**EU** €0.01

### BET CONFIGURATIONS

1, 2, 3, 4, 5

1, 2, 3, 5, 10

1, 2, 5, 10, 15

1, 2, 5, 10, 20

### MAX BET

440, 880, 1320, 1760

# COIN COLLECTOR™



5 GUARDIANS

# COIN COLLECTOR™



AUSSIE5



# Speed

## COIN COLLECTOR

Amass golden riches and rack up lots of free games. The number of free games awarded is determined by a number drawing conducted on each triggering feature symbol. Transforming symbols in bought games and free games all become the same symbol. Special scatters can trigger a collect feature in which all prizes displayed on the collected scatters are won, including bonuses and jackpots. Additionally, jackpots can be won randomly during bought games.

### TYPE OF FEATURES

Free Game + LP

### REEL CONFIGURATION

5-Reel 4-Row Video Slot

### PAYLINES

50 Lines

25 Lines

4 Lines (Denomination 4, 5, 6 only)

### DENOMINATIONS

SA					
1	2	3	4	5	6
R0.01	R0.02	R0.05	R0.10	R1	R2
R0.05	R0.10	R0.25	R0.50	R5	R10
R0.10	R0.20	R0.50	R1	R10	R20
R0.50	R1	R2.50	R5	R50	R100
R0.02	R0.05	R0.10	R0.20	R2	R5
R0.20	R0.50	R1	R2	R20	R50
R0.01	R0.02	R0.05	R0.10		
R0.10	R0.20	R0.50	R1		
R0.50	R1	R2.50	R5		
R1	R2	R5	R10		
R5	R10	R25	R50		
R10	R20	R50	R100		
R0.01	R0.05	R0.10	R0.20		
R0.20	R0.50	R1	R2		

EU					
1	2	3	4	5	6
€0.01	€0.02	€0.05	€0.10	€1	€2
€0.05	€0.10	€0.25	€0.50	€5	€10
€0.10	€0.20	€0.50	€1	€10	€20
€0.50	€1	€2.50	€5	€50	€100
€0.02	€0.05	€0.10	€0.20	€2	€5
€0.20	€0.50	€1	€2	€20	€50
€0.01	€0.02	€0.05	€0.10		
€0.10	€0.20	€0.50	€1		
€0.50	€1	€2.50	€5		
€1	€2	€5	€10		
€5	€10	€25	€50		
€10	€20	€50	€100		
€0.01	€0.05	€0.10	€0.20		
€0.20	€0.50	€1	€2		

### BET CONFIGURATIONS

1, 2, 3, 4, 5

1, 2, 3, 5, 10

### MIN/MAX BET

250, 500

125, 250

20, 40 (Denomination 4, 5, 6 only)

### 5 GUARDIANS / AUSSIE 5 FEATURE

appearing on 3 or more consecutive reels beginning with the leftmost reel trigger 5 GUARDIANS / AUSSIE 5 FEATURE.

When the GUARDIANS / AUSSIE 5 FEATURE is triggered, a number appears on each that was involved in triggering the feature.

The sum of the numbers that appeared is awarded as free games in the GUARDIANS / AUSSIE 5 FEATURE.



### MYSTERY SYMBOL

#### COIN COLLECTOR 5 GUARDIANS

appearing on the reels changes to after all reels finish spinning. All appearing in the same game randomly change to the same symbol.

#### COIN COLLECTOR AUSSIE 5

appearing on the reels changes to after all reels finish spinning. All appearing in the same game randomly change to the same symbol.



### DREAM COLLECTOR

Any 6 or more scattered in a bought game or free game trigger DREAM COLLECTOR and are held for the duration of DREAM COLLECTOR. When DREAM COLLECTOR is triggered, 3 free spins are awarded.

Each newly appearing in DREAM COLLECTOR resets the number of remaining free spins to 3.

DREAM COLLECTOR ends after all awarded free spins have been played or if appears in all 20 symbol positions. GRAND JACKPOT is won if appears in all 20 symbol positions. prizes are added to the GRAND JACKPOT win.



### JACKPOT SURPRISE

JACKPOT SURPRISE randomly occurs in bought games only.

When the JACKPOT SURPRISE occurs, 1 of the following prizes is randomly awarded:

- MAJOR JACKPOT
- GRAND JACKPOT
- BONUS



# SUNLIGHT™ SAVANNA 5

# SUNLIGHT™ JOYFUL LION





# SUNLIGHT

HYPER SYMBOL wins multiplied by total number of all matching symbols on the same reels. Rather than lines or ways, standard wins are based on the number of left-to-right reels with matching HYPER SYMBOL that are then multiplied by the total number of all matching HYPER SYMBOL on those winning reels.

## TYPE OF FEATURES

Free Game + LP

## REEL CONFIGURATION

5-Reel 3-Row Video Slot

## PAYLINES

Hyper Symbols

## DENOMINATIONS

SA R0.10

EU €0.01

## BET CONFIGURATIONS

1, 2, 3, 4, 5

1, 2, 3, 5, 10

1, 2, 5, 10, 20

## MAX BET

250, 500, 1000

## FREE GAMES FEATURE

### SUNLIGHT SAVANNA 5



Any 6 or more  trigger the FREE GAMES FEATURE with an initial 5 free games and an initial x4 special multiplier that multiplies the HYPER SYMBOL MULTIPLIER.

Before the FREE GAMES FEATURE starts, each triggering  reveals 1 of the following:

**+1** : Each +1 revealed awards 1 additional free game.

**x1** : Each x1 revealed increases the special multiplier applied during all free games by 1.

During the FREE GAMES FEATURE, any 6 or more  each reveal +1 awarding a total number of additional free games equal to the number of appearing  only.



FREE GAMES FEATURE starts after the JACKPOT FEATURE ends if triggered in the same game.

If the JACKPOT FEATURE is triggered during the FREE GAMES FEATURE, any remaining free games resume after the JACKPOT FEATURE ends.

### SUNLIGHT JOYFUL LION



Any 6 or more  trigger the FREE GAMES FEATURE with 10 free games.

Reels used during the FREE GAMES FEATURE contain an additional 30 , 60  or 120  randomly.

During the FREE GAMES FEATURE, any 6 or more  award 10 additional free games.



FREE GAMES FEATURE starts after the JACKPOT FEATURE ends if triggered in the same game.

If the JACKPOT FEATURE is triggered during the FREE GAMES FEATURE, any remaining free games resume after the JACKPOT FEATURE ends.

## JACKPOT FEATURE



Any combination of SUN SYMBOLS appearing on 3 or more consecutive reels beginning with the leftmost reel trigger the JACKPOT FEATURE.

In the JACKPOT FEATURE, the triggering SUN SYMBOLS are shuffled and then each is hidden behind a . SUN SYMBOL prizes are revealed after the  is selected in the JACKPOT FEATURE.

Select 1  only to reveal the SUN SYMBOL and corresponding prize won for the JACKPOT FEATURE.

JACKPOT FEATURE win is added to any HYPER SYMBOL wins from the triggering game.

# Jack's HAUNTED WINS

# Jack's WINNING SPELL





In addition to free games, there is a chance to trigger a wide variety of unique features whenever wild symbols appear. Enjoy special prize reels, scattered wild, cascading wild, merging reels, a bonus collect feature and a special multiplier reel that increases all bonus wins and also awards jackpots.

### TYPE OF FEATURES

Free Game + LP

### REEL CONFIGURATION

5-Reel 3-4-4-4-3-Row Video Slot

### PAYLINES

40 Lines

### DENOMINATIONS

**SA** R0.10

**EU** €0.01

### BET CONFIGURATIONS

1, 2, 3, 4, 5, 6, 7, 8, 9, 10

### MAX BET

Up to 600

(Depends on the above Bet Configurations)

### MEGA SYMBOL

After all wins are determined in the game that MEGA SYMBOL is awarded, reels 2, 3 and 4 merge to form one large center reel for 1 free spin only.

In the free spin, reels 1 and 5 are held and only the large center reel is spun.

### PRIZE REEL

In PRIZE REEL, select 1 of 3 TOMBSTONE to reveal the number of prize reel spins awarded: 1 SPIN, 2 SPINS or 3 SPINS.

After the number of awarded prize reel spins has been revealed, a large pumpkin containing the prize reel appears on the game screen.

### WILD REEL SPIN

After all wins are determined in the game that WILD REEL SPIN is awarded, overlaying WILD symbol cascade down all reels and may appear in any symbol position.

After the overlaying WILD symbol have cascaded down the reels, all wins are determined one more time.

### RANDOM WILD

After all wins are determined in the game that RANDOM WILD is awarded, extra WILD symbol appears in 4 to 10 random symbol positions.

After the extra WILD symbol have appeared in random symbol positions, all wins are determined one more time.

### HOLD SPIN BONUS

HOLD SPIN BONUS consists of 3 free spins.

Each new BONUS symbol that appears during HOLD SPIN BONUS resets the number of remaining free spins to 3 and is held in position until HOLD SPIN BONUS ends.

After the credit prize or special credit prize is awarded, a MULTIPLIER REEL on the top screen is spun once only.

### JACK'S HAUNTED WINS

#### FREE GAMES



Free games consists of a mini game and 8 free games.

In the mini game, select 1 of 5 to reveal the number of extra added to the free games reels.

### JACK'S WINNING SPELL

#### FREE GAMES



Free games consists of 7 free games.

In each free game during the free games, from 1 to 2 randomly selected reels change to .



# Speed

## LIMITED PAYOUT MACHINES

Gambling machines with a restricted bet and prize.





Bigger wins award more wins. Depending on the bet amount, wins for some symbol combinations award slot games. In addition to any slot games awarded from a scatter win combination, each winning scatter awards a number of slot games via a number drawing. In each slot game, three special reels with numbers representing the ones', tens' and hundreds' digits of the winning prize amount are spun.



### SLOT GAMES (SG)

SLOT GAMES are triggered as described below.

When 3 or more scattered  appear, each  triggers 2, 3, 5, 7, 8, 10, 12, 20, 25, 30 or 50 SLOT GAMES as displayed on the symbol.

The number of SLOT GAMES (SG) listed on the paytable is triggered when the corresponding winning symbol combination appears.

### TYPE OF FEATURES

Slot Game

### REEL CONFIGURATION

5-Reel 3-Row Video Slot

### PAYLINES

10 Lines

### DENOMINATIONS

R1

### BET CONFIGURATIONS

1, 2, 3, 4, 5

### MAX BET

R5



In each SLOT GAME, 3 special reels on the top screen are spun.

The numbers that appear on the reels form the numerical value of the prize won shown in R.

The prize available in each SLOT GAME ranges from R1.00 to R499.00.



Bigger wins award more wins and symbols become one of a kind. Depending on the bet amount, wins for some symbol combinations award slot games. In each slot game, three special reels with numbers representing the ones', tens' and hundreds' digits of the winning prize amount are spun. In the penny games awarded, all Egyptian-themed symbols except scatter become the same symbol on the reels increasing the chances of wins.



### SLOT GAMES (SG)

The number of SLOT GAMES (SG) listed on the paytable is triggered when the corresponding winning symbol combination appears.

In each SLOT GAME, 3 special reels on the top screen are spun.

The numbers that appear on the reels form the numerical value of the prize won shown in R.

The prize available in each SLOT GAME ranges from R1.00 to R499.00.



### PENNY GAMES

3 or more scattered trigger 8 PENNY GAMES.

At the start of each PENNY GAME, all and on the reels become the same symbol.

Each PENNY GAME costs R0.01 to play.



### TYPE OF FEATURES

Penny Game / Slot Game

### REEL CONFIGURATION

5-Reel 3-Row Video Slot

### PAYLINES

10 Lines

### DENOMINATIONS

R1

### BET CONFIGURATIONS

1, 2, 3, 4, 5

### MAX BET

R5



Lucky wins trigger many more wins. A number of action games are triggered in addition to the pays won for certain winning combinations. In each action game, a wheel is spun and a credit prize may be awarded. When penny games are triggered, a special symbol is determined. If the special symbol appears on a reel in a penny game, wins are determined twice: once before the special symbol fills all positions on the reel and once again after.

## TYPE OF FEATURES

Penny Game / Action Game

## REEL CONFIGURATION

5-Reel 3-Row Video Slot

## PAYLINES

5 Lines

## DENOMINATIONS

R1

## BET CONFIGURATIONS



1, 2, 3, 4, 5

## MAX BET

R5



## PENNY GAME

Any 3 or more  trigger 10 PENNY GAMES. The symbol kind that  overlaid in the triggering game is designated as a "FILL" symbol for the determination of secondary wins during PENNY GAMES. After wins are determined for the reel spin in each PENNY GAME, all symbol positions on any reel with an appearing FILL symbol become that FILL symbol and wins are determined one more time for FILL symbols only. When determining the secondary wins for the FILL symbol, the FILL symbol wins do not need to be on adjacent reels. All symbols on reels that do not contain the FILL symbol are invalid in determining secondary wins in a PENNY GAME. During the PENNY GAMES, any 3 or more  award 10 additional penny games. Each PENNY GAME costs R0.01 to play.



## ACTION GAMES

The number of ACTION GAMES (AG) listed on the paytable is triggered when the corresponding winning symbol combination appears. The reels are not used during ACTION GAMES. In each ACTION GAME, the wheel on the top screen is spun. Each ACTION GAME results in either a R10 win, 6 additional ACTION GAMES (AG) awarded or no win (). Each ACTION GAME costs R0.01 to play.



Lucky wins trigger many more wins. A number of action games are triggered in addition to the pays won for certain winning combinations. In each action game, a wheel is spun and a credit prize may be awarded. When penny games are triggered, a special symbol is determined. If the special symbol appears on a reel in a penny game, wins are determined twice: once before the special symbol fills all positions on the reel and once again after.



### PENNY GAME

Any 3 or more trigger 8 PENNY GAMES. The symbol kind that overlaid in the triggering game is designated as a "FILL" symbol for the determination of secondary wins during PENNY GAMES. After wins are determined for the reel spin in each PENNY GAME, all symbol positions on any reel with an appearing FILL symbol become that FILL symbol and wins are determined one more time for FILL symbols only.

When determining the secondary wins for the FILL symbol, the FILL symbol wins do not need to be on adjacent reels. All symbols on reels that do not contain the FILL symbol are invalid in determining secondary wins in a PENNY GAME. During the PENNY GAMES, any 3 or more award 8 additional penny games. If ACTION GAMES and PENNY GAMES are triggered in the same game, PENNY GAMES start after ACTION GAMES end. If ACTION GAMES are triggered during PENNY GAMES, any remaining PENNY GAMES resume after ACTION GAMES end.



### ACTION GAMES

The number of ACTION GAMES (AG) listed on the payable is triggered when the corresponding winning symbol combination appears. The reels are not used during ACTION GAMES. In each ACTION GAME, the wheel on the top screen is spun.

Each ACTION GAME results in 1 of the following:

- R2, R5, R8, R10 or R12 multiplied by R bet as displayed is won.
- 6 AG: awards 6 additional ACTION GAMES (AG).
- : no win

Each ACTION GAME costs R0.01 to play.



### TYPE OF FEATURES

Penny Game / Action Game

### REEL CONFIGURATION

5-Reel 3-Row Video Slot

### PAYLINES

5 Lines

### DENOMINATIONS

R1

### BET CONFIGURATIONS

1, 2, 3, 4, 5

### MAX BET

R5

## CLASS II SYSTEM OVERVIEW

Jogo Bingo Core 2 is a Class 2 solution with a complete EGM platform + Bingo Server solution + Game Runtime for quick land-based game porting of Class 3 games to the tribal Class 2 market.

Providing mathematical tools for Class 3 to Class 2 math model conversion and a rapid game development framework, JBC2 class 2 solution uncomplicates and speeds up the time to market of Class 2 variants of Class 3 game libraries.

### FEATURES & BENEFITS

- Excellent Player Retention
- Performance Tested Solutions
- Easy Integration to Loyalty Programs
- Stand Out Play Synergy Slot Content in Class 2
- Legal and Regulated – compliant and certified game content
- Jackpots and Bonuses – engaging and compelling game content
- Expanded Game Library – no restrictions on what can be achieved
- Compared to other Class game content,  
**Class 2 usually operates with lower costs for casinos**

### GAMES AVAILABLE ON THE CLASS II SYSTEM

- Super Sun Mayan Heat
- Super Sun Savannah Heat





The Golden Frog Baccarat is a commission free version\* of baccarat where a three-card Banker win with a total of 7 results in a Banker push. The Player and Tie bets pay the same as standard baccarat. Our SMRT SHOE and SMRT BOARD allows casinos to eliminate dealer errors and needless keypad entries, while providing valuable gaming data for analytics and game protection.

In addition to the base game, there are five more betting options:

- Koi 8: A wager that the Player hand will win with a three-card total of 8 pays 25 to 1
- Jin Chan 7: A wager that the Banker hand will win with a three-card total of 7 pays 40 to 1
- Three-Card 9 wins against a Three-Card 1 pays 150 to 1\*\*
- Two-Card 9 wins against a Two-Card 7 pays 50 to 1\*\*
- Any 8 wins against any 6 pays 25 to 1\*\*

\* Can be played on Traditional Baccarat

\*\* The hand values are interchangeable between the Player and Banker hands



# EMPIRE<sup>®</sup> Multiplier BLACKJACK



## MAKE EMPIRE MULTIPLIER BLACKJACK<sup>®</sup>/BLACKJACK WAGER

Player makes EITHER OR BOTH the Empire Multiplier Blackjack<sup>®</sup> Wager and/or the Blackjack Wager in any amounts within the table limits. Player receives two cards as the initial Blackjack Hand and Dealer two card, one face down and one face up. Player evaluates his Blackjack Hand.

All Other Player wins in Empire Multiplier Blackjack<sup>®</sup>/Blackjack pay Even Money. Blackjack wins pay per House Rules.

## PLAY & PROCEDURES

Game is dealt and played as traditional Blackjack with the above special provision and Pay Table. All standard Blackjack House Rules apply, including those for splitting hands and doubling down. Dealer hit soft 17.

**Empire Multiplier Blackjack<sup>®</sup>**  
Up to two Wager on the same Blackjack Hand

## ODDS PAID UP TO 4X IN PLAY OF THE GAME

When Player wins on a Dealer bust, Dealer pays up to 4X all winning Empire Multiplier Blackjack<sup>®</sup> Wager still in action per the following Pay Table:

PAYTABLE	
BUST WITH 6	4:1
BUST WITH 7	3:1
BUST WITH 8	3:2
BUST WITH 9	3:2
BUST WITH J, Q, or K	1:2
BUST WITH NATURAL 10	PUSH
ANY OTHER WIN	1:1
BLACKJACK	3:2



**"STEP IT UP" BLACKJACK**

DEALER MUST HIT A SOFT 17  
**PAYS 2 to 1**  
 BLACKJACK PAYS 3 to 2  
**INSURANCE PAYS 2 to 1**

**DEALER TOTAL**

Dealer Total	Pays
17 / 18	2 to 1
19 / 20	2 to 1
21 / 22	3 to 1
23 / 24	6 to 1
25 / 26	9 to 1

**DEALER TOTAL**

Dealer Total	Pays
17 / 18	2 to 1
19 / 20	2 to 1
21 / 22	3 to 1
23 / 24	6 to 1
25 / 26	9 to 1

**DEALER TOTAL**

Dealer Total	Pays
17 / 18	2 to 1
19 / 20	2 to 1
21 / 22	3 to 1
23 / 24	6 to 1
25 / 26	9 to 1

**DEALER TOTAL**

Dealer Total	Pays
17 / 18	2 to 1
19 / 20	2 to 1
21 / 22	3 to 1
23 / 24	6 to 1
25 / 26	9 to 1



Players want more ways to win and "Step It Up" Blackjack gives them what they want. Blackjack with extra bets on the dealers total – it's easy. Simple to understand and more fun to play!

Traditional Blackjack rules apply and the dealer hits on Soft 17.

Players place the primary wager and may place a "Step it Up" wager on one or more of the side bet locations.

The player wins the "Step it Up" Blackjack side wager if they placed a wager in the betting location that corresponds with the dealer's final card total.

Winning wagers are paid according to the pay table.

Table Game Directors love "Step it Up" Blackjack:

- Simple game with a short learning curve
- No special training required for dealers
- Easy game for Surveillance viewing
- Casinos can offer an exciting new way to play Blackjack with a higher net win per table
- Attractive payable for players, balanced with profitable house edge percentages



**A NEW WAY TO PLAY HOLD'EM SHORTER DECK.  
BETTER HAND!**

**SHORTER DECK (6+)  
HOLD'EM HAND RANKINGS**

- Royal Flush
- Straight Flush (including A-6-7-8-9)
- Four-of-a-Kind
- Flush
- Full House
- Three-of-a-Kind
- Straight (including A-6-7-8-9)
- Two Pair
- One Pair
- High Card



**Hole Cards Bonus Pay Table**

Hand	Pays "to 1"
Black AA vs. Red AA	1000
AA vs. AA	250
AA	15
AK Suited	13
A with Q or J Suited	9
AK Unsuitd	7
A with Q or J Unsuitd	4
Any Pair	2

**6+ Bonus Pay Table**

Hand(s)	Pays "to 1"
Royal Flush	100 to 1
Straight Flush	50 to 1
4 of a Kind	15 to 1
Flush	7 to 1
Full House	4 to 1
3 of a Kind	2 to 1



**MENSA**  
PROGRESSIVE SYSTEM™

## PROGRESSIVE TECHNOLOGY for POKER

The MENSA Poker Progressive System is a game changer for any poker room. Poker is a player favorite and a necessity for operators. The challenge? Increasing profitability. Operators also have the challenge of creating value for players - how to keep them in their poker room versus going to the competition.



With Aruze's MENSA, operators make greater profits and create a competitive advantage poker players love!

### The Table

- A unique table design with configurable LED lighting
- An easy-access, modern table design with a hinged table top
- Player terminals for each player to manage their side bets via the digital player wager account
- Player terminals also support customizable marketing messages
- Customizable LED lighting to indicate different table states

### Operational Advantages

- Maintain game speed and hands per hour by automating the side bet process and minimizing dealer involvement
- Players have a side bet digital player wager account
- Track hands per hour to better understand dealer efficiency
- LED lighting on the table can be customized and used for zoning areas of the room in a poker tournament, highlighting a customer need and location by color code

### The Progressive

- Ability to offer life changing jackpot awards
- Multiple jackpot pay tables and the flexibility to change them to increase variety and value for your players
- A Progressive Jackpot that increases your poker room profits
- Ability to send messaging to signage around the property to market the Jackpot

### Mensa Poker Table Top View



Players screen UI/UX



# Play Aruze's best games online!

For inquiries, contact: [info@aruze-interactive.com](mailto:info@aruze-interactive.com)



Aruze has brought its high performing land-based content online with a library of over 30 games and growing.

Enjoy Free to Play games at your leisure!

Aruze Interactive is a key growth segment for Aruze Gaming.

Aruze has begun development of new and innovative "Digital First" games.

We are targeting the regulated real money gaming markets in North America, Latin America, and Europe.

Aruze content is also available for Social Gaming.

Aruze has been live in NJ for over a year and will be expanding into other regulated states in the US soon.





**ARUZE**  
INTERACTIVE

Whether you are at home  
or on the go, you can always  
locate your favorite  
**Aruze games!**



Zynga – HIT IT RICH



LUCKY NORTH CASINO



BEST BET CASINO



SUPER LUCKY CASINO



TROPWORLD CASINO



GSN – WHEEL OF FORTUNE



MAGICIAN CASINO 2





## Arcade Driving - Fun You Can Bet On!

Get your heart pumping with realistic racing action. Race solo or with friends through speedway, city or mountain tracks, chasing jackpots at breakneck speeds. The faster you go, the more you win!

## Game Features

- Single OR Multi-Player
- 5 race tracks, plus Easy / Med / Hard levels
- Choose from 8 uniquely styled race cars muscle / sports / exotic
- Leaderboard feature - best lap time
- Supported languages: English, Spanish, French, German, Korean, Chinese (Simplified & Traditional)
- Multiple gambling variations
- Skill influenced and chance based versions

### Cabinet Styles

Available on 2600XL cabinet config with realistic steering wheel & foot pedals.

### Certification Specs

- GLI - 11 2.1 and 3.0 Certified
- Class III
- SAS 6.03 compatible





## Wagering

Denomination	R1.00
Wager Rate	Approx. 30 Wagers per minute
Wager Amounts	<ul style="list-style-type: none"> <li>• 10, 20, 30, 40, 50</li> <li>• 20, 40, 60, 80, 100</li> <li>• 40, 80, 120, 160, 200</li> <li>• 50, 100, 150, 200, 250</li> <li>• 60, 120, 180, 240, 300</li> <li>• 80, 160, 240, 320, 400</li> <li>• 100, 200, 300, 400, 500</li> </ul>
Est. RTP Settings (Skill-Influenced)	84.5% - 98%
RTP Settings (Pure Chance-Based)	87.5% - 95%
Volatility Settings	Low-Med
Top Award	250X wager
Max Bonus	Varies based on number of wagers per level

\*Wager Amount, RTP, Top Award and Bonus Multipliers



# INNOVATION REBORN



## **Aruze Gaming Africa PTY LTD.**

P.O. Box 11484, Vorna Valley 1684 Unit 1/2/3 Kyalami Village 57  
Forsman Close, Barbeque Downs Ext. 1  
Kyalami, Midrand, Gauteng, South Africa  
TEL: +27 11-466-3388 FAX: +27 11-466-3389  
EMAIL: sales@aruzegaming.co.za

### **Aruze Gaming Global HQ**

1106 Palms Airport Dr Las Vegas, NV 89119  
TEL: +1 702-781-8080  
EMAIL: info@aruzeglobal.com

### **Customer Technical Support**

Available 24 hours a day / 7 days a week  
TEL: +1 877-438-0569  
EMAIL: service@aruzeglobal.com

### **Aruze Gaming Global Central Office**

10447 Lemoyne Blvd Biloxi, MS 39532  
TEL: +1 702-781-8080

### **Empire Technological Group Japan K.K**

1-2-7, Kandasudacho Awajichouekimae Bldg. 3F.  
Chiyoda-Ku, Tokyo, 101-0041 Japan

### **Empire Shared Services Philippines, Inc.**

Ayala Tower One 1105-1106, 6767 Ayala Avenue  
Corner Paseo de Roxas, Makati, Philippines

### **Empire Technological Group Limited - Macau Branch**

Avenida Xian Xing Hai, No.105, Centro Golden  
Dragon, 11 Andar N, Macau  
TEL: +1 853-2881-2381  
EMAIL: muilee.quah@aruzeglobal.com

### **Aruze Gaming Australia PTY LTD.**

Unit 6, 463 Victoria Street, Wetherill Park,  
NSW 2164, Australia  
TEL: +61 2-8332-6000  
EMAIL: sales@aruzegaming.com.au

## **CONFIDENTIAL**

For Aruze Customer's Internal use only  
Do Not Otherwise Reproduce or Disclose

Follow us @AruzeGaming



www.aruzeglobal.com