



ARUZEGAMING®
GLOBAL

LEGACY REBORN

G2E LAS VEGAS | Product Catalog 2023-2024







CONTENTS

MUSO CURVE-55 HYBRID, MUSO CURVE-43 and MUSO CURVE-43 HYBRID

MUSO CURVE-55 Hybrid (Cabinet Feature)	5
MUSO CURVE-43 (Cabinet Feature)	6
MUSO CURVE-43 Hybrid (Cabinet Feature)	7
X Wheel Supreme Series	8
X Wheel Supreme God	9
X Wheel Supreme Dragon	10
Gong Cash Series	11
Gong Cash Dragon	12
Gong Cash Lion	13
Firestorm Series	14
Firestorm Bull	15
Firestorm Lion	16
Gong Gong Lai Fu Series	17
Gong Gong Lai Fu Caishen Riches	18
Gong Gong Lai Fu Mighty Buddha	19
Fu Lai Cai Lai Fortune Series	20
Fu Lai Cai Lai Fortune 5 Sea Legends	21
Fu Lai Cai Lai Fortune Triple Festival	22
Fu Lai Cai Lai Fortune Stack Wild Luxury	23
God of Winning Series	24
God of Winning Great Hammer	25
God of Winning Super Spear	26
Triple Treasure Pot Series	27
Triple Treasure Pot Heavenly Wealth	28
Triple Treasure Pot Eternal Prosperity	29
Long Fu Zhu Series	30
Long Fu Zhu Mongol Storm	31
Long Fu Zhu Panda Strike	32
Bingo Jackpot Series	33
Bingo Jackpot Las Vegas	34
Bingo Jackpot New York	35

MUSO TRIPLE-32 HYBRID

MUSO TRIPLE-32 Hybrid (Cabinet Feature)	36
Bomb Collector Series	37
Bomb Collector Gold Heist	38
Bomb Collector Treasure Heist	39
Diamond Pays Series	40
Diamond Pays Oriental Princess	41
Diamond Pays Arabian Oasis	42
Fortune Frame Series	43
Fortune Frame Dragon Bounty	44
Fortune Frame Panda Carnival	45
Dancing Panda Supreme Series	46
Dancing Panda Supreme Festival	47
Dancing Panda Supreme Fortune	48
Tomb Treasure Series	49
Tomb Treasure Cleopatra Legend	50
Tomb Treasure Pharaoh Gold	51
Tomb Treasure Sphinx Gold	52

HYPER SPEED

HYPER SPEED (Cabinet Feature)	53
Fu Jin Shu Series	54
Fu Jin Shu Dragon	55
Fu Jin Shu Phoenix	56
Cai Yun Lai Series	57
Cai Yun Lai Dragon	58
Cai Yun Lai Lion	59
Cai Yun Lai Panda	60
Fu Ru Yi Series	61
Fu Ru Yi Phoenix	62
Fu Ru Yi Kirin	63
Thor and Odin	64
Thor	65
Odin	66

SPEED

SPEED (Cabinet Feature)	68
Poker Slot Blitz	69
Orb of Wealth Series	70
Orb of Wealth Mythic Beasts	71
Orb of Wealth Shining Fortune	72
Bound For Riches Series	73
Bound For Riches Aztec Legend	74
Bound For Riches Chinese Celebration	74
Bound For Riches Egyptian Majesty	75
Bound For Riches Spanish Matador	75
Golden \$20's	76
Lucky Luau 7s	77
Co Co Coin Series	78
Co Co Coin Egyptian Treasure	79
Co Co Coin Pirates Treasure	80
Dancing Panda Series	81
Dancing Panda Fortune	82
Dancing Panda Festival	83
Fu Lai Cai Lai Series	84
Fu Lai Cai Lai 5 Sea Legends	85
Fu Lai Cai Lai Triple Festival	85
Fu Lai Cai Lai Stack Wild Luxury	85
Snow Much Ca\$h	86
Fortune Drums Series	87
Fortune Drums Dragon Boat	88
Fortune Drums Zodiac Beasts	88
Fortune Drums Bag of Wealth	89
Fortune Drums Chinese Luxury	89
Coin Collector Series	90
Coin Collector 5 Guardians	91
Coin Collector Aussie 5	91
Sunlight Series	92
Sunlight Savanna 5	93
Sunlight Joyful Lion	93
Jack's Series	94
Jack's Haunted Wins	95
Jack's Winning Spell	95

MUSO LIMITED

Dragong Lion	96 - 97
Dragong Phoenix	96 - 97
Ji Ji Fu Raging Dragon	98 - 99
Ji Ji Fu Raging Phoenix	98 - 99

ACTIV PLAY

Rock Paper Scissors	100 - 101
---------------------	-----------

BAR TOP GAMES

Multi-Game Bar Suite	102
----------------------	-----

CLASS 2 GAMES

Class 2 System Overview	103
Big Bear Poker	104

TABLE GAMES

Golden Frog Baccarat	105
Empire Multiplier Blackjack	106
Step it up Blackjack	107
Short Deck Vegas 6+ Hold'em	108

iGAMING

iGAMING	109 - 110
---------	-----------



MUSO™
CURVE-55HB

mu·so [mōō - sō] *adj.*
being the only one of its kind;
unlike anything else.



New Face

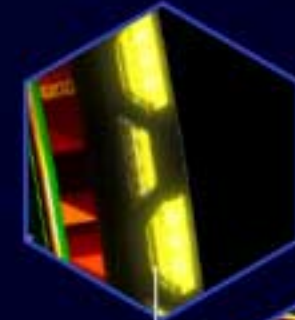

New honeycomb
LED (Details)



New vertical
55-inch
J-Style
curved
LCD monitor

A stunning new
honeycomb cabinet
LED display to
attract players.

Thoughtful touches
to keep them
comfortable.

All designed for an
unparalleled 55-inch
full screen dynamic
gaming experience.

**BUILT FOR
EXCELLENCE**

DIMENSION

Upright Height (Tower Light Included)
108.3 in (2756.9 mm)

Upright Height (Tower Light Excluded)
104.4 in (2652.5 mm)

Width
31.9 in (810 mm)

Depth
33 in (838.2 mm)

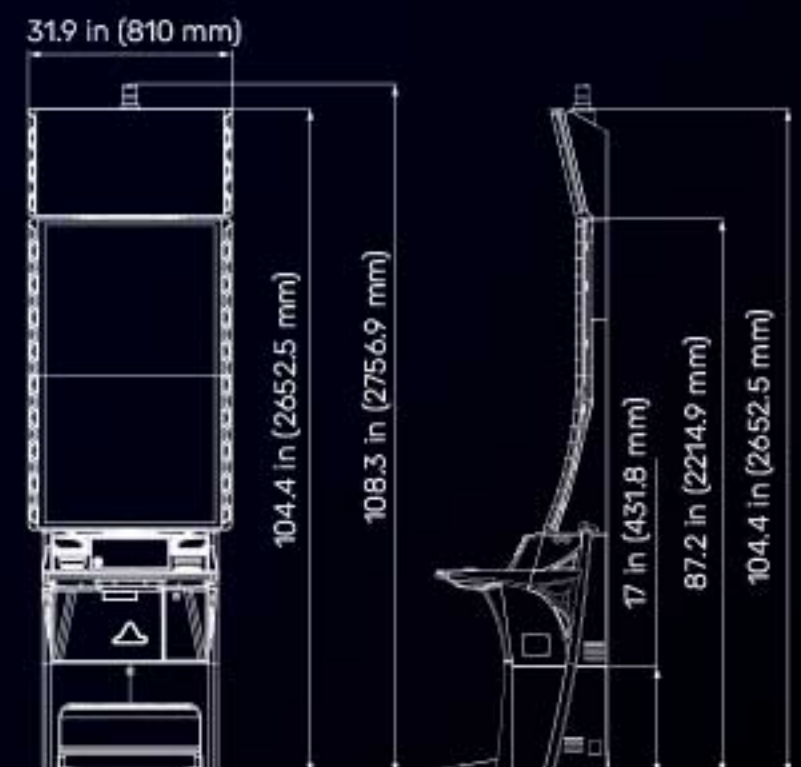
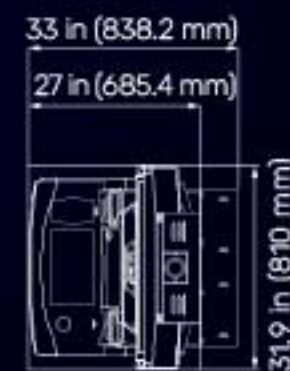

A stunning lighting display to attract players.
Thoughtful touches to keep them comfortable.
All designed for an unparalleled gaming experience.

Distinctive LED Ambience

Unique visual experience not replicated in the market, Muso Curve-43 creates a stunning light display with its never before seen 360-degree LED backlighting.

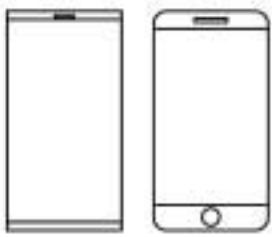

USB charging

USB charging port & panel also provided for player convenience.



Amp up the gaming experience

Newly designed sound system creates powerful theater-like sound.

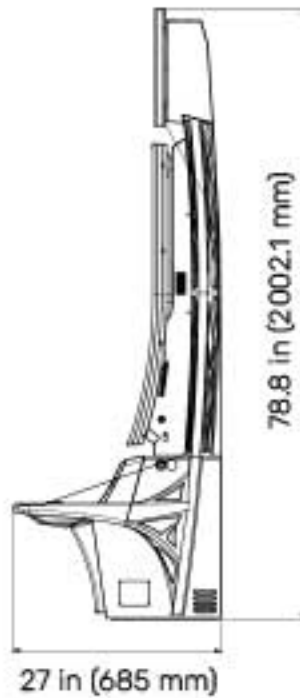
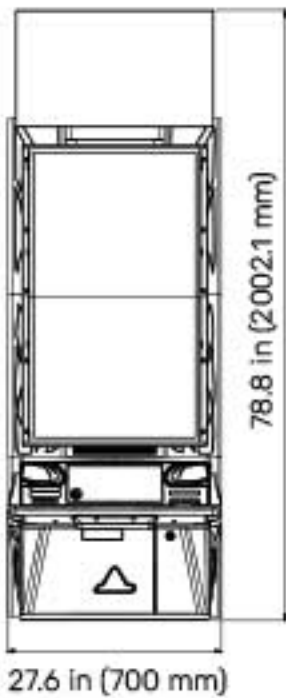
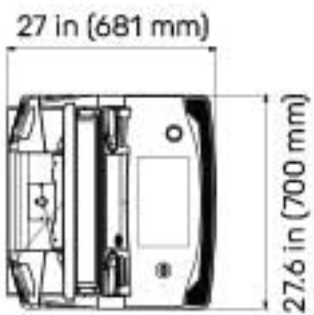

Stunning HD Graphics

An LCD monitor with a 27-inch LCD monitor topper. Breathtaking images on a vertical 43-inch J-style curved.

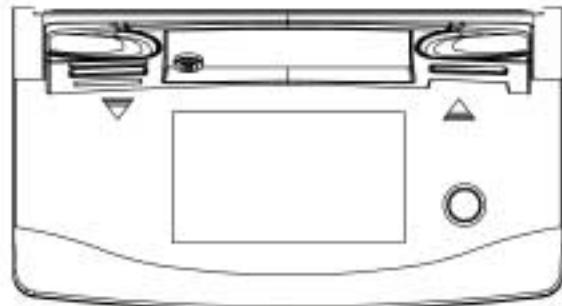

Ergonomic button deck

Inviting wrist rest and expansive glass table. Completely new interface design displayed on a 338-mm (13.3-inch) LCD deck.

DIMENSION

Height

78.8 in (2002.1 mm)*

Width

27.6 in (700 mm)

Depth

27 in (685 mm)

**Height of the tower light not included.*



MUSO™
CURVE-43

mu•so [mōō - sō] adj.

being the only one of its kind;
unlike anything else.



BUILT FOR EXCELLENCE



MUSO™ CURVE-43HB

mu·so [mōō - sō] *adj.*

being the only one of its kind;
unlike anything else.

Distinctive LED Ambience

Unique visual experience not replicated in the market, Muso Curve-43 HB creates a stunning light display with its never before seen 360-degree LED backlighting.

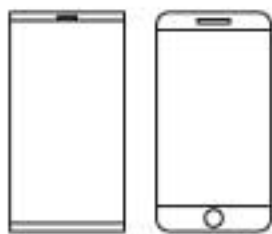

USB charging

USB charging port & panel also provided for player convenience.



Amp up the gaming experience

Newly designed sound system creates powerful theater-like sound.

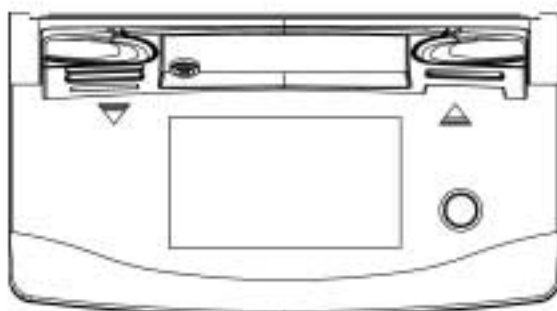

Ergonomic button deck

Inviting wrist rest and expansive glass table. Completely new interface design displayed on a 338-mm (13.3-inch) LCD deck.

A stunning lighting display to attract players.

Thoughtful touches to keep them comfortable.

All designed for an unparalleled 43-inch full screen dynamic gaming experience.



Stunning HD Graphics

An LCD monitor with a 27-inch LCD monitor topper. Breathtaking images on a vertical 43-inch J-style curved.

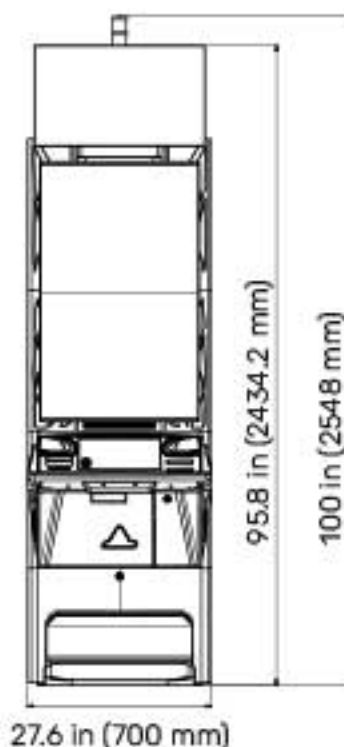
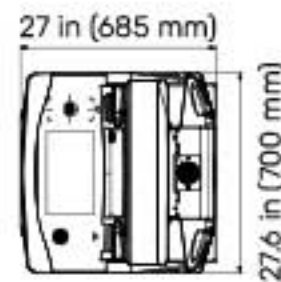

DIMENSION

Upright Height (Tower Light Included)
100 in (2548 mm)

Upright Height (Tower Light Excluded)
95.8 in (2434.2 mm)

Width
27.6 in (700 mm)

Depth
27 in (685 mm)

BUILT FOR EXCELLENCE

X WHEEL SUPREME™ X WHEEL SUPREME™

GOD DRAGON

X WHEEL SUPREME™
GOD

GRAND	\$5,000.01
MAJOR	\$500.02
MINOR	\$25.03
WHEEL	\$10.07

X WHEEL SUPREME™
DRAGON

GRAND	\$5,000.01
MAJOR	\$500.02
MINOR	\$25.04
WHEEL	\$10.08

Wheel of Fortune for X Wheel Supreme God. The wheel features numbers 1-15 and symbols including a lion's head, a crown, and various icons. Below the wheel is a 5x3 grid of symbols including J, K, Q, WILD, and 9.

Wheel of Fortune for X Wheel Supreme Dragon. The wheel features numbers 1-15 and symbols including a dragon's head, a crown, and various icons. Below the wheel is a 5x3 grid of symbols including J, K, Q, WILD, and 9.



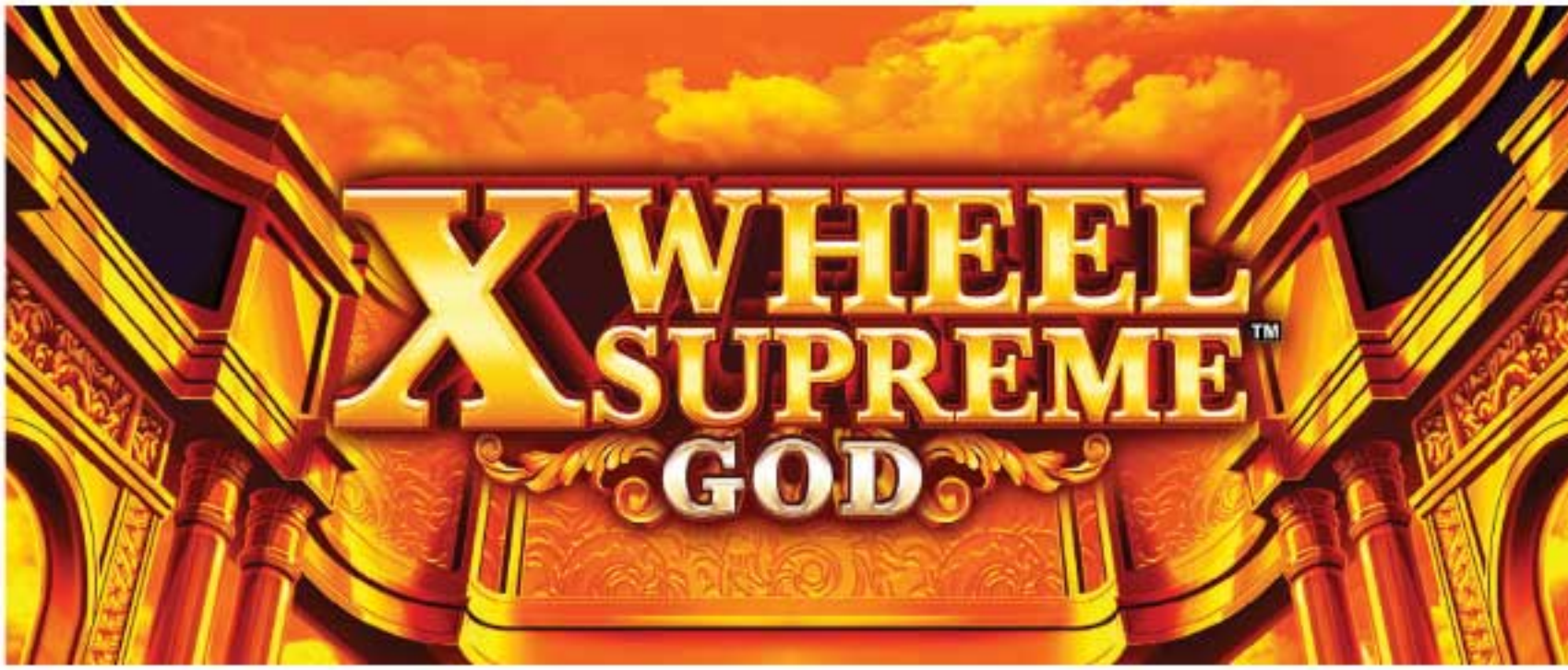

Players have SUPREME fun with extra reel spins and wheel spin multipliers. Scattered bonus symbols trigger a collect feature in which all prizes on collected bonus symbols contribute to a bonus prize total multiplied by a wheel-selected multiplier. Look for special bonus symbols to appear in the collect feature that add additional spins resulting in more chances to increase the bonus prize total. There is also a chance to win a wheel-selected jackpot when wild symbols appear in bought games.

CASH SPIN FEATURE, BONUS PRIZE METER and MULTIPLIER WHEEL

Any 3 or more trigger the CASH SPIN FEATURE. When the CASH SPIN FEATURE is triggered, 3 free spins are awarded. The PRIZE AMOUNT displayed on any appearing in a free spin is added to the BONUS PRIZE meter.



Each appearing in a free spin awards 1 additional free spin.

If 1 or more appeared during a free spin, at the end of the CASH SPIN FEATURE the MULTIPLIER WHEEL is spun once to award a multiplier that is applied to the BONUS PRIZE total which is then won.

During the CASH SPIN FEATURE, the BONUS PRIZE meter is displayed at the center of the MULTIPLIER WHEEL. The MULTIPLIER WHEEL is spun once at the end of the CASH SPIN FEATURE to award a multiplier that applies to the BONUS PRIZE total.

After the MULTIPLIER WHEEL is spun, 1 multiplier is awarded as indicated by the pointer at the top of the wheel. The MULTIPLIER WHEEL contains the following multipliers: 2x, 3x, 4x, 5x, 7x, 8x, 10x, 12x, 15x and 20x.

JACKPOT WHEEL



There is a chance that the JACKPOT WHEEL may be triggered when 1 or more appear.

After the wheel is spun, 1 jackpot is awarded as indicated by the pointer at the top of the wheel.

The JACKPOT WHEEL contains the following:

- 4 JACKPOT LEVELS: GRAND, MAJOR, MINOR and MINI.



TYPE OF FEATURES

Video Wheel / Free Game + LP

REEL CONFIGURATION

5-Reel 3-Row Video Slot

PAYLINES

30 Lines

DENOMINATIONS

1c

BET CONFIGURATIONS

1, 2, 3, 4, 5, 6, 7, 8, 9, 10

MIN/MAX BET



75 Bet up to 750 Bet

(Depends on the above Bet Configurations)



Players have SUPREME fun with extra reel spins and wheel spin multipliers. Scattered bonus symbols trigger a collect feature in which all prizes on collected bonus symbols contribute to a bonus prize total multiplied by a wheel-selected multiplier. Look for special bonus symbols to appear in the collect feature that add additional spins resulting in more chances to increase the bonus prize total. There is also a chance to win a wheel-selected jackpot when wild symbols appear in bought games.

CASH SPIN FEATURE, BONUS PRIZE METER and MULTIPLIER WHEEL

Any 3 or more  trigger the CASH SPIN FEATURE. When the CASH SPIN FEATURE is triggered, 3 free spins are awarded. The PRIZE AMOUNT displayed on any  appearing in a free spin is added to the BONUS PRIZE meter.



Each  appearing in a free spin awards 1 additional free spin.

If 1 or more  appeared during a free spin, at the end of the CASH SPIN FEATURE the MULTIPLIER WHEEL is spun once to award a multiplier that is applied to the BONUS PRIZE total which is then won.

During the CASH SPIN FEATURE, the BONUS PRIZE meter is displayed at the center of the MULTIPLIER WHEEL. The MULTIPLIER WHEEL is spun once at the end of the CASH SPIN FEATURE to award a multiplier that applies to the BONUS PRIZE total.

After the MULTIPLIER WHEEL is spun, 1 multiplier is awarded as indicated by the pointer at the top of the wheel. The MULTIPLIER WHEEL contains the following multipliers: 2x, 3x, 4x, 5x, 7x, 8x, 10x, 12x, 15x and 20x.

JACKPOT WHEEL



There is a chance that the JACKPOT WHEEL may be triggered when 1 or more  appear.

After the wheel is spun, 1 jackpot is awarded as indicated by the pointer at the top of the wheel.

The JACKPOT WHEEL contains the following:

- 4 JACKPOT LEVELS: GRAND, MAJOR, MINOR and MINI.

TYPE OF FEATURES

Video Wheel / Free Game + LP

REEL CONFIGURATION

5-Reel 3-Row Video Slot

PAYLINES

30 Lines

DENOMINATIONS

1c

BET CONFIGURATIONS

1, 2, 3, 4, 5, 6, 7, 8, 9, 10

MIN/MAX BET

75 Bet up to 750 Bet

(Depends on the above Bet Configurations)

GONG CASH™ DRAGON

GONG CASH™ LION

GRAND
\$2,500.01

MAJOR
\$250.01

MINOR **MINI**
\$20.03 \$10.04

GRAND
\$2,500.01

MAJOR
\$250.01

MINOR **MINI**
\$20.03 \$10.05

**GONG CASH™
DRAGON**

1c 912 88 0

**GONG CASH™
LION**

1c 912 88 0





Fortunes abound with overflowing pots of gold coins in this exciting theme. With mystery symbols that randomly change and surprise bonuses, riches may be just one spin away. Special scatters add to the fun and can trigger even more free spins & prizes.

GONG SPIN FEATURE



3 scattered  appearing on reels 2, 3 and 4 trigger the GONG SPIN FEATURE.

Different reels are used during the GONG SPIN FEATURE.

When the GONG SPIN FEATURE is triggered, 3 free spins are awarded.

Each newly appearing  displaying "+1 SPIN" in a free spin awards 1 additional free spin.

GONG SPIN FEATURE ends after all awarded free spins have been played.

Credits bet during the GONG SPIN FEATURE are the same as the game that triggered the GONG SPIN FEATURE.

JACKPOT FEATURE



There is a chance that the JACKPOT FEATURE may be triggered when 1 or more  appears in bought games only. In the JACKPOT FEATURE, select from 12 icons until 3 matching symbols corresponding to a JACKPOT level are revealed.

When 3 matching JACKPOT level symbols have been revealed, the corresponding JACKPOT level is won and the JACKPOT FEATURE ends. The chances of revealing each jackpot symbol are not equal.

A JACKPOT level is reset to its initial value each time that JACKPOT level is won.

JACKPOT FEATURE and GONG SPIN FEATURE cannot be triggered in the same game.

TYPE OF FEATURES

Free Game + LP

REEL CONFIGURATION

5-Reel 3-Row Video Slot

PAYLINES

243 Ways

DENOMINATIONS

1¢

BET CONFIGURATIONS

1, 2, 3, 4, 5, 6, 7, 8, 9, 10

MIN/MAX BET

88 up to 880

(Depends on the above Bet Configurations)



Fortunes abound with overflowing pots of gold coins in this exciting theme. With mystery symbols that randomly change and surprise bonuses, riches may be just one spin away. Special scatters add to the fun and can trigger even more free spins & prizes.

GONG SPIN FEATURE



3 scattered appearing on reels 2, 3 and 4 trigger the GONG SPIN FEATURE.
 Different reels are used during the GONG SPIN FEATURE.
 When the GONG SPIN FEATURE is triggered, 3 free spins are awarded.
 Each newly appearing displaying "+1 SPIN" in a free spin awards 1 additional free spin.
 GONG SPIN FEATURE ends after all awarded free spins have been played.
 Credits bet during the GONG SPIN FEATURE are the same as the game that triggered the GONG SPIN FEATURE.

JACKPOT FEATURE



There is a chance that the JACKPOT FEATURE may be triggered when 1 or more appears in bought games only. In the JACKPOT FEATURE, select from 12 icons until 3 matching symbols corresponding to a JACKPOT level are revealed.
 When 3 matching JACKPOT level symbols have been revealed, the corresponding JACKPOT level is won and the JACKPOT FEATURE ends. The chances of revealing each jackpot symbol are not equal.
 A JACKPOT level is reset to its initial value each time that JACKPOT level is won.
 JACKPOT FEATURE and GONG SPIN FEATURE cannot be triggered in the same game.



TYPE OF FEATURES

Free Game + LP

REEL CONFIGURATION

5-Reel 3-Row Video Slot

PAYLINES

243 Ways

DENOMINATIONS

1c

BET CONFIGURATIONS

1, 2, 3, 4, 5, 6, 7, 8, 9, 10

MIN/MAX BET

88 up to 880
 (Depends on the above Bet Configurations)

FIRESTORM™ BULL

FIRESTORM™ LION





Special fireball symbols award blazing prizes. Transforming symbols in bought games and free games all become the same symbol. The number of free games awarded is the sum of the numbers appearing on each triggering feature symbol. Special scatters can trigger a collect feature in which all prizes displayed on the collected scatters are won, including bonuses and jackpots. Special symbols can unlock additional symbol rows during the collect feature bringing even more blazing wins. Additionally, jackpots can be won randomly during bought games.



FREE GAMES FEATURE

☀ appearing on 3 or more consecutive reels beginning with the leftmost reel trigger the FREE GAMES FEATURE. When the FREE GAMES FEATURE is triggered, a number appears on each ☀ that was involved in triggering the feature. 1, 2, 3, 5, 7 or 10 free games are awarded for each ☀. The sum of the numbers that appeared is awarded as free games in the FREE GAMES FEATURE. FREE GAMES FEATURE can be triggered again during the FREE GAMES FEATURE. FREE GAMES FEATURE starts after RISING FIRE ends if triggered in the same game. If RISING FIRE is triggered during the FREE GAMES FEATURE, any remaining free games resume after RISING FIRE ends.



MYSTERY SYMBOL

☐ appearing on the reels changes to ☀, ☀, ☀, ☀, ☀, ☀, ☀, A, K, Q, J, 10 or 9 after all reels finish spinning. All ☐ appearing in the same game randomly change to the same symbol. If ☐ appears, wins are determined after ☐ finishes changing. Does not appear during RISING FIRE.



RISING FIRE

Any 6 or more ☀ / ☀ in a bought game or free game trigger RISING FIRE. During RISING FIRE, all symbol positions become individual spinning bonus reels. Any ☀ that trigger RISING FIRE or appear during RISING FIRE are held for the duration of RISING FIRE. Any ☀ that trigger RISING FIRE or appear during RISING FIRE decrease the remaining number of ☀ needed to unlock bonus symbol rows and decrease the number of remaining ☀ needed to win the UP UP JACKPOT. When RISING FIRE is triggered, 3 free spins are awarded. Each newly appearing ☀ / ☀ in a free spin resets the number of remaining free spins to 3. RISING FIRE ends after all awarded free spins have been played or if ☀ fills every symbol position. Any unlocked bonus symbol row is locked again after RISING FIRE ends. The number of remaining ☀ required to unlock any bonus symbol row is reset after RISING FIRE ends. The number of remaining ☀ required to win the UP UP JACKPOT is reset after RISING FIRE ends.



JACKPOT SURPRISE RISING FIRE

There is a chance that 1 JACKPOT is randomly won in bought games except when FREE GAMES FEATURE or RISING FIRE is triggered.

TYPE OF FEATURES

Free Game + LP

REEL CONFIGURATION

5-Reel 4-Row Video Slot
(Up to 10 rows during RISING FIRE)

PAYLINES

50 Lines

DENOMINATIONS

1	2	3	4	5
1c	2c	5c	10c	20c
5c	10c	25c	50c	\$1
10c	20c	50c	\$1	\$2
50c	\$1	\$2.50	\$5	\$10
\$1	\$2	\$5	\$10	\$20

BET CONFIGURATIONS

1, 2, 3, 4, 5, 8, 10

MAX BET

75 Bet up to 975 Bet
(Depends on the above Bet Configurations)

GONGGONG LAIFU™

CAISHEN RICHES™

MIGHTY BUDDHA™



GRAND JACKPOT
\$10,000.01

MEGA BONUS \$1,000.00	MAJOR BONUS \$500.00
MINOR BONUS \$100.00	MINI BONUS \$60.00

The reel display shows five reels with various symbols including a golden '福' (Fu) character, a dragon, and other traditional motifs. Below the reels, the game title 'GONGGONG LAIFU' and 'CAISHEN RICHES' are displayed. At the bottom, there are controls for bet size (1c, 2000) and a display showing '500' and '0'.

GRAND JACKPOT
\$10,000.01

MEGA BONUS \$1,000.00	MAJOR BONUS \$500.00
MINOR BONUS \$100.00	MINI BONUS \$60.00

The reel display shows five reels with various symbols including a golden '福' (Fu) character, a dragon, and other traditional motifs. Below the reels, the game title 'GONGGONG LAIFU' and 'MIGHTY BUDDHA' are displayed. At the bottom, there are controls for bet size (1c, 2000) and a display showing '500' and '0'.





The sound of Gong brings good fortune. A new set of reels will appear during Gong Gong Lai Fu Feature, awarding Credits or Bonuses. Each Gong symbol appearing is held for the entire Feature and adds to the prizes shown on the top of the reels. Grand Jackpot can be won when 15 Gong symbol are collected during Gong Gong Lai Fu Feature or as Jackpot Surprise during the bought games.

FREE GAMES FEATURE



Any 3 Gong symbols appearing on reels 2, 3 and 4 trigger the FREE GAMES FEATURE with 8 free games.

Reels used during the free games feature contain a greater total number of Gong symbols.

Free games feature can be triggered again during the free games feature.

Free games feature starts after the GONG GONG LAI FU FEATURE ends if triggered in the same game.

If GONG GONG LAI FU FEATURE is triggered during the free games feature, any remaining free games resume after the GONG GONG LAI FU FEATURE ends.

GONG GONG LAI FU FEATURE



Any 6 or more Gong symbols trigger the GONG GONG LAI FU FEATURE and are held in position on the reels for the duration of the GONG GONG LAI FU FEATURE.

GONG GONG LAI FU FEATURE consists of 3 free spins.

During the GONG GONG LAI FU FEATURE, each symbol position becomes an individual spinning bonus reel.

In the GONG GONG LAI FU FEATURE, a prize map corresponding to the 15 symbol positions on the reels is displayed above the reels. Before the first free spin, each Gong symbol on the reels displays the prize from the corresponding location on the prize map. While a Gong symbol is held on the reels, the prize in the corresponding location on the prize map is also held. At the start of each free spin in GONG GONG LAI FU FEATURE, displayed prizes are redetermined for prize map squares that do not contain a held prize. Each new Gong symbol appearing in a free spin displays a prize value that it is the sum of all held prizes displayed on the prize map from the previous free spin within the same GONG GONG LAI FU FEATURE only. Each new Gong symbol appearing in a free spin resets the number of remaining free spins to 3 and is held in position for the duration of the GONG GONG LAI FU FEATURE. GONG GONG LAI FU FEATURE ends after all awarded free spins have been played or if Gong symbols appear in all 15 symbol positions. All prizes on Gong symbols are won at the end of feature.

JACKPOT SURPRISE



There is a chance that the GRAND JACKPOT is randomly won in bought games except when FREE GAMES FEATURE or GONG GONG LAI FU FEATURE is triggered.

TYPE OF FEATURES

Free Game + LP

REEL CONFIGURATION

5-Reel 3-Row Video Slot

PAYLINES

50, 25, 10 Lines (Denomination 1, 2)
5, 10, 25 Lines (Denomination 3, 4, 5)
5 Lines (Denomination 6, 7, 8)

DENOMINATIONS

1	2	3	4	5	6	7	8
1c	2c	5c	10c	20c	\$1	\$2	\$5
5c	10c	25c	50c	\$1	\$5	\$10	\$25
10c	20c	50c	\$1	\$2	\$10	\$20	\$50
50c	\$1	\$2.50	\$5	\$10	\$50	\$100	\$250
\$1	\$2	\$5	\$10	\$20	\$100	\$200	\$500

BET CONFIGURATIONS

1, 2, 3, 4, 5
1, 2, 3, 5, 8
1, 2, 3, 5, 10
1, 2, 5, 10, 20

MAX BET

250, 400, 500, 1000 (Denomination 1, 2)
125, 200, 250, 500 (Denomination 3, 4, 5)
25, 40, 50, 100 (Denomination 6, 7, 8)



The sound of Gong brings good fortune. A new set of reels will appear during Gong Gong Lai Fu Feature, awarding Credits or Bonuses. Each Gong symbol appearing is held for the entire Feature and adds to the prizes shown on the top of the reels. Grand Jackpot can be won when 15 Gong symbol are collected during Gong Gong Lai Fu Feature or as Jackpot Surprise during the bought games.

FREE GAMES FEATURE



Any 3 appearing on reels 2, 3 and 4 trigger the FREE GAMES FEATURE with 6 free games.

Reels used during the free games feature contain a greater total number of and .

Free games feature can be triggered again during the free games feature.

Free games feature starts after the GONG GONG LAI FU FEATURE ends if triggered in the same game.

If GONG GONG LAI FU FEATURE is triggered during the free games feature, any remaining free games resume after the GONG GONG LAI FU FEATURE ends.

GONG GONG LAI FU FEATURE



Any 6 or more trigger the GONG GONG LAI FU FEATURE and are held in position on the reels for the duration of the GONG GONG LAI FU FEATURE.

GONG GONG LAI FU FEATURE consists of 3 free spins.

During the GONG GONG LAI FU FEATURE, each symbol position becomes an individual spinning bonus reel.

In the GONG GONG LAI FU FEATURE, a prize map corresponding to the 15 symbol positions on the reels is displayed above the reels. Before the first free spin, each on the reels displays the prize from the corresponding location on the prize map. While a is held on the reels, the prize in the corresponding location on the prize map is also held. At the start of each free spin in GONG GONG LAI FU FEATURE, displayed prizes are redetermined for prize map squares that do not contain a held prize. Each new appearing in a free spin displays a prize value that is the sum of all held prizes displayed on the prize map from the previous free spin within the same GONG GONG LAI FU FEATURE only. Each new appearing in a free spin resets the number of remaining free spins to 3 and is held in position for the duration of the GONG GONG LAI FU FEATURE. GONG GONG LAI FU FEATURE ends after all awarded free spins have been played or if appear in all 15 symbol positions. All prizes on Gong symbols are won at the end of feature.

JACKPOT SURPRISE



There is a chance that the GRAND JACKPOT is randomly won in bought games except when FREE GAMES FEATURE or GONG GONG LAI FU FEATURE is triggered.



TYPE OF FEATURES

Free Game + LP

REEL CONFIGURATION

5-Reel 3-Row Video Slot

PAYLINES

50, 25, 10 Lines (Denomination 1, 2)
5, 10, 25 Lines (Denomination 3, 4, 5)
5 Lines (Denomination 6, 7, 8)

DENOMINATIONS

1	2	3	4	5	6	7	8
1c	2c	5c	10c	20c	\$1	\$2	\$5
5c	10c	25c	50c	\$1	\$5	\$10	\$25
10c	20c	50c	\$1	\$2	\$10	\$20	\$50
50c	\$1	\$2.50	\$5	\$10	\$50	\$100	\$250
\$1	\$2	\$5	\$10	\$20	\$100	\$200	\$500

BET CONFIGURATIONS

1, 2, 3, 4, 5
1, 2, 3, 5, 8
1, 2, 3, 5, 10
1, 2, 5, 10, 20

MAX BET

250, 400, 500, 1000 (Denomination 1, 2)
125, 200, 250, 500 (Denomination 3, 4, 5)
25, 40, 50, 100 (Denomination 6, 7, 8)

FU LAI CAI LAI 福来财来好运来 FORTUNE™

5 SEA LEGENDS™

TRIPLE FESTIVAL™

STACK WILD LUXURY™





Bold play opens the way to wild excitement and bigger wins. Increasing the bet level played improves several elements of gameplay, such as replacing a low paying symbol with a multiplying wild symbol on more and more reels, and unlocking a greater number of bonus and jackpot levels. Increasing credits bet per play makes a special payable available for the higher paying symbols. At the start of free games, the player can choose their own volatility by selecting a symbol to appear in the free games. Multiple jackpot chance features can be triggered and even mystery bonuses and jackpots can be won suddenly.

BET LEVEL: , WAY WINS MULTIPLIER, JACKPOT FEATURE and WILD COIN BONUS.

BET LEVEL (if available)	BECOMES ON THE REELS ACCORDING TO BET LEVEL PLAYED	WAY WINS MULTIPLIER	JACKPOT AND BONUS LEVELS BECOME AVAILABLE ACCORDING TO BET LEVEL PLAYED
Play 88 credits	ON REELS 1, 4 AND 5 ONLY	MULTIPLIED BY 5	MAJOR JACKPOT, GRAND JACKPOT, WILD COIN BONUS
Play 66 credits	ON REELS 1, 4 AND 5 ONLY	MULTIPLIED BY 4	MAJOR JACKPOT, GRAND JACKPOT, WILD COIN BONUS
Play 33 credits	ON REELS 4 AND 5 ONLY	MULTIPLIED BY 3	MAJOR JACKPOT, GRAND JACKPOT
Play 22 credits	ON REEL 5 ONLY	MULTIPLIED BY 2	MAJOR JACKPOT
Play 11 credits	NO REELS	NOT APPLICABLE	NO JACKPOTS AVAILABLE

The JACKPOT FEATURE cannot be triggered and the WILD COIN BONUS cannot occur when playing bet level 1.

FREE GAMES FEATURE



appearing on 3 or more consecutive reels beginning with the leftmost reel trigger the FREE GAMES FEATURE with 6 free games. Before FREE GAMES FEATURE starts, select 1 of the symbols from the available options. If the FREE GAMES FEATURE was triggered when playing bet level 2 or higher, the reels used during the FREE GAMES FEATURE are composed with the following symbols only: the symbol selected from the available options, , , , , and .

If the FREE GAMES FEATURE was triggered when playing bet level 1, the reels used during the FREE GAMES FEATURE are composed with the following symbols only: the symbol selected from the available options, , , , , and .

During the FREE GAMES FEATURE, appearing on 3 or more consecutive reels beginning with the leftmost reel award an additional 6 free games, however the selection of the symbol option is not made again.

FREE GAMES FEATURE starts after the JACKPOT FEATURE ends if triggered in the same game.

If the JACKPOT FEATURE is triggered during the free games, any remaining free games resume after the JACKPOT FEATURE ends.

JACKPOT FEATURE



There is a chance that 1 or more JACKPOT FEATURES are triggered when 1 or more appear on the reels in a bought game or free game.

In the JACKPOT FEATURE, pick from 15 until 3 matching symbols corresponding to a PRIZE are revealed by picking on the screen or by pressing the PLAY button which randomly picks a with each press of the button. If 3 are revealed, an additional JACKPOT FEATURE is awarded and the feature continues until a PRIZE is won. When 3 matching PRIZE have been revealed, the corresponding PRIZE is won and the JACKPOT FEATURE ends. Any additional JACKPOT FEATURE awarded, starts after the preceding JACKPOT FEATURE ends.

WILD COIN BONUS



There is a chance the WILD COIN BONUS may occur when 1 or more appear on the reels in a bought game or free game. When the WILD COIN BONUS occurs, one of the following PRIZES as displayed on the game screen is won.

PRIZE AMOUNT: equal to the total credits bet multiplied by either 10, 20, 30, 50 or 100 randomly as displayed.

BONUS: MINI BONUS or MINOR BONUS (available according to bet level played)

JACKPOT: MAJOR JACKPOT or GRAND JACKPOT (available according to bet level played)



TYPE OF FEATURES

Free Game + LP

REEL CONFIGURATION

5-Reel 3-Row Video Slot

PAYLINES

243 Ways

DENOMINATIONS

1	2	3	4	5	6	7
1c	2c	5c	10c	20c	\$1	\$2
5c	10c	25c	50c	\$1	\$5	\$10
10c	20c	50c	\$1	\$2	\$10	\$20
50c	\$1	\$2.50	\$5	\$10	\$50	\$100
\$1	\$2	\$5	\$10	\$20	\$100	\$200

BET CONFIGURATIONS

1, 2, 3, 6, 10

MAX BET

880



Bold play opens the way to wild excitement and bigger wins. Increasing the bet level played improves several elements of gameplay, such as replacing a low paying symbol with a compounding triple-multiplier wild symbol on more and more reels, and unlocking a greater number of bonus and jackpot levels. Increasing credits bet per play makes a special payable available for the higher paying symbols. Free games can be retrigged during the free games. Multiple jackpot chance features can be triggered and even mystery bonuses and jackpots can be won suddenly.

BET LEVEL (if available)	BECOMES ON THE REELS ACCORDING TO BET LEVEL PLAYED	JACKPOT AND BONUS LEVELS BECOME AVAILABLE ACCORDING TO BET LEVEL PLAYED
Play 88 credits	5 ON REELS 2, 3, 4 AND 5 ONLY	MAJOR JACKPOT - GRAND JACKPOT MINOR JACKPOT - WILD COIN BONUS
Play 66 credits	4 ON REELS 3, 4 AND 5 ONLY	MINOR JACKPOT - WILD COIN BONUS GRAND JACKPOT
Play 55 credits	3 ON REELS 4 AND 5 ONLY	MINOR JACKPOT - WILD COIN BONUS
Play 33 credits	2 ON REEL 5 ONLY	WILD COIN BONUS
Play 11 credits	NO REELS	NO JACKPOTS AVAILABLE

BET LEVEL: JACKPOT FEATURE and WILD COIN BONUS.

The JACKPOT FEATURE cannot be triggered and the WILD COIN BONUS cannot occur when playing bet level 1. One or more bet level options may not be available for selection.

FREE GAMES FEATURE

appearing on 3 or more consecutive reels beginning with the leftmost reel trigger the FREE GAMES FEATURE with 8 free games.



During Free Games Feature, reels contains Picture symbol only.

FREE GAMES FEATURE can be triggered again during the FREE GAMES FEATURE.

FREE GAMES FEATURE starts after the JACKPOT FEATURE ends if triggered in the same game.

If the JACKPOT FEATURE is triggered during the free games, any remaining free games resume after the JACKPOT FEATURE ends.

JACKPOT FEATURE

There is a chance that 1 or more JACKPOT FEATURES are triggered when 1 or more appear on the reels in a bought game or free game.



In the JACKPOT FEATURE, pick from 15 until 3 matching symbols corresponding to a PRIZE are revealed by picking on the screen or by pressing the PLAY button which randomly picks a with each press of the button.

The game automatically picks 1 from among the remaining after 2 minutes of no selection. If 3 are revealed, an additional JACKPOT FEATURE is awarded and the feature continues until a PRIZE is won.

When 3 matching PRIZE have been revealed, the corresponding PRIZE is won and the JACKPOT FEATURE ends.

Any additional JACKPOT FEATURE awarded, starts after the preceding JACKPOT FEATURE ends.

WILD COIN BONUS



There is a chance the WILD COIN BONUS may occur when 1 or more appear on the reels in a bought game or free game. When the WILD COIN BONUS occurs, one of the following PRIZES as displayed on the game screen is won.

PRIZE AMOUNT: equal to the total credits bet multiplied by either 10, 20, 30, 50 or 100 randomly as displayed.

BONUS: MINI BONUS or MINOR BONUS (available according to bet level played)

JACKPOT: MAJOR JACKPOT or GRAND JACKPOT (available according to bet level played)

TYPE OF FEATURES

Free Game + LP

REEL CONFIGURATION

5-Reel 3-Row Video Slot

PAYLINES

243 Ways

DENOMINATIONS

1	2	3	4	5	6	7
1c	2c	5c	10c	20c	\$1	\$2
5c	10c	25c	50c	\$1	\$5	\$10
10c	20c	50c	\$1	\$2	\$10	\$20
50c	\$1	\$2.50	\$5	\$10	\$50	\$100
\$1	\$2	\$5	\$10	\$20	\$100	\$200

BET CONFIGURATIONS

1, 2, 3, 6, 10

MAX BET

880



Bold play opens the way to wild excitement and bigger wins. Increasing the bet level played improves several elements of gameplay, such as replacing a low paying symbol with stacks of wild symbols on more and more reels, and unlocking a greater number of bonus and jackpot levels. Increasing credits bet per play makes a special payable available for the higher paying symbols. During free games, one reel becomes wild each free spin. Multiple jackpot chance features can be triggered and even mystery bonuses and jackpots can be won suddenly.

BET LEVEL (if available)	BECOMES ON THE REELS ACCORDING TO BET LEVEL PLAYED	JACKPOT AND BONUS LEVELS BECOME AVAILABLE ACCORDING TO BET LEVEL PLAYED
Play 80 credits	5 ON REELS 2, 3, 4 AND 5 ONLY	MAJOR JACKPOT - GRAND JACKPOT - MINOR BONUS - GRAND BONUS
Play 60 credits	4 ON REELS 3, 4 AND 5 ONLY	MAJOR JACKPOT - GRAND JACKPOT - MINOR BONUS
Play 50 credits	3 ON REELS 4 AND 5 ONLY	MAJOR JACKPOT - GRAND JACKPOT
Play 30 credits	2 ON REEL 5 ONLY	MAJOR JACKPOT
Play 11 credits	NO BONUS	NO JACKPOT AVAILABLE

BET LEVEL: JACKPOT FEATURE and WILD COIN BONUS.

The JACKPOT FEATURE cannot be triggered and the WILD COIN BONUS cannot occur when playing bet level 1. One or more bet level options may not be available for selection.

FREE GAMES FEATURE

appearing on 3 or more consecutive reels beginning with the leftmost reel trigger the FREE GAMES FEATURE with 8 free games.



In each free game, all symbols on 1 reel (within reels 2, 3, 4 or 5 according to bet level played) randomly becomes .

FREE GAMES FEATURE cannot be triggered again during the FREE GAMES FEATURE.

FREE GAMES FEATURE starts after the JACKPOT FEATURE ends if triggered in the same game.

If the JACKPOT FEATURE is triggered during the free games, any remaining free games resume after the JACKPOT FEATURE ends.

JACKPOT FEATURE

There is a chance that 1 or more JACKPOT FEATURES are triggered when 1 or more appear on the reels in a bought game or free game.



In the JACKPOT FEATURE, pick from 15 until 3 matching symbols corresponding to a PRIZE are revealed by picking on the screen or by pressing the PLAY button which randomly picks a with each press of the button.

The game automatically picks 1 from among the remaining after 2 minutes of no selection. If 3 are revealed, an additional JACKPOT FEATURE is awarded and the feature continues until a PRIZE is won.

When 3 matching PRIZE have been revealed, the corresponding PRIZE is won and the JACKPOT FEATURE ends. Any additional JACKPOT FEATURE awarded, starts after the preceding JACKPOT FEATURE ends.

WILD COIN BONUS



There is a chance the WILD COIN BONUS may occur when 1 or more appear on the reels in a bought game or free game. When the WILD COIN BONUS occurs, one of the following PRIZES as displayed on the game screen is won.

PRIZE AMOUNT: equal to the total credits bet multiplied by either 10, 20, 30, 50 or 100 randomly as displayed.

BONUS: MINI BONUS or MINOR BONUS (available according to bet level played)

JACKPOT: MAJOR JACKPOT or GRAND JACKPOT (available according to bet level played)



TYPE OF FEATURES

Free Game + LP

REEL CONFIGURATION

5-Reel 3-Row Video Slot

PAYLINES

243 Ways

DENOMINATIONS

1	2	3	4	5	6	7
1c	2c	5c	10c	20c	\$1	\$2
5c	10c	25c	50c	\$1	\$5	\$10
10c	20c	50c	\$1	\$2	\$10	\$20
50c	\$1	\$2.50	\$5	\$10	\$50	\$100
\$1	\$2	\$5	\$10	\$20	\$100	\$200

BET CONFIGURATIONS

1, 2, 3, 6, 10

MAX BET

880

GOD OF WINNING™

GREAT HAMMER

GOD OF WINNING™

SUPER SPEAR





Divine lightning storms of wild wins strike with enriching power. Three types of scatters leave behind a golden frame after they appear. These golden frames are resilient and held until they all become wild in a bought game. Trigger the free games feature with these golden frames in place and repeatedly reap the rewards as all held frames become wild during the feature. The excitement doesn't stop there, as all held frames that are in place at the start of the free games feature are still held after the feature ends. More winning energy is also on tap when the four-level progressive wheel randomly spins up a jackpot.

FREE GAMES FEATURE



There is a chance that free games are triggered when 1 or more appear. Free games consists of 7 free games.

Any held on the reels in the game that triggers the free games become held for the duration of the free games.

There is a chance in each free game that 1 or more symbol positions that do not contain held randomly become for one spin only.

After the free games end, all held that became during free games become held again.

Free games and JACKPOT WHEEL cannot be triggered in the same game.

JACKPOT WHEEL



There is a chance that the JACKPOT WHEEL is triggered when 1 or more appear. When the JACKPOT WHEEL is triggered, a wheel is displayed on the game screen and is spun once.

After the wheel is spun, 1 wheel segment indicated by the pointer at the top of the wheel is selected.

The wheel contains the following:

JACKPOTS: GRAND, MAJOR, MINOR and MINI

JACKPOT WHEEL and free games cannot be triggered in the same game. After a jackpot is won, the JACKPOT WHEEL ends.

WILD ZONE AND WILD BONUS



There is a chance that WILD ZONE occurs for 3, 4 or 5 bought games, randomly. When WILD ZONE occurs, the reel frame takes on the following appearance for the duration of the WILD ZONE: .

There is a chance that WILD CHANGE occurs in the WILD ZONE one time only. If WILD CHANGE occurs in the WILD ZONE, the WILD BONUS is triggered for up to 5 bought games, randomly.

During each WILD BONUS game, appear on 8 or more random symbol positions that become on stopped reels for 1 spin only.

If WILD BONUS is triggered, the WILD ZONE is extended until the WILD BONUS ends. All wins determined on stopped reels after the completion of symbol changes.

After all wins are determined in each game of the WILD BONUS, any are removed.



TYPE OF FEATURES

Free Game + LP

REEL CONFIGURATION

5-Reel 4-Row Video Slot

PAYLINES

25 Lines

DENOMINATIONS

1¢

BET CONFIGURATIONS

1, 2, 3, 4, 5, 6, 8, 10

MAX BET

75 Bet up to 750 Bet

(Depends on the above Bet Configurations)



TYPE OF FEATURES

Free Game + LP

REEL CONFIGURATION

5-Reel 4-Row Video Slot

PAYLINES

25 Lines

DENOMINATIONS

1¢

BET CONFIGURATIONS

1, 2, 3, 4, 5, 6, 8, 10

MAX BET

75 Bet up to 750 Bet

(Depends on the above Bet Configurations)





Divine lightning storms of wild wins strike with enriching power. Three types of scatters leave behind a golden frame after they appear. These golden frames are resilient and held until they all become wild in a bought game. Trigger the free games feature with these golden frames in place and repeatedly reap the rewards as all held frames become wild during the feature. The excitement doesn't stop there, as all held frames that are in place at the start of the free games feature are still held after the feature ends. More winning energy is also on tap when the four-level progressive wheel randomly spins up a jackpot.



FREE GAMES FEATURE



There is a chance that free games are triggered when 1 or more  appear. Free games consists of 7 free games.

Any held  on the reels in the game that triggers the free games become held  for the duration of the free games.

There is a chance in each free game that 1 or more symbol positions that do not contain held  randomly become  for one spin only.

After the free games end, all held  that became  during free games become held  again.

Free games and JACKPOT WHEEL cannot be triggered in the same game.

JACKPOT WHEEL



There is a chance that the JACKPOT WHEEL is triggered when 1 or more  appear. When the JACKPOT WHEEL is triggered, a wheel is displayed on the game screen and is spun once.

After the wheel is spun, 1 wheel segment indicated by the pointer at the top of the wheel is selected.

The wheel contains the following:

JACKPOTS: GRAND, MAJOR, MINOR and MINI

Pressing the PLAY button or touching the game screen spins the wheel. JACKPOT WHEEL and free games cannot be triggered in the same game. After a jackpot is won, the JACKPOT WHEEL ends.

WILD ZONE AND WILD BONUS



There is a chance that WILD ZONE occurs for 3, 4 or 5 bought games, randomly. When WILD ZONE occurs, the reel frame takes on the following appearance for the duration of the WILD ZONE: .

There is a chance that WILD CHANGE occurs in the WILD ZONE one time only. If WILD CHANGE occurs in the WILD ZONE, the WILD BONUS is triggered for up to 5 bought games, randomly.

During each WILD BONUS game,  appear on 8 or more random symbol positions that become  on stopped reels for 1 spin only.

If WILD BONUS is triggered, the WILD ZONE is extended until the WILD BONUS ends. All wins determined on stopped reels after the completion of symbol changes.

After all wins are determined in each game of the WILD BONUS, any  are removed.

TRIPLE TREASURE POT™





Win big with an abundance of multiple features played at the same time. The three pots on screen represent bonus feature elements that can occur individually or combined in a single feature. Bonus feature elements consist of special credit prize symbols that nudge to fill their reels, special prize symbols awarding instant credit prizes and bonus/jackpot coins that are collected for big payouts, and expanding reels increasing the number of wins. There are also three randomly triggered prize actions that either instantly pay all displayed prizes on special symbols as shown, add on to prize values before there are paid, or multiplies prize values before they are paid.

TIGER FEATURE



There is a chance that the TIGER FEATURE is triggered when 1 or more appear.

TIGER FEATURE awards 5 free spins.

Different reels are used during the TIGER FEATURE. Any reel with 1, 2 or 3 nudges to show 4 when any ACTION SYMBOL appears on reel 5.

Line wins are determined only once before any reel nudge occurs.

Prizes on are won only once after any reel nudge occurs.

Any other FEATURE triggered during the TIGER FEATURE starts after the TIGER FEATURE ends, except ACTION PRIZES FEATURE.

DRAGON FEATURE



There is a chance that the DRAGON FEATURE is triggered when 1 or more appear. DRAGON FEATURE awards 10 free spins. Different reels are used during the DRAGON FEATURE. 1 of the following is displayed on each .

- CREDIT PRIZE: 100, 500 or 1000 credits multiplied by bet multiplier as displayed.
- MINI, MINOR, MAJOR or GRAND

Each CREDIT PRIZE displayed on is won. Each MINI, MINOR, MAJOR or GRAND displayed on is collected in its corresponding meter on the screen.

Each appearing awards 1 additional free spin.

OX FEATURE



There is a chance that the OX FEATURE is triggered when 1 or more appear. OX FEATURE awards 5 free spins.

Different reels are used during the OX FEATURE.

Before the OX FEATURE starts, all reels are expanded upward 2 rows of symbols.

Any other FEATURE triggered during the OX FEATURE starts after the OX FEATURE ends, except ACTION PRIZES FEATURE.

ACTION PRIZES FEATURE



Any combination of 1 or more and 1 ACTION SYMBOL trigger the corresponding ACTION PRIZE shown below.

ACTION SYMBOL	ACTION PRIZE
	Each prize displayed is won.
	Each prize displayed on is won after being increased by the credit value displayed on .
	Each displayed on is won after being multiplied by the multiplier displayed on .

TYPE OF FEATURES

Free Game + LP

REEL CONFIGURATION

5-Reel 4-Row Video Slot
5-Reel 6-Row (During the Ox Feature only)

PAYLINES

50 Lines
100 Lines (During the Ox Feature only)

DENOMINATIONS

1¢ 2¢, 5¢
10¢, 20¢, 50¢
\$1, \$2, \$5

BET CONFIGURATIONS

1, 2, 3, 6, 10

MAX BET

880



Win big with an abundance of multiple features played at the same time. The three pots on screen represent bonus feature elements that can occur individually or combined in a single feature. Bonus feature elements consist of special credit prize symbols that nudge to fill their reels, special prize symbols awarding instant credit prizes and bonus/jackpot coins that are collected for big payouts, and expanding reels increasing the number of wins. There are also three randomly triggered prize actions that either instantly pay all displayed prizes on special symbols as shown, add on to prize values before there are paid, or multiplies prize values before they are paid.

TIGER FEATURE



There is a chance that the TIGER FEATURE is triggered when 1 or more appear.
 TIGER FEATURE awards 5 free spins.
 Any reel with 1, 2 or 3 nudges to show 4 when any ACTION SYMBOL appears on reel 5.
 Line wins are determined only once before any reel nudge occurs.
 Prizes on are won only once after any reel nudge occurs.
 Any other FEATURE triggered during the TIGER FEATURE starts after the TIGER FEATURE ends, except ACTION PRIZES FEATURE.

DRAGON FEATURE



There is a chance that the DRAGON FEATURE is triggered when 1 or more appear.
 DRAGON FEATURE awards 10 free spins.
 Each CREDIT PRIZE displayed on is won.
 Each MINI, MINOR, MAJOR or GRAND displayed on is collected in its corresponding meter on the screen.
 Each appearing awards 1 additional free spin.

OX FEATURE



There is a chance that the OX FEATURE is triggered when 1 or more appear.
 OX FEATURE awards 5 free spins.
 Different reels are used during the OX FEATURE.
 Before the OX FEATURE starts, all reels are expanded upward 2 rows of symbols.
 Any other FEATURE triggered during the OX FEATURE starts after the OX FEATURE ends, except ACTION PRIZES FEATURE.

ACTION PRIZES FEATURE



Any combination of 1 or more and 1 ACTION SYMBOL trigger the corresponding ACTION PRIZE shown below.

ACTION SYMBOL	ACTION PRIZE
	Each prize displayed is won.
	Each prize displayed on is won after being increased by the credit value displayed on .
	Each displayed on is won after being multiplied by the multiplier displayed on .



TYPE OF FEATURES

Free Game + LP

REEL CONFIGURATION

5-Reel 4-Row Video Slot
 5-Reel 6-Row (During the Ox Feature only)

PAYLINES

50 Lines
 100 Lines (During the Ox Feature only)

DENOMINATIONS

1c 2c, 5c
 10c, 20c, 50c
 \$1, \$2, \$5

BET CONFIGURATIONS

1, 2, 3, 6, 10

MAX BET

880

LONGFUZHU™





Mighty dragon breathe fire to unlock superb win. Jackpot Feature randomly triggered in bought games. All prizes displayed on the orb symbols are held in the position for the duration of the DRAGON ORB FEATURE are won including bonus and jackpots. Reels used during the FREE GAMES FEATURE contain a greater total number of

FREE GAMES FEATURE



Any 3 appearing on reels 2, 3 and 4 trigger the FREE GAMES FEATURE with 6 free games. Reels used during the FREE GAMES FEATURE contain a greater total number of .

FREE GAMES FEATURE can be triggered again during the FREE GAMES FEATURE. FREE GAMES FEATURE starts after the DRAGON ORB FEATURE ends if triggered in the same game.

If the DRAGON ORB FEATURE is triggered during FREE GAMES FEATURE, any remaining free games resume after the DRAGON ORB FEATURE ends.

DRAGON ORB FEATURE



Any 6 or more appearing in a bought game or free game trigger the DRAGON ORB FEATURE. When DRAGON ORB FEATURE is triggered, 3 free spins are awarded. During the DRAGON ORB FEATURE, each symbol position becomes an individual spinning bonus reel.

Before the DRAGON ORB FEATURE starts, all reels are expanded upward 1 row of symbols and reel 5 is locked. In each free spin, reel 5 is locked if no new appearing on the reels. At the start of DRAGON ORB FEATURE, only 6 appear on random symbol positions on reels 1, 2, 3 and 4 and are held in the position for the duration of the DRAGON ORB FEATURE. During the DRAGON ORB FEATURE, any newly appearing in a free spin resets the number of remaining free spins to 3 and are held in position until the DRAGON ORB FEATURE ends.

PRIZES	ACTION PRIZE
MULTIPLIER x2, x3, x6, x18	Each prize displayed on held appearing on one row is being multiplied by the multiplier displayed on its reel 5.
PRIZE AMOUNT each reel is 25, 45, 60, 90, 100, 150, 200 or 250 credits multiplied by an multiplier as displayed	Each prize displayed on held appearing on one row is being increased by the amount value displayed on its reel 5.
BONUS x11, x15, x20, x25, x30, x35, x40, x45, x50, x55, x60, x65, x70, x75, x80, x85, x90, x95, x100, x105, x110, x115, x120, x125, x130, x135, x140, x145, x150, x155, x160, x165, x170, x175, x180, x185, x190, x195, x200, x205, x210, x215, x220, x225, x230, x235, x240, x245, x250, x255, x260, x265, x270, x275, x280, x285, x290, x295, x300, x305, x310, x315, x320, x325, x330, x335, x340, x345, x350, x355, x360, x365, x370, x375, x380, x385, x390, x395, x400, x405, x410, x415, x420, x425, x430, x435, x440, x445, x450, x455, x460, x465, x470, x475, x480, x485, x490, x495, x500, x505, x510, x515, x520, x525, x530, x535, x540, x545, x550, x555, x560, x565, x570, x575, x580, x585, x590, x595, x600, x605, x610, x615, x620, x625, x630, x635, x640, x645, x650, x655, x660, x665, x670, x675, x680, x685, x690, x695, x700, x705, x710, x715, x720, x725, x730, x735, x740, x745, x750, x755, x760, x765, x770, x775, x780, x785, x790, x795, x800, x805, x810, x815, x820, x825, x830, x835, x840, x845, x850, x855, x860, x865, x870, x875, x880, x885, x890, x895, x900, x905, x910, x915, x920, x925, x930, x935, x940, x945, x950, x955, x960, x965, x970, x975, x980, x985, x990, x995, x1000	Each prize displayed on held appearing on one row is being increased by the bonus value displayed on its reel 5.
JACKPOT GRAND JACKPOT	Each prize displayed on held appearing on one row is being increased by the jackpot value displayed on its reel 5.

When the reel 5 unlocks, it will spin automatically and each symbol position displayed 1 of the available prizes as shown below.

DRAGON ORB FEATURE ends after all awarded free spins have been played or if appear in all 16 symbol positions on reels 1, 2, 3 and 4.



MYSTERY JACKPOT AWARD

There is a chance that the GRAND JACKPOT is randomly won in bought games except when FREE GAMES FEATURE or DRAGON ORB FEATURE is triggered.



TYPE OF FEATURES

Free Game + LP

REEL CONFIGURATION

5-Reel 3-Row Video Slot

PAYLINES

50 Lines (Denomination 1, 2)
25 Lines (Denomination 3, 4, 5)
5 Lines (Denomination 6, 7, 8)

DENOMINATIONS

1	2	3	4	5	6	7	8
1c	2c	5c	10c	20c	\$1	\$2	\$5
5c	10c	25c	50c	\$1	\$5	\$10	\$25
10c	20c	50c	\$1	\$2	\$10	\$20	\$50
50c	\$1	\$2.50	\$5	\$10	\$50	\$100	\$250
\$1	\$2	\$5	\$10	\$20	\$100	\$200	\$500

BET CONFIGURATIONS

1, 2, 3, 4, 5
1, 2, 3, 5, 8
1, 2, 3, 5, 10
1, 2, 5, 10, 20

MAX BET

400, 640, 800, 1600 (Denomination 1, 2)
200, 320, 400, 800 (Denomination 3, 4, 5)
40, 64, 80, 160 (Denomination 6, 7, 8)



Mighty dragon breathe fire to unlock superb win. Jackpot Feature randomly triggered in bought games. All prizes displayed on the orb symbols are held in the position for the duration of the DRAGON ORB FEATURE are won including bonus and jackpots. During the FREE GAMES FEATURE, substituting in a win becomes .

FREE GAMES FEATURE



Any 3 appearing on reels 2, 3 and 4 trigger the FREE GAMES FEATURE with 6 free games.

During the FREE GAMES FEATURE, substituting in a win becomes . The sum of multipliers from every that substitutes in a win multiplies the pay for that win.

FREE GAMES FEATURE can be triggered again during the FREE GAMES FEATURE. FREE GAMES FEATURE starts after the DRAGON ORB FEATURE ends if triggered in the same game.

If the DRAGON ORB FEATURE is triggered during the FREE GAMES FEATURE, any remaining free games resume after the DRAGON ORB FEATURE ends.

DRAGON ORB FEATURE



Any 6 or more appearing in a bought game or free game trigger the DRAGON ORB FEATURE.

When DRAGON ORB FEATURE is triggered, 3 free spins are awarded. During the DRAGON ORB FEATURE, each symbol position becomes an individual spinning bonus reel.

Before the DRAGON ORB FEATURE starts, all reels are expanded upward 1 row of symbols and reel 5 is locked. In each free spin, reel 5 is locked if no new appearing on the reels. At the start of DRAGON ORB FEATURE, only 6 appear on random symbol positions on reels 1, 2, 3 and 4 and are held in the position for the duration of the DRAGON ORB FEATURE. During the DRAGON ORB FEATURE, any newly appearing in a free spin resets the number of remaining free spins to 3 and are held in position until the DRAGON ORB FEATURE ends.

PRIZES	ACTION PRIZE
MULTIPLIER x2, x3 or x4	Each prize displayed on held appearing on one reel is being multiplied by the multiplier displayed on its reel 5.
PRIZE AMOUNT each equal to 10, 15, 20, 30, 40, 50, 100, 150, 200 or 250 credits multiplied by the multiplier as displayed	Each prize displayed on held appearing on one reel is being increased by the amount value displayed on its reel 5.
BONUS MINI BONUS OF 3, 5, 10, 20	Each prize displayed on held appearing on one reel is being increased by the bonus value displayed on its reel 5.
JACKPOT MID-GAME JACKPOT	Each prize displayed on held appearing on one reel is being increased by the jackpot value displayed on its reel 5.

When the reel 5 unlocks, it will spin automatically and each symbol position displayed 1 of the available prizes as shown below.

DRAGON ORB FEATURE ends after all awarded free spins have been played or if appear in all 16 symbol positions on reels 1, 2, 3 and 4.

TYPE OF FEATURES

Free Game + LP

REEL CONFIGURATION

5-Reel 3-Row Video Slot

PAYLINES

50 Lines (Denomination 1, 2)

25 Lines (Denomination 3, 4, 5)

5 Lines (Denomination 6, 7, 8)

DENOMINATIONS

1	2	3	4	5	6	7	8
1c	2c	5c	10c	20c	\$1	\$2	\$5
5c	10c	25c	50c	\$1	\$5	\$10	\$25
10c	20c	50c	\$1	\$2	\$10	\$20	\$50
50c	\$1	\$2.50	\$5	\$10	\$50	\$100	\$250
\$1	\$2	\$5	\$10	\$20	\$100	\$200	\$500

BET CONFIGURATIONS

1, 2, 3, 4, 5

1, 2, 3, 5, 8

1, 2, 3, 5, 10

1, 2, 5, 10, 20

MAX BET

400, 640, 800, 1600 (Denomination 1, 2)

200, 320, 400, 800 (Denomination 3, 4, 5)

40, 64, 80, 160 (Denomination 6, 7, 8)



MYSTERY JACKPOT AWARD

There is a chance that the GRAND JACKPOT is randomly won in bought games except when FREE GAMES FEATURE or DRAGON ORB FEATURE is triggered.

BINGO JACKPOT™



12	BINGO JACKPOT	\$5,000.00
10	BINGO JACKPOT	\$2,000.00
9	BINGO JACKPOT	\$500.00
8	BINGO JACKPOT	\$200.00
7	BINGO BONUS	\$40.00
6	BINGO BONUS	\$20.00
5	BINGO BONUS	\$10.00

12	BINGO JACKPOT	\$5,000.00
10	BINGO JACKPOT	\$2,000.00
9	BINGO JACKPOT	\$500.00
8	BINGO JACKPOT	\$200.00
7	BINGO BONUS	\$40.00
6	BINGO BONUS	\$20.00
5	BINGO BONUS	\$10.00





Your conventional Bingo Game showcased with additional exciting features. Play and get a chance to win Multiple BINGO bonus win from 12 patterns of BINGO Win. Collect Prize Symbols and get a chance to Win Credit Prizes, Bonuses and Jackpots.

FREE GAMES FEATURE



Any 3 or more  trigger FREE GAMES FEATURE with 6 free games.

FREE GAMES FEATURE can be triggered again during the FREE GAMES FEATURE.

FREE GAMES FEATURE starts after COLLECT FEATURE or BINGO COLLECT FEATURE ends if triggered in the same game.

COLLECT FEATURE



Any 6 or more PRIZE SYMBOLS appearing in a bought or a free game trigger the COLLECT FEATURE except when there is a PRIZE SYMBOL appearing in the SPECIAL WINDOW (center position on reel 3).

Any PRIZE SYMBOLS appearing in the game that triggers the COLLECT FEATURE are held in position for the duration of the COLLECT FEATURE.

Each symbol position becomes an individual spinning bonus reel during the COLLECT FEATURE.

When the COLLECT FEATURE is triggered, 3 free spins are awarded. Each newly appearing PRIZE SYMBOL in a free spin resets the number of remaining free spins to 3 and is held in position until the COLLECT FEATURE ends. COLLECT FEATURE ends after all awarded free spins have been played or if BINGO COLLECT FEATURE is triggered.

BINGO COLLECT FEATURE



During bought games or FREE GAMES FEATURE, any 6 or more PRIZE SYMBOLS appearing on the reels trigger the BINGO COLLECT FEATURE only when there is a PRIZE SYMBOL appearing in the SPECIAL WINDOW (center position on reel 3).

Alternatively, any PRIZE SYMBOL appearing in the SPECIAL WINDOW (center position on reel 3) during the COLLECT FEATURE triggers the BINGO COLLECT FEATURE.

All PRIZE SYMBOLS appearing in the game that triggers the BINGO COLLECT FEATURE are held in position for the duration of the BINGO COLLECT FEATURE. When the BINGO COLLECT FEATURE is triggered, 3 free spins are awarded. All reels are expanded to 5 symbol positions during the BINGO COLLECT FEATURE. Each symbol position becomes an individual spinning bonus reel during the BINGO COLLECT FEATURE. Any newly appearing PRIZE SYMBOL in a free spin resets the number of remaining free spins to 3 and is held in position until the BINGO COLLECT FEATURE ends. Any 5 PRIZE SYMBOLS appearing on the same reel, row or diagonally complete a BINGO LINE during the BINGO COLLECT FEATURE. BINGO LINE wins are only paid in the same spin in which they become completed. There are no pays for BINGO LINES 1 to 4. BINGO COLLECT FEATURE ends after all awarded free spins have been played or if BINGO LINE 12 is formed.

TYPE OF FEATURES

Free Game + LP

REEL CONFIGURATION

5-Reel 3-Row Video Slot
(Up to 5-Reel 5-Rows during the Bingo Collect Feature)

PAYLINES

50 Lines

DENOMINATIONS

1c

BET CONFIGURATIONS

- 1, 2, 3, 4, 5
- 1, 2, 3, 4, 6
- 1, 2, 3, 4, 8
- 1, 2, 3, 5, 8
- 1, 2, 3, 5, 10
- 1, 2, 3, 6, 10

MAX BET

500, 600, 800, 1000



Your conventional Bingo Game showcased with additional exciting features. Play and get a chance to win Multiple BINGO bonus win from 12 patterns of BINGO Win. Collect Prize Symbols and get a chance to Win Credit Prizes, Bonuses and Jackpots.

FREE GAMES FEATURE



Any 3 or more  trigger FREE GAMES FEATURE with 6 free games.

FREE GAMES FEATURE can be triggered again during the FREE GAMES FEATURE.

FREE GAMES FEATURE starts after COLLECT FEATURE or BINGO COLLECT FEATURE ends if triggered in the same game.

COLLECT FEATURE



Any 6 or more PRIZE SYMBOLS appearing in a bought or a free game trigger the COLLECT FEATURE except when there is a PRIZE SYMBOL appearing in the SPECIAL WINDOW (center position on reel 3).

Any PRIZE SYMBOLS appearing in the game that triggers the COLLECT FEATURE are held in position for the duration of the COLLECT FEATURE.

Each symbol position becomes an individual spinning bonus reel during the COLLECT FEATURE.

When the COLLECT FEATURE is triggered, 3 free spins are awarded. Each newly appearing PRIZE SYMBOL in a free spin resets the number of remaining free spins to 3 and is held in position until the COLLECT FEATURE ends. COLLECT FEATURE ends after all awarded free spins have been played or if BINGO COLLECT FEATURE is triggered.

BINGO COLLECT FEATURE



During bought games or FREE GAMES FEATURE, any 6 or more PRIZE SYMBOLS appearing on the reels trigger the BINGO COLLECT FEATURE only when there is a PRIZE SYMBOL appearing in the SPECIAL WINDOW (center position on reel 3).

Alternatively, any PRIZE SYMBOL appearing in the SPECIAL WINDOW (center position on reel 3) during the COLLECT FEATURE triggers the BINGO COLLECT FEATURE.

All PRIZE SYMBOLS appearing in the game that triggers the BINGO COLLECT FEATURE are held in position for the duration of the BINGO COLLECT FEATURE. When the BINGO COLLECT FEATURE is triggered, 3 free spins are awarded. All reels are expanded to 5 symbol positions during the BINGO COLLECT FEATURE. Each symbol position becomes an individual spinning bonus reel during the BINGO COLLECT FEATURE. Any newly appearing PRIZE SYMBOL in a free spin resets the number of remaining free spins to 3 and is held in position until the BINGO COLLECT FEATURE ends. Any 5 PRIZE SYMBOLS appearing on the same reel, row or diagonally complete a BINGO LINE during the BINGO COLLECT FEATURE. BINGO LINE wins are only paid in the same spin in which they become completed. There are no pays for BINGO LINES 1 to 4. BINGO COLLECT FEATURE ends after all awarded free spins have been played or if BINGO LINE 12 is formed.



TYPE OF FEATURES

Free Game + LP

REEL CONFIGURATION

5-Reel 3-Row Video Slot
(Up to 5-Reel 5-Rows during the Bingo Collect Feature)

PAYLINES

50 Lines

DENOMINATIONS

1c

BET CONFIGURATIONS

- 1, 2, 3, 4, 5
- 1, 2, 3, 4, 6
- 1, 2, 3, 4, 8
- 1, 2, 3, 5, 8
- 1, 2, 3, 5, 10
- 1, 2, 3, 6, 10

MAX BET

500, 600, 800, 1000



MUSO™ TRIPLE-32HB

mu·so [mōō - sō] *adj.*
being the only one of its kind;
unlike anything else.



Stunning HD Graphics

Breathtakingly clear and bursting with rich colors displayed on three large 32-inch LCD monitor.



New Face Design

Equipped with Qi standard wireless charger. USB charging port also provided for player convenience.



A stunning new honeycomb cabinet LED display to attract players.

Thoughtful touches to keep them comfortable.

All designed for an unparalleled gaming experience.



New honeycomb LED

Creating a unique visual experience not replicated in the market.



Ergonomic Button Deck

Inviting wrist rest and expansive glass table. Completely new interface design displayed on a 13.3-inch LCD deck.

DIMENSION

Upright Height (Tower Light Included)

93.1 in (2365 mm)

Upright Height (Tower Light Excluded)

89.4 in (2271 mm)

Width

31.9 in (810 mm)

Depth

27 in (685.4 mm)

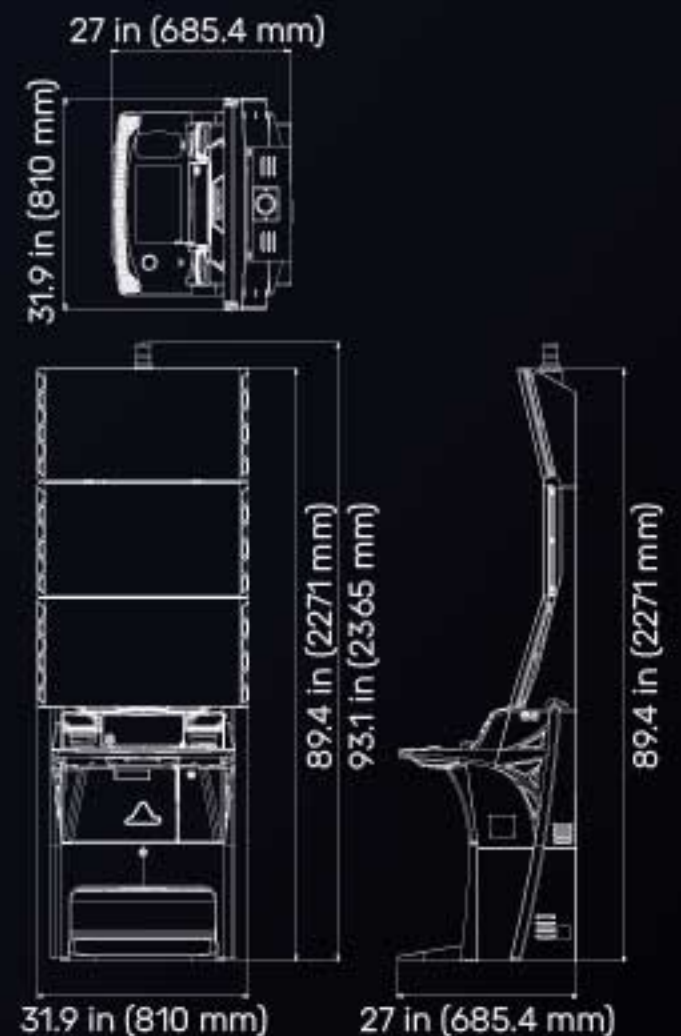

BUILT FOR EXCELLENCE

BOMB

COLLECTOR™ GOLD HEIST

BOMB

COLLECTOR™ TREASURE HEIST

The screen displays the game title "BOMB COLLECTOR GOLD HEIST". The top section shows a "GRAND" jackpot of \$5,000.00 and a "MAJOR" jackpot of \$500.00. Below this, the "PROGRESS" bar shows \$25.00 and the "BONUS" bar shows \$10.00. A central graphic features a bomb with a skull and crossbones. A banner reads "HOLD BOMB SPIN" with a note: "3 STACKED ♠ TRIGGER THE HOLD BOMB SPIN WITH 3 TYPES OF FEATURES AVAILABLE." The bottom section shows a 5x3 grid of symbols including a bomb, a skull, and various playing cards (A, K, 9, 10, J, Q). At the bottom of the screen, the coin value is 1c, the credit is 2000, the bet is 375, and the win is 0.

The screen displays the game title "BOMB COLLECTOR TREASURE HEIST". The top section shows a "GRAND" jackpot of \$5,000.00 and a "MAJOR" jackpot of \$500.01. Below this, the "PROGRESS" bar shows \$25.02 and the "BONUS" bar shows \$10.03. A central graphic features a bomb with a skull and crossbones. A banner reads "HOLD BOMB SPIN" with a note: "3 STACKED ♠ TRIGGER THE HOLD BOMB SPIN WITH 3 TYPES OF FEATURES AVAILABLE." The bottom section shows a 5x3 grid of symbols including a bomb, a skull, and various playing cards (A, K, 9, 10, J, Q). At the bottom of the screen, the coin value is 1c, the credit is 2000, the bet is 375, and the win is 0.





Be ready for surprises when these bombs explode. Exploding bombs can award WILD BOOM, PRIZE BLAST, FREE GAMES EXPLOSION or JACKPOT FEATURE. With wild appearing it may also award 1 of the available Jackpots: GRAND, MAJOR, MINOR, MINI.

HOLD BOMB SPIN



1 free HOLD BOMB SPIN is triggered if 3 stacked appear on at least any one reel in bought games only. Any appearing in the bought game that triggers the HOLD BOMB SPIN or appearing in any additionally awarded free HOLD BOMB SPIN are held in position until the completion of the last HOLD BOMB SPIN. Each symbol position becomes an individual spinning bonus reel during HOLD BOMB SPIN. 1 additional free HOLD BOMB SPIN is awarded if any 1 or more new appear in any HOLD BOMB SPIN. If appears in all 15 symbol positions, no additional HOLD BOMB SPIN is awarded and the reels do not spin. HOLD BOMB SPIN starts after the JACKPOT FEATURE ends if triggered in the same bought game. After the last HOLD BOMB SPIN only, all held on the reels explode to award 1 of the following symbol change features: WILD BOOM, PRIZE BLAST or FREE GAMES EXPLOSION.

WILD BOOM



If WILD BOOM is awarded, each held explodes to become , or . If WILD BOOM is awarded, line wins are determined again and any resulting line wins are paid. The sum of the multipliers from every / that substitutes in a win multiplies the pay for that win.

PRIZE BLAST



If PRIZE BLAST is awarded, each held explodes to become awarding 1 of the following prizes: PRIZE AMOUNT: 20, 30, 40, 50, 60, 75, 100, 125, 150, 200, 250, 300, 400, 500, 750, 1000, 1500, 2000, 2500 or 3000 credits multiplied by bet multiplier as displayed.

JACKPOT: MINI, MINOR, MAJOR or GRAND (only 1 may display a JACKPOT).

If PRIZE BLAST is awarded, line wins are not determined again and therefore any line wins are not paid again.

FREE GAMES EXPLOSION



If FREE GAMES EXPLOSION is awarded, each held explodes to become awarding 1 of the following: 1, 2, 3, 4 or 5 free games. The sum of free games displayed on are awarded.

If FREE GAMES EXPLOSION is awarded, line wins are not determined again and therefore any line wins are not paid again.

Each free game, any appearing explodes to become awarding 1 of the following:

PRIZE AMOUNT: 20, 30, 40, 50, 75, 100, 125, 150, 200, 250, 300, 400, 500 or 750 credits multiplied by bet multiplier as displayed.

+1 SPIN: awards 1 additional free game.

Each free game, any appearing explodes to become awarding 1 of the following:

PRIZE AMOUNT: 100, 125, 150, 200, 250, 300, 400, 500, 750 or 1000 credits multiplied by bet multiplier as displayed.

+1 SPIN: awards 1 additional free game.

Each free game, any appearing explodes to become awarding 1 of the following:

PRIZE AMOUNT: 250, 300, 400, 500, 750, 1000, 1500, 2000, 2500 or 3000 credits multiplied by bet multiplier as displayed.

+1 SPIN: awards 1 additional free game Credits bet and lines played during the free games are the same as the game that triggered the free games.

JACKPOT FEATURE



There is a chance that the JACKPOT FEATURE may be triggered when 1 or more appear in bought games only. In the JACKPOT FEATURE, select from 12 icons until 3 matching symbols corresponding to a JACKPOT level are revealed.

When 3 matching JACKPOT level symbols have been revealed, the corresponding JACKPOT level is won and the JACKPOT FEATURE ends.

TYPE OF FEATURES

Free Game + LP

REEL CONFIGURATION

5-Reel 3-Row Video Slot

PAYLINES

30 Lines

DENOMINATIONS

1c

BET CONFIGURATIONS

1, 2, 3, 4, 5, 6, 7, 8, 9, 10

MIN/MAX BET

75 Bet up to 750 Bet

(Depends on the above Bet Configurations)



Be ready for surprises when these bombs explode. Exploding bombs can award WILD BOOM, PRIZE BLAST, FREE GAMES EXPLOSION or JACKPOT FEATURE. With wild appearing it may also award 2 of the available Jackpots: GRAND, MAJOR, MINOR, MINI.

HOLD BOMB SPIN



1 free HOLD BOMB SPIN is triggered if 3 stacked appear on at least any one reel in bought games only. Any appearing in the bought game that triggers the HOLD BOMB SPIN or appearing in any additionally awarded free

HOLD BOMB SPIN are held in position until the completion of the last HOLD BOMB SPIN. Each symbol position becomes an individual spinning bonus reel during HOLD BOMB SPIN. 1 additional free HOLD BOMB SPIN is awarded if any 1 or more new appear in any HOLD BOMB SPIN. If appears in all 15 symbol positions, no additional HOLD BOMB SPIN is awarded and the reels do not spin. HOLD BOMB SPIN starts after the JACKPOT FEATURE ends if triggered in the same bought game. After the last HOLD BOMB SPIN only, all held on the reels explode to award 1 of the following symbol change features: WILD BOOM, PRIZE BLAST or FREE GAMES EXPLOSION.

WILD BOOM



If WILD BOOM is awarded, each held explodes to become , or . If WILD BOOM is awarded, line wins are determined again and any resulting line wins are paid. The sum of the multipliers from every / that substitutes in a win multiplies the pay for that win.

PRIZE BLAST



If PRIZE BLAST is awarded, each held explodes to become awarding 1 of the following prizes: PRIZE AMOUNT: 20, 30, 40, 50, 60, 75, 100, 125, 150, 200, 250, 300, 400, 500, 750, 1000, 1500, 2000, 2500 or 3000 credits multiplied by bet multiplier as displayed.

JACKPOT: MINI, MINOR, MAJOR or GRAND (only 1 may display a JACKPOT).

If PRIZE BLAST is awarded, line wins are not determined again and therefore any line wins are not paid again.

FREE GAMES EXPLOSION



If FREE GAMES EXPLOSION is awarded, each held explodes to become awarding 1 of the following: 1, 2, 3, 4 or 5 free games. The sum of free games displayed on are awarded.

If FREE GAMES EXPLOSION is awarded, line wins are not determined again and therefore any line wins are not paid again.

Each free game, any appearing explodes to become awarding 1 of the following:

PRIZE AMOUNT: 20, 30, 40, 50, 75, 100, 125, 150, 200, 250, 300, 400, 500 or 750 credits multiplied by bet multiplier as displayed.

+1 SPIN: awards 1 additional free game.

Each free game, any appearing explodes to become awarding 1 of the following:

PRIZE AMOUNT: 100, 125, 150, 200, 250, 300, 400, 500, 750 or 1000 credits multiplied by bet multiplier as displayed.

+1 SPIN: awards 1 additional free game.

Each free game, any appearing explodes to become awarding 1 of the following:

PRIZE AMOUNT: 250, 300, 400, 500, 750, 1000, 1500, 2000, 2500 or 3000 credits multiplied by bet multiplier as displayed.

+1 SPIN: awards 1 additional free game Credits bet and lines played during the free games are the same as the game that triggered the free games.

JACKPOT FEATURE



There is a chance that the JACKPOT FEATURE may be triggered when 1 or more appear in bought games only. In the JACKPOT FEATURE, select from 12 icons until 3 matching symbols corresponding to a JACKPOT level are revealed.

When 3 matching JACKPOT level symbols have been revealed, the corresponding JACKPOT level is won and the JACKPOT FEATURE ends.



TYPE OF FEATURES

Free Game + LP

REEL CONFIGURATION

5-Reel 3-Row Video Slot

PAYLINES

30 Lines

DENOMINATIONS

1c

BET CONFIGURATIONS

1, 2, 3, 4, 5, 6, 7, 8, 9, 10

MIN/MAX BET

75 Bet up to 750 Bet

(Depends on the above Bet Configurations)

DIAMOND PAYS™

ORIENTAL PRINCESS

DIAMOND PAYS™

ARABIAN OASIS





Successive chains of prize collecting features award dazzling treasure. Especially-persistent bonus symbols trigger free spins in which there is a greater chance to trigger a prize collection feature. After completing any prize collection feature, the especially-persistent bonus symbols trigger more free spins in which there is a greater chance to trigger the prize collection feature again. All credit prizes and jackpots on the held bonus symbols at the end of the prize collection feature are won. Additionally, mystery bonuses and jackpots can be won in bought games.

CHANCE SPIN FEATURE



Any 1 or more appearing in a bought game trigger the CHANCE SPIN FEATURE.
 Any / appearing in the bought game that trigger the CHANCE SPIN FEATURE are held in position until the CHANCE SPIN FEATURE or WIN COLLECTOR ends.
 When the CHANCE SPIN FEATURE is triggered, 3 free spins are awarded.
 Each newly appearing / in a free spin resets the number of remaining free spins to 3 and is held in position until the CHANCE SPIN FEATURE or the WIN COLLECTOR ends.
 When the WIN COLLECTOR ends, any 1 or more held on the reels trigger the CHANCE SPIN FEATURE again and are held in position until the CHANCE SPIN FEATURE or WIN COLLECTOR ends.
 Any held on the reels are removed before the retriggered CHANCE SPIN FEATURE starts.

WIN COLLECTOR



Any combination of 6 or more / appearing in a bought game or the CHANCE SPIN FEATURE trigger the WIN COLLECTOR and are held in position for the duration of the WIN COLLECTOR.
 When the WIN COLLECTOR is triggered, 3 free spins are awarded.
 Each newly appearing in a free spin resets the number of remaining free spins to 3 and is held in position until the WIN COLLECTOR ends. WIN COLLECTOR ends after all awarded free spins have been played or if / appear in all 15 symbol positions.

JACKPOTS AND BONUSES



There is a chance that 1 of the following prizes is randomly won in bought games except when the CHANCE SPIN FEATURE or WIN COLLECTOR is triggered.

- GRAND JACKPOT
- MAJOR JACKPOT



TYPE OF FEATURES

Free Game + LP

REEL CONFIGURATION

5-Reel 3-Row Video Slot

PAYLINES

10, 20, 25, 30, 50 Lines
 (Denomination 1, 2, 3, 4)
 1, 5, 10, 15, 25 Lines (Denomination 4)
 1, 2, 3, 4, 5 Lines (Denomination 4, 5, 6)

DENOMINATIONS

1	2	3	4	5	6
1c	2c	5c	10c	\$1	\$2
5c	10c	25c	50c	\$5	\$10
10c	20c	50c	\$1	\$10	\$20
50c	\$1	\$2.50	\$5	\$50	\$100
\$1	\$2	\$5	\$10	\$100	\$200

BET CONFIGURATIONS

1, 2, 3, 4, 5
 1, 2, 3, 5, 8
 1, 2, 3, 5, 10

MAX BET

250, 400, 500 (Denomination 1, 2, 3, 4)
 125, 200, 250 (Denomination 4)
 25, 40, 50 (Denomination 4, 5, 6)



Successive chains of prize collecting features award dazzling treasure. Especially-persistent bonus symbols trigger free spins in which there is a greater chance to trigger a prize collection feature. After completing any prize collection feature, the especially-persistent bonus symbols trigger more free spins in which there is a greater chance to trigger the prize collection feature again. All credit prizes and jackpots on the held bonus symbols at the end of the prize collection feature are won. Additionally, mystery bonuses and jackpots can be won in bought games.

CHANCE SPIN FEATURE



Any 1 or more appearing in a bought game trigger the CHANCE SPIN FEATURE.

Any / appearing in the bought game that trigger the CHANCE SPIN FEATURE are held in position until the CHANCE SPIN FEATURE or COLLECT FEATURE ends.

When the CHANCE SPIN FEATURE is triggered, 3 free spins are awarded.

Each newly appearing / in a free spin resets the number of remaining free spins to 3 and is held in position until the CHANCE SPIN FEATURE or COLLECT FEATURE ends.

When the COLLECT FEATURE ends, any 1 or more held on the reels trigger the CHANCE SPIN FEATURE again and are held in position until the CHANCE SPIN FEATURE or COLLECT FEATURE ends.

Any held on the reels are removed before the retriggered CHANCE SPIN FEATURE starts.

COLLECT FEATURE



Any combination of 6 or more / appearing in a bought game or the CHANCE SPIN FEATURE trigger the COLLECT FEATURE and are held in position for the duration of the COLLECT FEATURE.

When the COLLECT FEATURE is triggered, 3 free spins are awarded.

Each newly appearing in a free spin resets the number of remaining free spins to 3 and is held in position until the COLLECT FEATURE ends. COLLECT FEATURE ends after all awarded free spins have been played or if / appear in all 15 symbol positions.

JACKPOTS AND BONUSES



There is a chance that 1 of the following prizes is randomly won in bought games except when the CHANCE SPIN FEATURE or COLLECT FEATURE is triggered.

- GRAND JACKPOT
- MAJOR JACKPOT

TYPE OF FEATURES

Free Game + LP

REEL CONFIGURATION

5-Reel 3-Row Video Slot

PAYLINES

10, 20, 25, 30, 50 Lines

(Denomination 1, 2, 3, 4)

1, 5, 10, 15, 25 Lines (Denomination 4)

1, 2, 3, 4, 5 Lines (Denomination 4, 5, 6)

DENOMINATIONS

1	2	3	4	5	6
1c	2c	5c	10c	\$1	\$2
5c	10c	25c	50c	\$5	\$10
10c	20c	50c	\$1	\$10	\$20
50c	\$1	\$2.50	\$5	\$50	\$100
\$1	\$2	\$5	\$10	\$100	\$200

BET CONFIGURATIONS

1, 2, 3, 4, 5

1, 2, 3, 5, 8

1, 2, 3, 5, 10

MAX BET

250, 400, 500 (Denomination 1, 2, 3, 4)

125, 200, 250 (Denomination 4)

25, 40, 50 (Denomination 4, 5, 6)

FORTUNE FRAME™

DRAGON BOUNTY

FORTUNE FRAME™

PANDA CARNIVAL

FORTUNE FRAME™
GRAND JACKPOT
\$10,000.01
MAJOR JACKPOT
\$501.95

FORTUNE FRAME™
GRAND JACKPOT
\$10,000.03
MAJOR JACKPOT
\$500.59

MINOR BONUS **\$25.00** MINI BONUS **\$10.00**

 A bonus game screen for Dragon Bounty featuring a golden treasure chest overflowing with coins and gems. The background is a vibrant red and gold pattern. Text at the bottom includes "DRAGON BOUNTY" and "RANDOM WILD IN FREE GAMES".

MINOR BONUS **\$25.00** MINI BONUS **\$10.00**

 A bonus game screen for Panda Carnival featuring a golden treasure chest overflowing with coins and gems. The background is a vibrant red and gold pattern. Text at the bottom includes "PANDA CARNIVAL" and "RANDOM WILD IN FREE GAMES".

ANY 3 OF WILD THUNDER CAN BEYOND FEARSOME



 The main game screen for Dragon Bounty, a 5x3 slot machine. Symbols include dragons, treasure chests, and various fruits. A "FREE GAME" and "WILD" symbol are visible. The bottom status bar shows "CREDIT 2000", "BET 88", and "WIN 0".

ANY 3 OF WILD THUNDER CAN BEYOND FEARSOME

 The main game screen for Panda Carnival, a 5x3 slot machine. Symbols include pandas, treasure chests, and various fruits. A "FREE GAME" and "WILD" symbol are visible. The bottom status bar shows "CREDIT 2000", "BET 440", and "WIN 0".

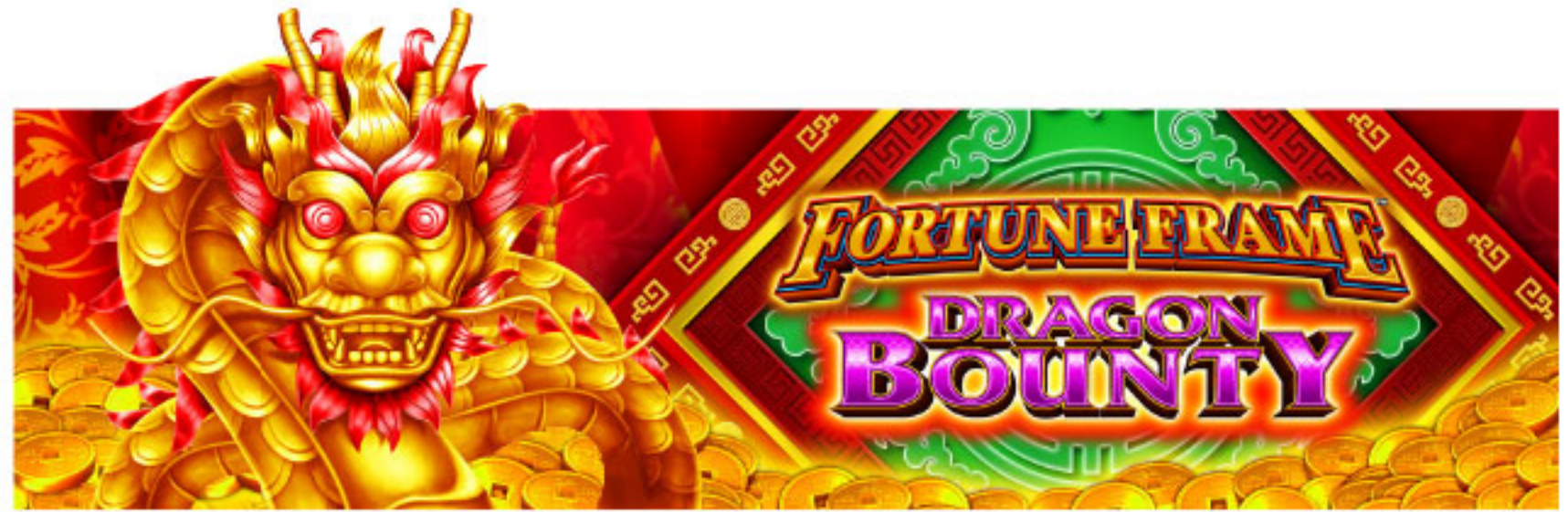



Collect more  for more prizes. Random  appearing in any symbol position boost your excitement. In Cash Spin, each spin awards prizes or an additional +1 spin. In Free Games, WILD randomly appear, becoming a multiplier and granting even bigger wins. GRAND JACKPOT or MAJOR JACKPOT can also be randomly won in bought games.



CASH SPIN



Any 6 or more  in a bought game trigger the CASH SPIN FEATURE.

When the CASH SPIN FEATURE is triggered, 5 free spins are awarded.

All  appearing in the game that triggers the CASH SPIN FEATURE become  that are held in position on the reels for the duration of the CASH SPIN FEATURE.

There is a chance in each free spin that 1  is added to a random symbol position that does not already contain a held  and is held in position until the CASH SPIN FEATURE ends.

Each spin, any prize appearing within a  is won.

CASH SPIN FEATURE starts after the FREE GAMES FEATURE ends if triggered in the same bought game.

CASH SPIN FEATURE ends after all awarded free spins have been played.

All  are removed when the CASH SPIN FEATURE ends.

TYPE OF FEATURES

Free Game + LP

REEL CONFIGURATION

5-Reel 3-Row Video Slot

PAYLINES

243 Ways

DENOMINATIONS

1	2	3	4	5	6
1c	2c	5c	10c	\$1	\$2
2c	5c	10c	20c	50c	\$1
5c	10c	20c	50c	\$1	\$2
5c	10c	20c	50c	\$1	\$10
10c	20c	50c	\$1	\$2	\$5
20c	50c	\$1	\$2	\$5	\$10
50c	\$1	\$2	\$5	\$10	\$20
\$1	\$2	\$5	\$10	\$20	\$50
\$2	\$5	\$10	\$20	\$100	\$200
\$10	\$20	\$50	\$100	\$500	\$1000

BET CONFIGURATIONS

- 1, 2, 3, 4, 5
- 1, 2, 3, 4, 6
- 1, 2, 3, 5, 10
- 1, 2, 3, 6, 10
- 1, 2, 5, 10, 20

MIN/MAX BET



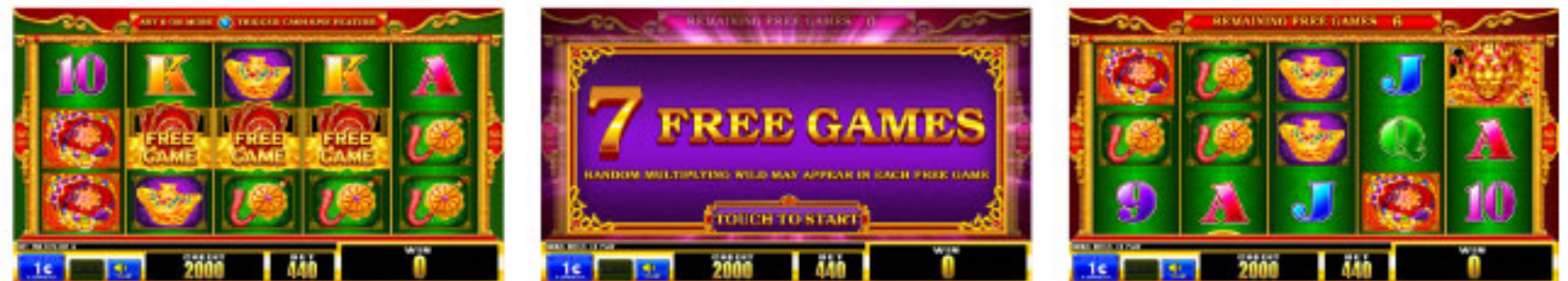

8 Bet up to 1760 Bet

(Depends on the above Bet Configurations)

FREE GAMES



Any 3  appearing on reels 2, 3 and 4 trigger the FREE GAMES FEATURE with 7 free games.

In each free game, there is a chance that one or more symbol positions randomly become     or .

The sum of multipliers from every  /  /  /  that substitutes in a win multiplies the pay for that win.

Any  appearing in the same position as  /  /  /  /  is valid and displayed alternately if part of scatter win.

During the FREE GAMES FEATURE, any 3  appearing on reels 2, 3 and 4 awards 5 additional free games.

JACKPOT SURPRISE



There is a chance that 1 of the following prizes is randomly won in bought games except when FREE GAMES FEATURE or CASH SPIN FEATURE is triggered.

- GRAND JACKPOT
- MAJOR JACKPOT



Collect more for more prizes. Random appearing in any symbol position boost your excitement. In Cash Spin, each spin awards prizes or an additional +1 spin. In Free Games, extra WILD appear granting even bigger wins. GRAND JACKPOT or MAJOR JACKPOT can also be randomly won in bought games.

CASH SPIN



Any 6 or more in a bought game trigger the CASH SPIN FEATURE.
 When the CASH SPIN FEATURE is triggered, 5 free spins are awarded.
 All appearing in the game that triggers the CASH SPIN FEATURE become that are held in position on the reels for the duration of the CASH SPIN FEATURE.
 There is a chance in each free spin that 1 is added to a random symbol position that does not already contain a held and is held in position until the CASH SPIN FEATURE ends.
 Each spin, any prize appearing within a is won.
 CASH SPIN FEATURE starts after the FREE GAMES FEATURE ends if triggered in the same bought game.
 CASH SPIN FEATURE ends after all awarded free spins have been played.
 All are removed when the CASH SPIN FEATURE ends.

FREE GAMES

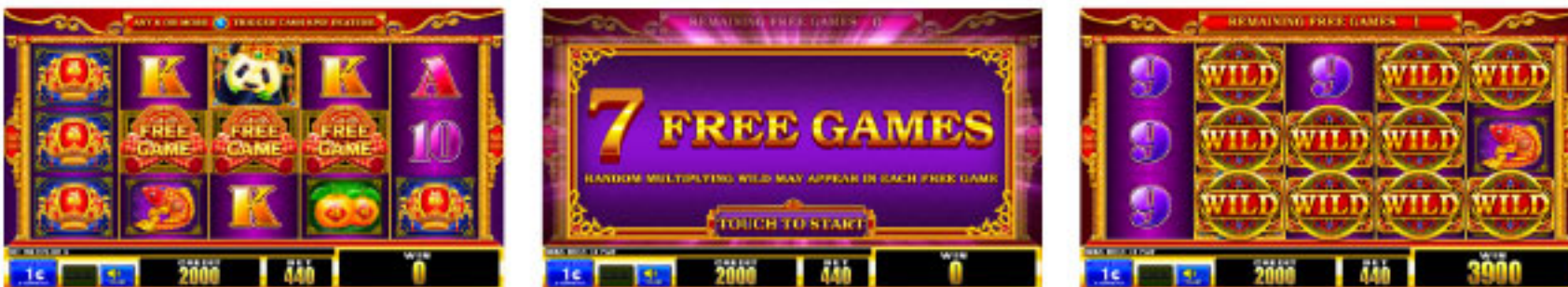

Any 3 appearing on reels 2, 3 and 4 trigger the FREE GAMES FEATURE with 7 free games.
 In each free game, there is a chance that one or more symbol positions randomly become .
 Any appearing in the same position as is valid and displayed alternately if part of scatter win.
 During the FREE GAMES FEATURE, any 3 appearing on reels 2, 3 and 4 awards 5 additional free games.

JACKPOT SURPRISE



There is a chance that 1 of the following prizes is randomly won in bought games except when FREE GAMES FEATURE or CASH SPIN FEATURE is triggered.

- GRAND JACKPOT
- MAJOR JACKPOT



TYPE OF FEATURES

Free Game + LP

REEL CONFIGURATION

5-Reel 3-Row Video Slot

PAYLINES

243 Ways

DENOMINATIONS

1	2	3	4	5	6
1c	2c	5c	10c	\$1	\$2
2c	5c	10c	20c	50c	\$1
5c	10c	20c	50c	\$1	\$2
5c	10c	20c	50c	\$1	\$10
10c	20c	50c	\$1	\$2	\$5
20c	50c	\$1	\$2	\$5	\$10
50c	\$1	\$2	\$5	\$10	\$20
\$1	\$2	\$5	\$10	\$20	\$50
\$2	\$5	\$10	\$20	\$100	\$200
\$10	\$20	\$50	\$100	\$500	\$1000

BET CONFIGURATIONS

1, 2, 3, 4, 5

1, 2, 3, 4, 6

1, 2, 3, 5, 10

1, 2, 3, 6, 10

1, 2, 5, 10, 20

MIN/MAX BET

8 Bet up to 1760 Bet

(Depends on the above Bet Configurations)

DANCING PANDA SUPREME FESTIVAL

DANCING PANDA SUPREME FORTUNE





Happy blessings come from wild surprises. During free games, multiple symbol kinds on all reels may randomly become wild symbols and line wins may be multiplied by randomly appearing multiplier wild symbols. The all-new FUSION FEATURE may award multipliers on bonus symbols making all prizes be multiplied for extravagant amount of prizes.

FREE GAMES FEATURE



Any 3 or more trigger the FREE GAMES. FREE GAMES consist of 8 FREE GAMES. During FREE GAMES, any 3 or more award 5 additional free games. FREE GAMES start after the FUSION FEATURE ends if triggered in the same game. If the FUSION FEATURE is triggered during the FREE GAMES, any remaining free games resume after the FUSION FEATURE ends.

FUSION FEATURE



Any 6 or more in a bought game or a FREE GAME trigger the FUSION FEATURE. When the FUSION FEATURE is triggered, 3 free spins are awarded. Any appearing in the game that triggers the FUSION FEATURE become in the FUSION FEATURE. Any symbol position or FUSION FEATURE REEL PATTERN during the FUSION FEATURE are held in position on the reels for the duration of the FUSION FEATURE. During the FUSION FEATURE free spins, each symbol position or FUSION FEATURE REEL PATTERN formed becomes an individual bonus reel. Any newly appearing in the FUSION FEATURE resets the number of remaining free spins to 3. FUSION FEATURE ends after all awarded free spins have been played or if all symbol positions are filled with / / .

JACKPOT SURPRISE



There is a chance that GRAND JACKPOT is randomly won in any bought game, except in the game that FUSION FEATURE is triggered.



TYPE OF FEATURES

Free Game + LP

REEL CONFIGURATION

5-Reel 3-Row Video Slot

PAYLINES

10, 20, 25, 30, 50 Lines (Denomination 1, 2)
5, 10, 15, 20, 25 Lines (Denomination 3, 4, 5)
1, 2, 3, 4, 5 Lines (Denomination 6, 7)

DENOMINATIONS

1	2	3	4	5	6	7
1c	2c	5c	10c	20c	\$1	\$2
5c	10c	25c	50c	\$1	\$5	\$10
10c	20c	50c	\$1	\$2	\$10	\$20
50c	\$1	\$2.50	\$5	\$10	\$50	\$100
\$1	\$2	\$5	\$10	\$20	\$100	\$200

BET CONFIGURATIONS

1, 2, 3, 4, 5
1, 2, 3, 5, 8
1, 2, 3, 5, 10
1, 2, 5, 10, 20

MAX BET

250, 400, 500, 1000 (Denomination 1, 2)
125, 200, 250, 500 (Denomination 3, 4, 5)
25, 40, 50, 100 (Denomination 6, 7)



Happy blessings come from wild surprises. During free games, multiple symbol kinds on all reels may randomly become wild symbols and line wins may be multiplied by randomly appearing multiplier wild symbols. The all-new FUSION FEATURE may award multipliers on bonus symbols making all prizes be multiplied for extravagant amount of prizes.

FREE GAMES FEATURE



Any 3 or more  trigger the FREE GAMES in bought games only.

FREE GAMES consist of 7 FREE GAMES.

During FREE GAMES, each  awards 1, 2 or 3 additional free games, randomly.

FREE GAMES cannot be triggered again during the FREE GAMES.

FREE GAMES start after the FUSION FEATURE ends if triggered in the same game.

If the FUSION FEATURE is triggered during the FREE GAMES, any remaining free games resume after the FUSION FEATURE ends.

FUSION FEATURE



Any 6 or more  in a bought game or a FREE GAME trigger the FUSION FEATURE.



When the FUSION FEATURE is triggered, 3 free spins are awarded.

Any  appearing in the game that triggers the FUSION FEATURE become  in the FUSION FEATURE.

Any  symbol position or FUSION FEATURE REEL PATTERN during the FUSION FEATURE are held in position on the reels for the duration of the FUSION FEATURE.

During the FUSION FEATURE free spins, each symbol position or FUSION FEATURE REEL PATTERN formed becomes an individual bonus reel.

Any newly appearing  in the FUSION FEATURE resets the number of remaining free spins to 3.

FUSION FEATURE ends after all awarded free spins have been played or if all symbol positions are filled with  /  / .

JACKPOT SURPRISE



There is a chance that GRAND JACKPOT is randomly won in any bought game, except in the game that FUSION FEATURE is triggered.

TYPE OF FEATURES

Free Game + LP

REEL CONFIGURATION

5-Reel 3-Row Video Slot

PAYLINES

10, 20, 25, 30, 50 Lines (Denomination 1, 2)

5, 10, 15, 20, 25 Lines (Denomination 3, 4, 5)

1, 2, 3, 4, 5 Lines (Denomination 6, 7)

DENOMINATIONS

1	2	3	4	5	6	7
1c	2c	5c	10c	20c	\$1	\$2
5c	10c	25c	50c	\$1	\$5	\$10
10c	20c	50c	\$1	\$2	\$10	\$20
50c	\$1	\$2.50	\$5	\$10	\$50	\$100
\$1	\$2	\$5	\$10	\$20	\$100	\$200

BET CONFIGURATIONS

1, 2, 3, 4, 5

1, 2, 3, 5, 8

1, 2, 3, 5, 10

1, 2, 5, 10, 20

MAX BET

250, 400, 500, 1000 (Denomination 1, 2)

125, 200, 250, 500 (Denomination 3, 4, 5)

25, 40, 50, 100 (Denomination 6, 7)

TOMB TREASURE™





Dare to explore the hidden riches of lore. Win all prizes shown on collected bonus symbols and get extra free spins in any spin of the collect feature in which a new bonus symbol appears. Prizes on bonus symbols are determined by a changing prize map that mirrors the reels with each new bonus symbol displaying the sum of all prizes collected in previous spins. Grand Jackpot is won when 15 bonus symbols are collected or it is won randomly in bought games. Free games use reels with extra wild symbols.

FREE GAMES FEATURE



Any 3 appearing on reels 2, 3 and 4 trigger the FREE GAMES FEATURE with 8 free games.

Reels used during the FREE GAMES FEATURE contain a greater total number of .

FREE GAMES FEATURE can be triggered again during the FREE GAMES FEATURE.

FREE GAMES FEATURE starts after the PYRAMID FEATURE ends if triggered in the same game.

If PYRAMID FEATURE is triggered during the FREE GAMES FEATURE, any remaining free games resume after the PYRAMID FEATURE ends.

PYRAMID FEATURE



Any 6 or more trigger the PYRAMID FEATURE and are held in position on the reels for the duration of the PYRAMID FEATURE. PYRAMID FEATURE consists of 3 free spins.

During the PYRAMID FEATURE, each symbol position that does not contain a held becomes an individual spinning bonus reel.

In the PYRAMID FEATURE, a prize map corresponding to the 15 symbol positions on the reels is displayed above the reels.

While a is held on the reels, the prize in the corresponding location on the prize map is also held.

Before the first free spin, each held on the reels displays the prize from the corresponding location on the prize map.

Each new appearing in a free spin resets the number of remaining free spins to 3 and is held in position for the duration of the PYRAMID FEATURE.

PYRAMID FEATURE ends after all awarded free spins have been played or if appear in all 15 symbol positions.

MYSTERY PRIZE



There is a chance that the GRAND JACKPOT is randomly won in bought games except when FREE GAMES FEATURE or PYRAMID FEATURE is triggered.

The contribution amount that exceeds the jackpot upper limit is added to the next JACKPOT.

TYPE OF FEATURES

Free Game + LP

REEL CONFIGURATION

5-Reel 3-Row Video Slot

PAYLINES

50 Lines (1c, 2c)

25 Lines (5c, 10c)

5 Lines (\$1)

DENOMINATIONS

1c, 2c, 5c, 10c, \$1

(True Multi-Denomination Available)

CASINOS

BET BUTTONS	MAX BET	CREDIT
1, 2, 5, 10	50	\$1
1, 2, 3, 4, 5	25	
1, 2, 3, 5, 8	40	
1, 2, 3, 5, 10	50	
1, 2, 3, 4, 5	125	5c, 10c
1, 2, 3, 5, 8	200	
1, 2, 3, 5, 10	250	
1, 2, 5, 10, 20	500	
1, 2, 3, 4, 5	250	1c, 2c
1, 2, 3, 5, 8	400	
1, 2, 3, 5, 10	500	
1, 2, 5, 10, 20	1000	

CLUBS & HOTELS

BET BUTTONS	MAX BET	CREDIT
1	5	\$1
1, 2	50	10c
1, 2, 3	75	5c
1, 2, 3, 4	100	2c
1, 2, 3, 5	250	1c, 2c
1, 2, 3, 4, 5	250	1c
1, 2, 3, 5, 8	400	
1, 2, 3, 5, 10	500	



Dare to explore the hidden riches of lore. Win all prizes shown on collected bonus symbols and get extra free spins in any spin of the collect feature in which a new bonus symbol appears. Prizes on bonus symbols are determined by a changing prize map that mirrors the reels with each new bonus symbol displaying the sum of all prizes collected in previous spins. Grand Jackpot is won when 15 bonus symbols are collected or it is won randomly in bought games. Free games use reels with extra bonus symbols.

FREE GAMES FEATURE



Any 3 appearing on reels 2, 3 and 4 trigger the FREE GAMES FEATURE with 6 free games. Reels used during the FREE GAMES FEATURE contain a greater total number of . FREE GAMES FEATURE can be triggered again during the FREE GAMES FEATURE. FREE GAMES FEATURE starts after the PYRAMID FEATURE ends if triggered in the same game. If PYRAMID FEATURE is triggered during the FREE GAMES FEATURE, any remaining free games resume after the PYRAMID FEATURE ends.

PYRAMID FEATURE



Any 6 or more trigger the PYRAMID FEATURE and are held in position on the reels for the duration of the PYRAMID FEATURE. PYRAMID FEATURE consists of 3 free spins. During the PYRAMID FEATURE, each symbol position that does not contain a held becomes an individual spinning bonus reel. In the PYRAMID FEATURE, a prize map corresponding to the 15 symbol positions on the reels is displayed above the reels. While a is held on the reels, the prize in the corresponding location on the prize map is also held. Before the first free spin, each held on the reels displays the prize from the corresponding location on the prize map. Each new appearing in a free spin resets the number of remaining free spins to 3 and is held in position for the duration of the PYRAMID FEATURE. PYRAMID FEATURE ends after all awarded free spins have been played or if appear in all 15 symbol positions.

MYSTERY PRIZE



There is a chance that the GRAND JACKPOT is randomly won in bought games except when FREE GAMES FEATURE or PYRAMID FEATURE is triggered. The contribution amount that exceeds the jackpot upper limit is added to the next JACKPOT.



TYPE OF FEATURES

Free Game + LP

REEL CONFIGURATION

5-Reel 3-Row Video Slot

PAYLINES

50 Lines (1c, 2c)

25 Lines (5c, 10c)

5 Lines (\$1)

DENOMINATIONS

1c, 2c, 5c, 10c, \$1

(True Multi-Denomination Available)

CASINOS

BET BUTTONS	MAX BET	CREDIT
1, 2, 5, 10	50	\$1
1, 2, 3, 4, 5	25	
1, 2, 3, 5, 8	40	
1, 2, 3, 5, 10	50	5c, 10c
1, 2, 3, 4, 5	125	
1, 2, 3, 5, 8	200	
1, 2, 3, 5, 10	250	1c, 2c
1, 2, 5, 10, 20	500	
1, 2, 3, 4, 5	250	
1, 2, 3, 5, 8	400	
1, 2, 3, 5, 10	500	1c
1, 2, 5, 10, 20	1000	

CLUBS & HOTELS

BET BUTTONS	MAX BET	CREDIT
1	5	\$1
1, 2	50	10c
1, 2, 3	75	5c
1, 2, 3, 4	100	2c
1, 2, 3, 5	250	1c, 2c
1, 2, 3, 4, 5	250	1c, 2c
1, 2, 3, 5, 8	400	1c
1, 2, 3, 5, 10	500	1c



Dare to explore the hidden riches of lore. Win all prizes shown on collected bonus symbols and get extra free spins in any spin of the collect feature in which a new bonus symbol appears. Prizes on bonus symbols are determined by a changing prize map that mirrors the reels with each new bonus symbol displaying the sum of all prizes collected in previous spins. Grand Jackpot is won when 15 bonus symbols are collected or it is won randomly in bought games. Free games use reels with extra wild symbols.

FREE GAMES FEATURE

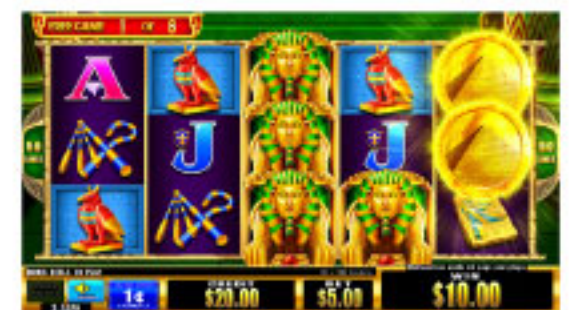

Any 3  appearing on reels 2, 3 and 4 trigger the FREE GAMES FEATURE with 8 free games.

Reels used during the FREE GAMES FEATURE contain a greater total number of .

FREE GAMES FEATURE can be triggered again during the FREE GAMES FEATURE.

FREE GAMES FEATURE starts after the PYRAMID FEATURE ends if triggered in the same game.

If PYRAMID FEATURE is triggered during the FREE GAMES FEATURE, any remaining free games resume after the PYRAMID FEATURE ends.

PYRAMID FEATURE

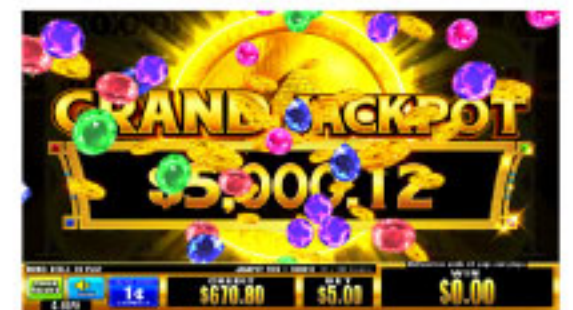



Any 6 or more  trigger the PYRAMID FEATURE and are held in position on the reels for the duration of the PYRAMID FEATURE. PYRAMID FEATURE consists of 3 free spins.

During the PYRAMID FEATURE, each symbol position that does not contain a held  becomes an individual spinning bonus reel.

In the PYRAMID FEATURE, a prize map corresponding to the 15 symbol positions on the reels is displayed above the reels.

While a  is held on the reels, the prize in the corresponding location on the prize map is also held.

Before the first free spin, each held  on the reels displays the prize from the corresponding location on the prize map.

Each new  appearing in a free spin resets the number of remaining free spins to 3 and is held in position for the duration of the PYRAMID FEATURE.

PYRAMID FEATURE ends after all awarded free spins have been played or if  appear in all 15 symbol positions.

MYSTERY PRIZE



There is a chance that the GRAND JACKPOT is randomly won in bought games except when FREE GAMES FEATURE or PYRAMID FEATURE is triggered.

The contribution amount that exceeds the jackpot upper limit is added to the next JACKPOT.

TYPE OF FEATURES

Free Game + LP

REEL CONFIGURATION

5-Reel 3-Row Video Slot

PAYLINES

50 Lines (1c, 2c)

25 Lines (5c, 10c)

5 Lines (\$1)

DENOMINATIONS

1c, 2c, 5c, 10c, \$1

(True Multi-Denomination Available)

CASINOS

BET BUTTONS	MAX BET	CREDIT
1, 2, 5, 10	50	\$1
1, 2, 3, 4, 5	25	
1, 2, 3, 5, 8	40	
1, 2, 3, 5, 10	50	
1, 2, 3, 4, 5	125	5c, 10c
1, 2, 3, 5, 8	200	
1, 2, 3, 5, 10	250	
1, 2, 5, 10, 20	500	1c, 2c
1, 2, 3, 4, 5	250	
1, 2, 3, 5, 8	400	
1, 2, 3, 5, 10	500	
1, 2, 5, 10, 20	1000	

CLUBS & HOTELS

BET BUTTONS	MAX BET	CREDIT
1	5	\$1
1, 2	50	10c
1, 2, 3	75	5c
1, 2, 3, 4	100	2c
1, 2, 3, 5	250	1c, 2c
1, 2, 3, 4, 5	250	1c
1, 2, 3, 5, 8	400	
1, 2, 3, 5, 10	500	

HYPER Speed

CABINET FEATURE

- Ultra High Definition 43" Monitor
- Premium Speed LCD Touch Screen button panel with Bash Button
- USB Charging Port & Wireless Charger
- Dual Logic PC Capability
- Immersive Audio & Visual Experience
- 27" Topper Available
- Optimal service design for accessibility and maintenance

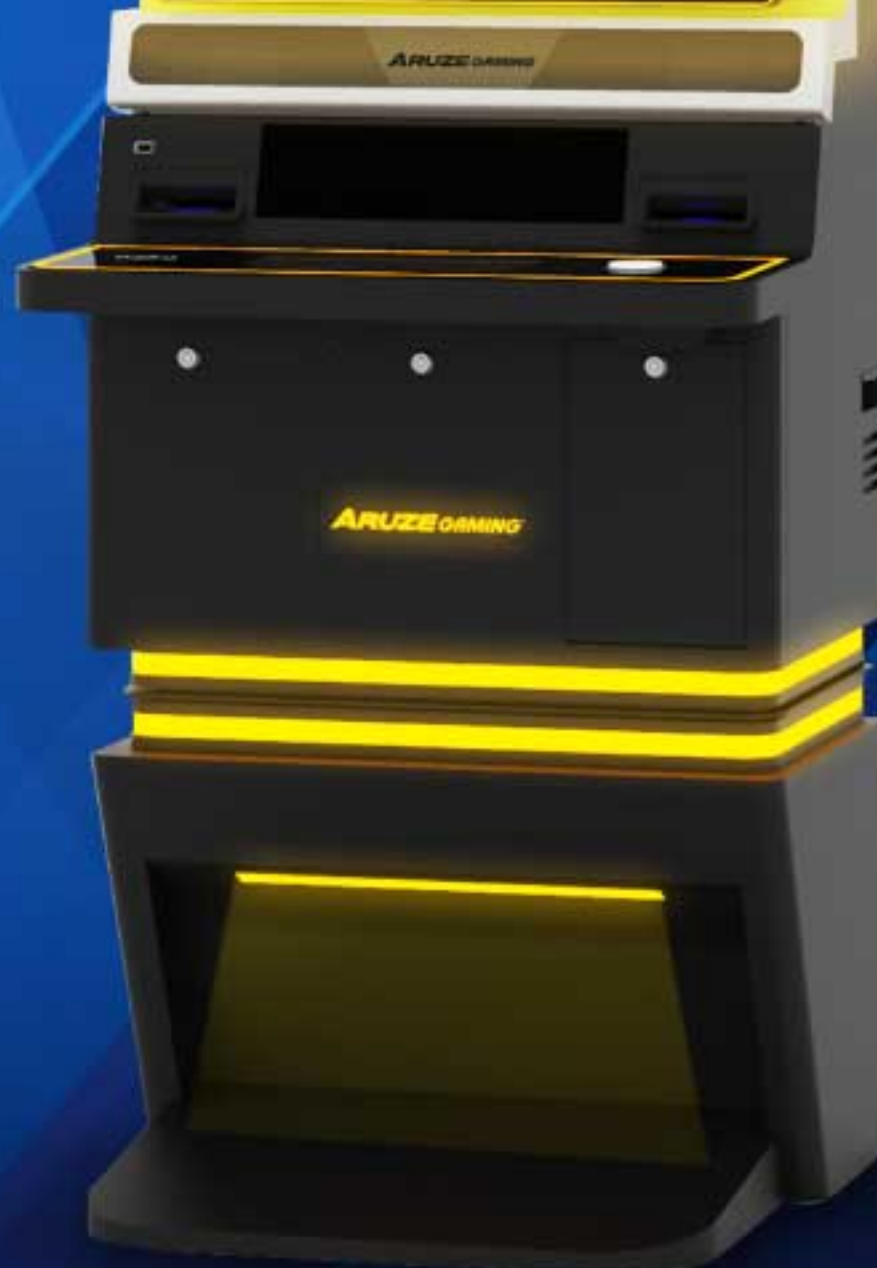

VIDEO GAMING MACHINE™

CABINET SPECIFICATION

DIMENSIONS	
Depth	27.38"
Width	26.77"
Height	74.51"
Height (Tower Light Included)	79.95"

FU JIN SHU™

赋金树

GRAND
\$8,800.70

MAJOR
\$801.06

MINOR \$26.41 MINI \$12.83

GRAND
\$8,800.74

MAJOR
\$801.11

MINOR \$20.48 MINI \$12.96

FU JIN SHU™

赋金树

DRAGON

UP TO 4 EXTRA SYMBOL ROWS

REELS

EXTRA WILD (POST CARD)

WILD

1c 1412 88 0

FU JIN SHU™

赋金树

PHOENIX

UP TO 4 EXTRA SYMBOL ROWS

REELS

EXTRA WILD (POST CARD)

WILD

1c 1412 88 0

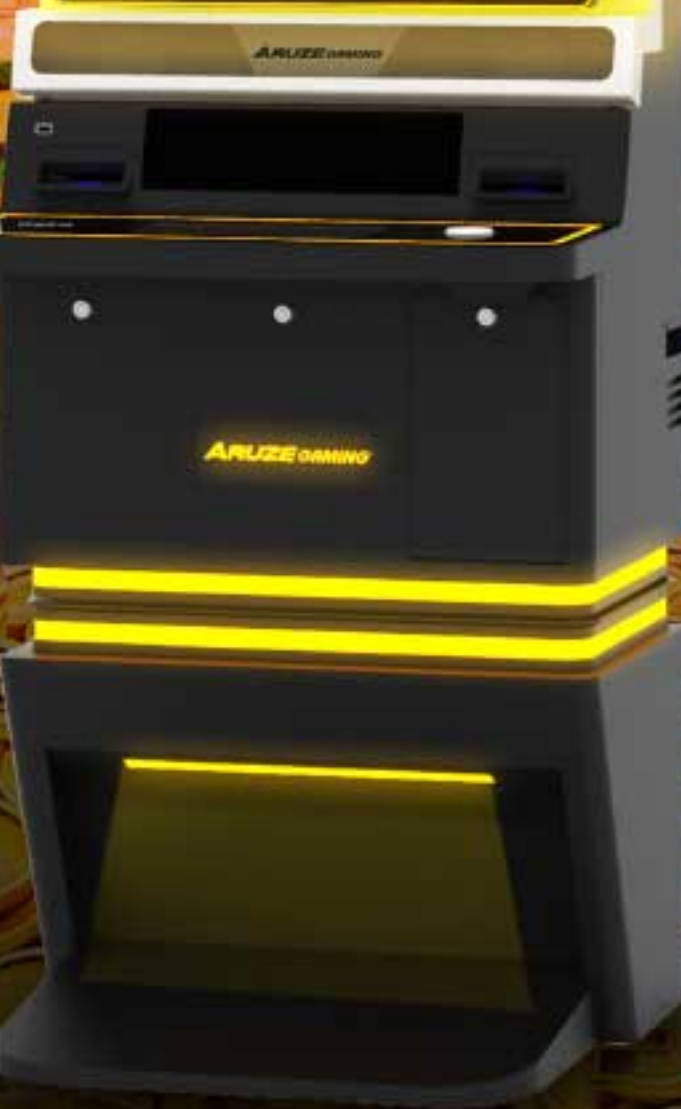



Thousands of coins flowering on the tree that sources jackpot wins. During bought games, the reels expand up to 4 extra symbol rows when bonus symbol appears on reels 2 and 3. Increased chance of big wins with wild symbol during the Wild Hold Spins. During each free game, the reels randomly expand up to 4 extra symbol rows and WILD may appear randomly across the reels. Jackpot Feature may be randomly triggered in bought games. Additionally, a mystery credit prize may be randomly won in bought games.

EXPANDER REELS

During bought games, 2 scattered appearing on reels 2 and 3 trigger EXPANDER REELS. During free games, EXPANDER REELS are randomly triggered. In the spin that EXPANDER REELS are triggered, all reels are expanded upward 1, 2, 3 or 4 rows of symbols, randomly.



FREE GAMES

3 scattered appearing on reels 1, 3 and 5 trigger 7 free games. Different reels are used during the free games.

EXTRA WILD

If EXPANDER REELS are triggered in a free game, there is a chance that one or more symbol positions randomly become for that game. All wins determined after the completion of symbol changes has occurred. The sum of multipliers from every that substitutes in a win multiplies the pay for that win. Free games start after the JACKPOT FEATURE ends if triggered in the same bought game.

WILD HOLD SPINS

3 scattered appearing on reels 2, 3 and 4 trigger 6 free spins of overlaying reels containing while the reels of the bought game are held. All payable wins for the bought game are determined after the last free spin. When a stops on a symbol position, that symbol position becomes a substitute symbol as described below and is held in position until all wins for the bought game are determined after the last free spin. No wins for any combination during the free spins.



- : If stops on any symbol position.
- : If stops on a symbol position that became .
- : If stops on a symbol position that became .
- : If stops on a symbol position that became .
- : If stops on a symbol position that became .
- : If stops on a symbol position that became .

The sum of multipliers from every that substitutes in a win multiplies the pay for that win. The row height of the overlay reels used during the free spins are the same as the row height of the reels used in the game that

triggered the free spins. WILD HOLD SPINS start after the JACKPOT FEATURE ends if triggered in the same bought game.



JACKPOT FEATURE

There is a chance that the JACKPOT FEATURE may be triggered when 1 or more appear on reels 2, 3 or 4 in bought games only. on any reel in a bought game that is a result of WILD HOLD SPINS does not offer a chance to trigger the JACKPOT FEATURE. In the JACKPOT FEATURE, there are 4 types of jackpot symbols hidden behind 12 icons. Select an icon until 3 matching jackpot symbols corresponding to a JACKPOT are revealed. When 3 matching jackpot symbols have been revealed, the corresponding JACKPOT is won and the JACKPOT FEATURE ends. JACKPOT FEATURE and BONUS SURPRISE cannot be triggered in the same game.

BONUS SURPRISE

There is a chance that the BONUS SURPRISE may be triggered when 1 or more appear on reels 2, 3 or 4 in bought games only. on any reel in a bought game that is a result of WILD HOLD SPINS does not offer a chance to trigger the BONUS SURPRISE. When the BONUS SURPRISE occurs, 10000 credits multiplied by bet multiplier as displayed are awarded. BONUS SURPRISE and JACKPOT FEATURE cannot be triggered in the same game. Any BONUS SURPRISE win is added to line wins.



TYPE OF FEATURES

Free Game + LP

REEL CONFIGURATION

5-Reel 3-4-4-4-3-Row Video Slot
(EXPANDER REELS: Up to 7-8-8-8-7-Row)

PAYLINES

32 Lines (EXPANDER REELS: 80 Lines)

DENOMINATIONS

1¢

BET CONFIGURATIONS

1, 2, 3, 4, 5, 6, 7, 8, 9, 10

MIN/MAX BET

88 Bet to 880 Bet

(Depends on the above Bet Configurations)

HYPER Speed



Thousands of coins flowering on the tree that sources jackpot wins. During bought games, the reels expand up to 4 extra symbol rows when bonus symbol appears on reels 2 and 3. Increased chance of big wins with wild symbol during the Wild Hold Spins. During each free game, the reels randomly expand up to 4 extra symbol rows and all symbol positions on 1 or more reels become **WILD** or **2x**. Jackpot Feature may be randomly triggered in bought games. Additionally, a mystery credit prize may be randomly won in bought games.

EXPANDER REELS

During bought games, 2 scattered appearing on reels 2 and 3 trigger EXPANDER REELS. During free games, EXPANDER REELS are randomly triggered. In the spin that EXPANDER REELS are triggered, all reels are expanded upward 1, 2, 3 or 4 rows of symbols, randomly.



FREE GAMES

3 scattered appearing on reels 1, 3 and 5 trigger 7 free games. Different reels are used during the free games.

REELS WILD

If EXPANDER REELS are triggered in a free game, there is a chance that all symbol positions on 2 or 3 reels become either **WILD** or **2x** in that game. All wins determined after the completion of symbol changes has occurred. The sum of multipliers from every **2x** that substitutes in a win multiplies the pay for that win. Free games start after the JACKPOT FEATURE ends if triggered in the same bought game.

WILD HOLD SPINS

3 scattered appearing on reels 2, 3 and 4 trigger 6 free spins of overlaying reels containing while the reels of the bought game are held. All payable wins for the bought game are determined after the last free spin. When a stops on a symbol position, that symbol position becomes a substitute symbol as described below and is held in position until all wins for the bought game are determined after the last free spin. No wins for any combination during the free spins.



- : If stops on any symbol position.
- : If stops on a symbol position that became **WILD**.
- : If stops on a symbol position that became **2x**.
- : If stops on a symbol position that became **3x**.
- : If stops on a symbol position that became **4x**.
- : If stops on a symbol position that became **5x**.

The sum of multipliers from every **2x/3x/4x/5x/6x** that substitutes in a win multiplies the pay for that win. The row height of the overlay reels used during the free spins are the same as the row height of the reels used in the game that

triggered the free spins. WILD HOLD SPINS start after the JACKPOT FEATURE ends if triggered in the same bought game.



JACKPOT FEATURE

There is a chance that the JACKPOT FEATURE may be triggered when 1 or more **WILD** appear on reels 2, 3 or 4 in bought games only. **WILD** on any reel in a bought game that is a result of WILD HOLD SPINS does not offer a chance to trigger the JACKPOT FEATURE. In the JACKPOT FEATURE, there are 4 types of jackpot symbols hidden behind 12 icons. Select an icon until 3 matching jackpot symbols corresponding to a JACKPOT are revealed. When 3 matching jackpot symbols have been revealed, the corresponding JACKPOT is won and the JACKPOT FEATURE ends. JACKPOT FEATURE and BONUS SURPRISE cannot be triggered in the same game.

BONUS SURPRISE

There is a chance that the BONUS SURPRISE may be triggered when 1 or more **WILD** appear on reels 2, 3 or 4 in bought games only. **WILD** on any reel in a bought game that is a result of WILD HOLD SPINS does not offer a chance to trigger the BONUS SURPRISE. When the BONUS SURPRISE occurs, 10000 credits multiplied by bet multiplier as displayed are awarded. BONUS SURPRISE and JACKPOT FEATURE cannot be triggered in the same game. Any BONUS SURPRISE win is added to line wins.

TYPE OF FEATURES

Free Game + LP

REEL CONFIGURATION

5-Reel 3-4-4-4-3-Row Video Slot
(EXPANDER REELS: Up to 7-8-8-8-7-Row)

PAYLINES

32 Lines (EXPANDER REELS: 80 Lines)

DENOMINATIONS

1¢

BET CONFIGURATIONS

1, 2, 3, 4, 5, 6, 7, 8, 9, 10

MIN/MAX BET

88 Bet to 880 Bet

(Depends on the above Bet Configurations)

CAT YUN LAI™

财运来



GRAND
\$10,000.01

MAJOR
\$800.01

MINOR \$25.03 **MINI** \$10.04

財

576 WAYS TO WIN

1c 1000 88 0

GRAND
\$10,000.01

MAJOR
\$800.02

MINOR \$25.04 **MINI** \$10.06

財

UP TO 12588 WAYS TO WIN

576 WAYS TO WIN

1c 1000 88 0

GRAND
\$10,000.02

MAJOR
\$800.03

MINOR \$25.06 **MINI** \$10.09

財

RANDOM WILD

576 WAYS TO WIN

1c 1000 88 0



HYPER Speed





Wealth and luck are flowing from the pot of coins. During bought games and free games, all reels contain mystery symbol positions that randomly become the same symbol at the start of each spin. During the free games, 3 exciting free game options allow players to select the volatility of the feature. Additionally, every multiplier on WILD substituting in a win multiplies the pay for that win. JACKPOT FEATURE may be randomly triggered in bought games and free games. A mystery credit prize may also be randomly won in bought games and free games.

FREE GAMES



 appearing on 3 or more consecutive reels beginning with the leftmost reel trigger the free games. Different reels are used during the free games. Before free games start, select 1 of 3 free game options to play.



Every multiplier on  substituting in a win multiplies the pay for that win. During the free games,  appearing on 2 or more consecutive reels beginning with the leftmost reel award 3 additional free games. Free games start after the JACKPOT FEATURE ends if triggered in the same game. If JACKPOT FEATURE is triggered during free games, any remaining free games resume after JACKPOT FEATURE ends. Credits bet, GOLD PAYS and ways played during the free games are the same as the game that triggered the free games.

JACKPOT FEATURE

There is a chance that the JACKPOT FEATURE may be triggered when 1 or more  appears.



In the JACKPOT FEATURE, select from 12 icons until 3 matching symbols corresponding to a JACKPOT level are revealed.

When 3 matching JACKPOT level symbols have been revealed, the corresponding JACKPOT level is won and the JACKPOT FEATURE ends.

JACKPOT levels available according to GOLD PAYS played. The chances of revealing each jackpot symbol are not equal.

JACKPOT FEATURE and BONUS SURPRISE cannot be triggered in the same game.

BONUS SURPRISE



There is a chance that the BONUS SURPRISE may be triggered when 1 or more  appears.

When the BONUS SURPRISE occurs, 250000 credits are awarded.

BONUS SURPRISE and JACKPOT FEATURE cannot be triggered in the same game.

Any BONUS SURPRISE win is added to line wins.

TYPE OF FEATURES

Free Game + LP

REEL CONFIGURATION

5-Reel 3-4-4-4-3-Row Video Slot

PAYLINES

576 Ways

DENOMINATIONS

1¢

BET CONFIGURATIONS

1, 2, 3, 4, 5, 6, 7, 8, 9, 10

MIN/MAX BET

18 up to 880

(Depends on the above Bet Configurations)



Wealth and luck are flowing from the pot of coins. During bought games and free games, all reels contain mystery symbol positions that randomly become the same symbol at the start of each spin. During the free games, 4 exciting free game options allow players to select the volatility of the feature. JACKPOT FEATURE may be randomly triggered in bought games and free games. A mystery credit prize may also be randomly won in bought games and free games.

FREE GAMES



appearing on 3 or more consecutive reels beginning with the leftmost reel trigger the free games. Different reels are used during the free games. Before free games start, select 1 of 4 free game options to play.



During the free games, appearing on 2 or more consecutive reels beginning with the leftmost reel award 3 additional free games within the free game option being played. Free games start after the JACKPOT FEATURE ends if triggered in the same game. If JACKPOT FEATURE is triggered during free games, any remaining free games resume after JACKPOT FEATURE ends. Credits bet and GOLD PAYS played during the free games are the same as the game that triggered the free games.

JACKPOT FEATURE

There is a chance that the JACKPOT FEATURE may be triggered when 1 or more appears.



In the JACKPOT FEATURE, select from 12 icons until 3 matching symbols corresponding to a JACKPOT level are revealed.

When 3 matching JACKPOT level symbols have been revealed, the corresponding JACKPOT level is won and the JACKPOT FEATURE ends.

JACKPOT levels available according to GOLD PAYS played. The chances of revealing each jackpot symbol are not equal.

JACKPOT FEATURE and BONUS SURPRISE cannot be triggered in the same game.

BONUS SURPRISE



There is a chance that the BONUS SURPRISE may be triggered when 1 or more appears.

When the BONUS SURPRISE occurs, 250000 credits are awarded.

BONUS SURPRISE and JACKPOT FEATURE cannot be triggered in the same game.

Any BONUS SURPRISE win is added to line wins.



TYPE OF FEATURES

Free Game + LP

REEL CONFIGURATION

5-Reel 3-4-4-4-3-Row Video Slot
(Up to 6-7-7-6-Row during the free games)

PAYLINES

576 Ways

DENOMINATIONS

1¢

BET CONFIGURATIONS

1, 2, 3, 4, 5, 6, 7, 8, 9, 10

MIN/MAX BET

18 up to 880

(Depends on the above Bet Configurations)



Wealth and luck are flowing from the pot of coins. During bought games and free games, all reels contain mystery symbol positions that randomly become the same symbol at the start of each spin. During each free game, from 2 to 12 randomly determined symbol positions become WILD. JACKPOT FEATURE may be randomly triggered in bought games and free games. A mystery credit prize may also be randomly won in bought games and free games.

FREE GAMES



appearing on 3 or more consecutive reels beginning with the leftmost reel trigger 6 free games. Different reels are used during the free games. At the start of each free game, randomly determined symbol positions on 2 to 4 reels become for that free game only. The number of positions that can randomly become corresponds to the GOLD PAYS played, the number of reels that random appears on and the reel number as described below.

GOLD PAYS	RANDOM APPEARING ON TWO REELS					RANDOM APPEARING ON THREE REELS					RANDOM APPEARING ON FOUR REELS				
	1	2	3	4	5	1	2	3	4	5	1	2	3	4	5
MAX GOLD PAYS	3	4	4	4	3	2	3	3	3	3	2	3	3	3	3
GOLD PAYS 4	3	4	4	4	3	2	3	3	3	3	2	3	3	3	3
GOLD PAYS 3	2	2	2	2	3	2	3	3	3	2	2	3	3	3	3
GOLD PAYS 2	2	2	2	2	3	2	3	3	3	2	2	3	3	3	3

All wins determined on stopped reels after the completion of all symbol changes. Free games cannot be triggered again during the free games. Free games start after the JACKPOT FEATURE ends if triggered in the same bought game. If JACKPOT FEATURE is triggered during free games, any remaining free games resume after JACKPOT FEATURE ends. Credits bet, GOLD PAYS and ways played during the free games are the same as the game that triggered the free games.

JACKPOT FEATURE

There is a chance that the JACKPOT FEATURE may be triggered when 1 or more appears.



In the JACKPOT FEATURE, select from 12 icons until 3 matching symbols corresponding to a JACKPOT level are revealed.

When 3 matching JACKPOT level symbols have been revealed, the corresponding JACKPOT level is won and the JACKPOT FEATURE ends.

JACKPOT levels available according to GOLD PAYS played. The chances of revealing each jackpot symbol are not equal.

JACKPOT FEATURE and BONUS SURPRISE cannot be triggered in the same game.

BONUS SURPRISE



There is a chance that the BONUS SURPRISE may be triggered when 1 or more appears.

When the BONUS SURPRISE occurs, 250000 credits are awarded.

BONUS SURPRISE and JACKPOT FEATURE cannot be triggered in the same game.

Any BONUS SURPRISE win is added to line wins.

TYPE OF FEATURES

Free Game + LP

REEL CONFIGURATION

5-Reel 3-4-4-4-3-Row Video Slot

PAYLINES

576 Ways

DENOMINATIONS

1¢

BET CONFIGURATIONS

1, 2, 3, 4, 5, 6, 7, 8, 9, 10

MIN/MAX BET

18 up to 880

(Depends on the above Bet Configurations)

FU RU YI 福如意





Engaging and dynamic gameplay throughout with many player-customizable options. Players can choose several levels of improved reels to play. Players also choose the volatility level of free games by picking the reel type, reel format and number of free games played. Increasing the bet multiplier also exceedingly improves the size of bonus prizes in the jackpot feature consisting of five prize levels. A special wild not only triples symbol wins, it adds extra free games and triples the number of jackpot games when appearing in the triggering game of these respective features. A large mystery bonus also adds a fun surprise.

TYPE OF FEATURES

Free Game + LP

REEL CONFIGURATION

5-Reel 3-Row Video Slot

PAYLINES

243 Ways
(FREE GAMES: 1024 or 3125 or 7776 WAYS)

DENOMINATIONS

1¢

BET CONFIGURATIONS

1, 2, 3, 6, 10

MAX BET

880



IMPROVED REELS

PLAY OPTIONS	
PLAY 88 CREDITS	Reels do not contain A, K, Q and J.
PLAY 78 CREDITS	Reels do not contain K, Q and J.
PLAY 58 CREDITS	Reels do not contain Q and J.
PLAY 38 CREDITS	Reels do not contain J.
PLAY 18 CREDITS	Reels contain all symbols.

Reels contains fewer lower-paying symbols



FORTUNE BONUS

FORTUNE BONUS randomly occurs in bought games and free games.



FREE GAMES FEATURE

福 appearing on 3 or more consecutive reels beginning with the leftmost reel trigger the free games.

Select reel format and then reel type from the available free game options.

If 福 appears in the game that triggers the free games, the number of free games is increased for the free game options.

The number of free games awarded depends on the selection of reel format and the inclusion of 福, 福 and 福 on the reels.



JACKPOT FEATURE

There is a chance the JACKPOT FEATURE may be triggered when 1 or more 福 / 福 appear.

If 福 appears in the game that triggered the JACKPOT FEATURE, a total of 3 JACKPOT FEATURES are awarded and played one after the other.

Select an icon by touching it on the screen, or randomly select an icon by pressing the PLAY button.

When 3 matching symbols have been revealed, the corresponding PRIZE is won and the JACKPOT FEATURE ends.

The JACKPOT FEATURE awards the following:

- 3 JACKPOT LEVELS: GRAND, SUPER, MAJOR
- 2 BONUS PRIZES: MINOR and MINI

BONUS PRIZES INCREASED IN EXCESS OF BET MULTIPLIER

BONUS PRIZES		
ODDS: 100% REWARD IN EXCESS OF BET MULTIPLIER		
BET MULTIPLIER	MINOR	MINI
x10	\$1,000.00	\$200.00
x6	\$500.00	\$100.00
x3	\$200.00	\$40.00
x2	\$125.00	\$25.00
x1	\$50.00	\$10.00



Engaging and dynamic gameplay throughout with many player-customizable options. Players can choose several levels of improved reels to play. Players also choose the volatility level of free games by picking the multipliers, reel format and number of free games played. Increasing the bet multiplier also exceedingly improves the size of bonus prizes in the jackpot feature consisting of five prize levels. A special wild not only triples symbol wins, it adds extra free games and triples the number of jackpot games when appearing in the triggering game of these respective features. A large mystery bonus also adds a fun surprise.



IMPROVED REELS

PLAY OPTIONS	
PLAY 88 CREDITS	Reels do not contain A, K, Q and J.
PLAY 78 CREDITS	Reels do not contain K, Q and J.
PLAY 58 CREDITS	Reels do not contain Q and J.
PLAY 38 CREDITS	Reels do not contain J.
PLAY 18 CREDITS	Reels contain all symbols.

Reels contains fewer lower-paying symbols



FORTUNE BONUS

FORTUNE BONUS randomly occurs in bought games and free games.



FREE GAMES FEATURE

appearing on 3 or more consecutive reels beginning with the leftmost reel trigger the free games.

Select reel format and then max multiplier from the available free game options.

If appears in the game that triggers the free games, the number of free games is increased for the free game options.

If appears in a free game, all pays in that spin are multiplied by the multiplier displayed on .



JACKPOT FEATURE

There is a chance the JACKPOT FEATURE may be triggered when 1 or more / appear.

If appears in the game that triggered the JACKPOT FEATURE, a total of 3 JACKPOT FEATURES are awarded and played one after the other.

Select an icon by touching it on the screen, or randomly select an icon by pressing the PLAY button.

When 3 matching symbols have been revealed, the corresponding PRIZE is won and the JACKPOT FEATURE ends.

The JACKPOT FEATURE awards the following:

- 3 JACKPOT LEVELS: GRAND, SUPER, MAJOR
- 2 BONUS PRIZES: MINOR and MINI

BONUS PRIZES INCREASED IN EXCESS OF BET MULTIPLIER

BONUS PRIZES <small>BONUS PRIZES INCREASED IN EXCESS OF BET MULTIPLIER</small>		
BET MULTIPLIER	MINOR	MINI
x10	\$1,000.00	\$200.00
x6	\$500.00	\$100.00
x3	\$200.00	\$40.00
x2	\$125.00	\$25.00
x1	\$50.00	\$10.00



TYPE OF FEATURES

Free Game + LP

REEL CONFIGURATION

5-Reel 3-Row Video Slot

PAYLINES

243 Ways

(FREE GAMES: 1024 or 3125 or 7776 WAYS)

DENOMINATIONS

1¢

BET CONFIGURATIONS

1, 2, 3, 6, 10

MAX BET

880

THOR

ODIN

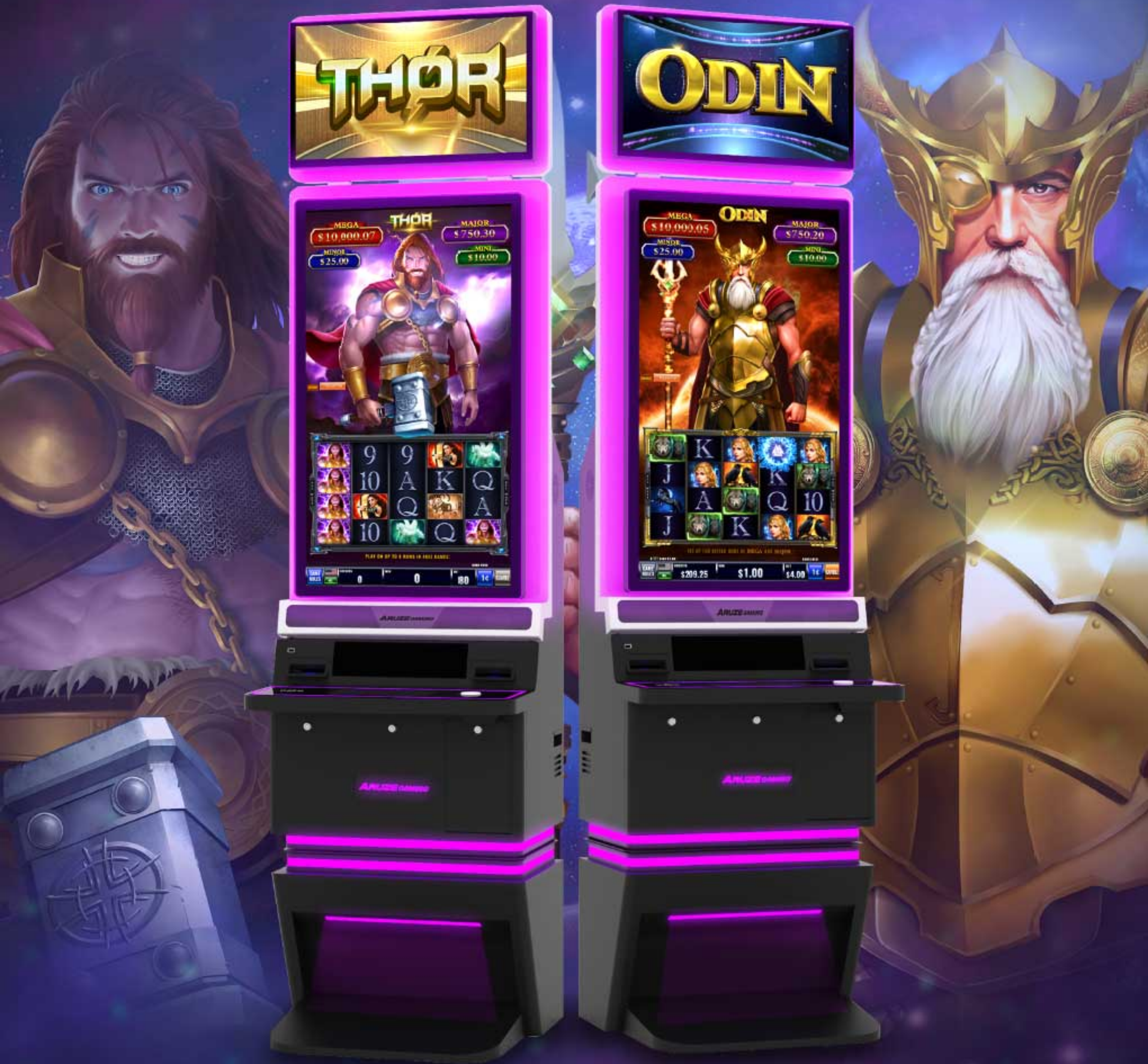



**HYPER
Speed**

Channel the power of Thor in this 5-reel game, where a player can bet more credits to increase their chance to trigger the Hammer feature during the base game, replacing all picture symbols appearing on the reels with a Hammer symbol for higher credit prize amounts!

FREE GAMES FEATURE

Three or more scattered rune symbols award the free games feature, allowing the player to spin a wheel which offers free games with up to 9 rows and 59,049 ways.



Number of free games awarded shuffles randomly based on number of scatters.



Spin the wheel to increase number of rows in play for free games, up to 9 rows.



Score a hammer symbol and all major symbols are replaced with hammer for a guaranteed Win.

During the free games feature, collect three or more scattered rune symbols to retrigger free games, or 10 thunder symbols during the free games to award the Jackpot feature.

JACKPOT FEATURE

In the Jackpot feature, the player chooses their path along the roots of Yggdrasil, the World Tree, to reach one of two bonus prizes or two levels of progressive jackpots.

Bet more to increase the odds of winning the progressive jackpots!

TYPE OF FEATURES

Free Game + Jackpot Pick, Hammer Feature

REEL CONFIGURATION

5-Reel 4-Row Video Slot

PAYLINES

Base Game 1024 Ways
Free Games 3125 - 59049 Ways

DENOMINATIONS

1¢

BET CONFIGURATIONS

1, 2, 3, 4, 5

MAX BET

400 Credits

**HYPER
Speed**



Harness the might of Odin in this 5-reel game, where a player can bet more credits to increase their odds to trigger the Spear feature during the base game, granting the player a free spin boosted with one of four options: a credit win multiplier, removed minor symbols, reels with added wilds, or even a guaranteed credit prizes!

FREE GAMES FEATURE

Three or more scattered rune symbols award the free games feature, allowing the player to choose the number of free games they wish to play, adjusting the number of rows in play during the free games!



Scoring a spear symbol grants a free spin with a choice of one of four Bonuses.



Spin the wheel after free games to multiply your winnings, or win the progressive jackpot.



Make a choice for number of rows in play in free games and the number of spins.

TYPE OF FEATURES

Free Game + Wheel, Spear Feature

REEL CONFIGURATION

5-Reel 4-Row Video Slot

PAYLINES

Base Game 1024 Ways
Free Games 7776 - 32768 Ways

DENOMINATIONS

1¢

BET CONFIGURATIONS

1, 2, 3, 4, 5

MAX BET

400 Credits

The number of free games also determines the number of extra free games awarded during retriggers. At the conclusion of the free games feature, the player is given a wheel spin and a chance to win a credit prize multiplier, one of two bonus prizes, or two levels of progressive jackpots!

HYPER Speed

Speed

VIDEO GAMING MACHINE™

People Matter • Performance Matters • Price Matters



Speed

CABINET FEATURE

- Dual 27" Ultra High Definition Monitor
- Premium Speed LCD Touch Screen panel with Bash Button
- USB Charging Port & Wireless Charger
- Dual Logic PC Capability
- Immersive Audio & Visual Experience
- 27" Topper Available
- Optimal service design for accessibility and maintenance



VIDEO GAMING MACHINE™

CABINET SPECIFICATION

DIMENSIONS	
Depth	18.1"
Width	26.77"
Height	74.82"
Height (Tower Light Included)	78.92"



Welcome to the exciting world of Poker Slot Blitz Stud Multipliers 3R5LI Experience the thrill of hitting a Royal Flush like never before! With our exciting feature, hitting a Royal Flush with a 9x multiplier at max bet triggers the Blitz Progressive, giving you a chance to big win. So go ahead and play your hand - the next Royal Flush could be the one that triggers the Blitz Progressive and changes your fortunes forever!

SUPER STUD POKER FEATURE



With the Super Stud Poker Feature enabled at max wager, the excitement goes to the next level. With 7 cards active and a multiplier of 1x-9x, every spin could be your lucky one. At the end of each spin, if seven cards are visible, you'll receive a payout for your poker stud hand.

SUPER STUD POKER PAYS (CREDITS)					
COMBO	Bet 1+4	Bet 2+4	Bet 3+4	Bet 4+4	Bet 5+4
ROYAL FLUSH	1,000	1,250	1,500	1,750	2,000
STRAIGHT FLUSH	400	400	400	400	400
FOUR OF A KIND	200	200	200	200	200
FULL HOUSE	48	48	48	48	48
FLUSH	32	32	32	32	32
STRAIGHT	24	24	24	24	24
THREE OF A KIND	16	16	16	16	16
TWO PAIR	8	8	8	8	8
ANY PAIR	4	4	4	4	4
NOTHING	0	0	0	0	0

Speed



TYPE OF FEATURES

Stud Poker Feature

REEL CONFIGURATION

3-Reel Video Slot

PAYLINES

5 Lines

DENOMINATIONS

10¢, 25¢, 50¢, \$1, \$2, \$5, \$10, \$20, \$50, \$100, \$250

BET CONFIGURATIONS

1, 2, 3, 4, 5, 6, 7, 8, 9

MAX BET

9 Credits

Orb of Wealth™





Powerful repeating wins when fate and luck combine. Special scatter symbols trigger the free games feature in which the sum of credit prizes displayed on these triggering symbols is paid for each scatter that appears during the free games. When one or more wild symbols appear in a bought game, there is a chance to trigger the jackpot feature containing four progressive levels.

JACKPOT FEATURE



There is a chance that the JACKPOT FEATURE may be triggered when 1 or more **WILD** appear in bought games only.

In the JACKPOT FEATURE, there are 4 types of jackpot symbols hidden behind 12 icons.

Select an icon until 3 matching jackpot symbols corresponding to a JACKPOT are revealed.

FREE GAMES FEATURE



Any 6 or more **ORB** in a bought game trigger 6 free games.

Each **ORB** that appears during the free games pays the ORB PRIZE.

Before the free games start, the ORB PRIZE credit amount is determined as the sum of numbers that are displayed on all **ORB** appearing in the bought game that triggered the free games.

Royal symbols do not appear in free games.



TYPE OF FEATURES

Free Game + LP

REEL CONFIGURATION

5-Reel 3-Row Video Slot

PAYLINES

243 Ways

DENOMINATIONS

1¢

BET CONFIGURATIONS

1, 2, 3, 4, 5, 6, 7, 8, 9, 10

MAX BET

88 Bet to 880 Bet

(Depends on the above Bet Configurations)



Powerful repeating wins when fate and luck combine. Special scatter symbols trigger the free games feature in which the sum of credit prizes displayed on these triggering symbols is paid for each scatter that appears during the free games. When one or more wild symbols appear in a bought game, there is a chance to trigger the jackpot feature containing four progressive levels.

JACKPOT FEATURE



There is a chance that the JACKPOT FEATURE may be triggered when 1 or more **WILD** appear in bought games only.

In the JACKPOT FEATURE, there are 4 types of jackpot symbols hidden behind 12 icons. Select an icon until 3 matching jackpot symbols corresponding to a JACKPOT are revealed.

FREE GAMES FEATURE



Any 6 or more **ORB** in a bought game trigger 6 free games.

Each **ORB** that appears during the free games pays the ORB PRIZE.

Each **WILD** that appears during the free games awards 1 additional free game.

Before the free games start, the ORB PRIZE credit amount is determined as the sum of numbers that are displayed on all **ORB** appearing in the bought game that triggered the free games.

TYPE OF FEATURES

Free Game + LP

REEL CONFIGURATION

5-Reel 3-Row Video Slot

PAYLINES

243 Ways

DENOMINATIONS

1¢

BET CONFIGURATIONS

1, 2, 3, 4, 5, 6, 7, 8, 9, 10

MAX BET

88 Bet to 880 Bet

(Depends on the above Bet Configurations)

BOUND FOR RICHES™





Chool Chool Hop on board the golden express destined for cash and prizes. All prizes displayed on special scatter symbols that are held during the collect feature are won, including bonus and jackpot prizes. When the special scatters fill the reels in any game, additional prizes including bonuses and jackpots are won in a pick game. Additionally, jackpots may be won randomly during bought games. Free games feature reels with extra wild.

FREE GAMES FEATURE



COLLECT FEATURE



PRIZE PICK FEATURE



JACKPOT SURPRISE



TYPE OF FEATURES

Free Game + LP

REEL CONFIGURATION

5-Reel 3-Row Video Slot

PAYLINES

50 Lines (Denomination 1 & 2)

25 Lines (Denomination 3 & 4)

5 Lines (Denomination 5 & 6)

DENOMINATIONS

1	2	3	4	5	6
1c	2c	5c	10c	\$1	\$2
2c	5c	10c	20c	\$2	\$5
5c	10c	25c	50c	\$5	\$10
10c	20c	50c	\$1	\$10	\$20
20c	50c	\$1	\$2	\$20	\$50
50c	\$1	\$2.50	\$5	\$50	\$100
\$1	\$2	\$5	\$10	\$100	\$200
1c	2c	5c	10c		
2c	5c	10c	20c		
5c	10c	25c	50c		
10c	20c	50c	\$1		
20c	50c	\$1	\$2		
50c	\$1	\$2.50	\$5		
\$1	\$2	\$5	\$10		
\$5	\$10	\$25	\$50		
\$10	\$20	\$50	\$100		

BET CONFIGURATIONS

1, 2, 3, 4, 5

1, 2, 3, 5, 10

MAX BET

250, 500 (Denomination 1 & 2)

125, 250 (Denomination 3 & 4)

25, 50 (Denomination 5 & 6)



Chool Chool Hop on board the golden express destined for cash and prizes. All prizes displayed on special scatter symbols that are held during the collect feature are won, including bonus and jackpot prizes. When the special scatters fill the reels in any game, additional prizes including bonuses and jackpots are won in a pick game. Additionally, jackpots may be won randomly during bought games. Free games feature mystery symbols that all become the same symbol.

FREE GAMES FEATURE



COLLECT FEATURE



PRIZE PICK FEATURE



JACKPOT SURPRISE



TYPE OF FEATURES

Free Game + LP

REEL CONFIGURATION

5-Reel 3-Row Video Slot

PAYLINES

50 Lines (Denomination 1 & 2)

25 Lines (Denomination 3 & 4)

5 Lines (Denomination 5 & 6)

DENOMINATIONS

1	2	3	4	5	6
1c	2c	5c	10c	\$1	\$2
2c	5c	10c	20c	\$2	\$5
5c	10c	25c	50c	\$5	\$10
10c	20c	50c	\$1	\$10	\$20
20c	50c	\$1	\$2	\$20	\$50
50c	\$1	\$2.50	\$5	\$50	\$100
\$1	\$2	\$5	\$10	\$100	\$200
1c	2c	5c	10c		
2c	5c	10c	20c		
5c	10c	25c	50c		
10c	20c	50c	\$1		
20c	50c	\$1	\$2		
50c	\$1	\$2.50	\$5		
\$1	\$2	\$5	\$10		
\$5	\$10	\$25	\$50		
\$10	\$20	\$50	\$100		

BET CONFIGURATIONS

1, 2, 3, 4, 5

1, 2, 3, 5, 10

MAX BET

250, 500 (Denomination 1 & 2)

125, 250 (Denomination 3 & 4)

25, 50 (Denomination 5 & 6)



TYPE OF FEATURES

Free Game + LP

REEL CONFIGURATION

5-Reel 3-Row Video Slot

PAYLINES

50 Lines (Denomination 1 & 2)

25 Lines (Denomination 3 & 4)

5 Lines (Denomination 5 & 6)

DENOMINATIONS

1	2	3	4	5	6
1c	2c	5c	10c	\$1	\$2
2c	5c	10c	20c	\$2	\$5
5c	10c	25c	50c	\$5	\$10
10c	20c	50c	\$1	\$10	\$20
20c	50c	\$1	\$2	\$20	\$50
50c	\$1	\$2.50	\$5	\$50	\$100
\$1	\$2	\$5	\$10	\$100	\$200
1c	2c	5c	10c		
2c	5c	10c	20c		
5c	10c	25c	50c		
10c	20c	50c	\$1		
20c	50c	\$1	\$2		
50c	\$1	\$2.50	\$5		
\$1	\$2	\$5	\$10		
\$5	\$10	\$25	\$50		
\$10	\$20	\$50	\$100		

BET CONFIGURATIONS

1, 2, 3, 4, 5

1, 2, 3, 5, 10

MAX BET

250, 500 (Denomination 1 & 2)

125, 250 (Denomination 3 & 4)

25, 50 (Denomination 5 & 6)

Chool Chool Hop on board the golden express destined for cash and prizes. All prizes displayed on special scatter symbols that are held during the collect feature are won, including bonus and jackpot prizes. When the special scatters fill the reels in any game, additional prizes including bonuses and jackpots are won in a pick game. Additionally, jackpots may be won randomly during bought games. Free games feature wild that nudge the reel making it all wild.

FREE GAMES FEATURE



COLLECT FEATURE



PRIZE PICK FEATURE



JACKPOT SURPRISE



TYPE OF FEATURES

Free Game + LP

REEL CONFIGURATION

5-Reel 3-Row Video Slot

PAYLINES

50 Lines (Denomination 1 & 2)

25 Lines (Denomination 3 & 4)

5 Lines (Denomination 5 & 6)

DENOMINATIONS

1	2	3	4	5	6
1c	2c	5c	10c	\$1	\$2
2c	5c	10c	20c	\$2	\$5
5c	10c	25c	50c	\$5	\$10
10c	20c	50c	\$1	\$10	\$20
20c	50c	\$1	\$2	\$20	\$50
50c	\$1	\$2.50	\$5	\$50	\$100
\$1	\$2	\$5	\$10	\$100	\$200
1c	2c	5c	10c		
2c	5c	10c	20c		
5c	10c	25c	50c		
10c	20c	50c	\$1		
20c	50c	\$1	\$2		
50c	\$1	\$2.50	\$5		
\$1	\$2	\$5	\$10		
\$5	\$10	\$25	\$50		
\$10	\$20	\$50	\$100		

BET CONFIGURATIONS

1, 2, 3, 4, 5

1, 2, 3, 5, 10

MAX BET

250, 500 (Denomination 1 & 2)

125, 250 (Denomination 3 & 4)

25, 50 (Denomination 5 & 6)

Chool Chool Hop on board the golden express destined for cash and prizes. All prizes displayed on special scatter symbols that are held during the collect feature are won, including bonus and jackpot prizes. When the special scatters fill the reels in any game, additional prizes including bonuses and jackpots are won in a pick game. Additionally, jackpots may be won randomly during bought games.

FREE GAMES FEATURE



COLLECT FEATURE



PRIZE PICK FEATURE



JACKPOT SURPRISE



Speed



TYPE OF FEATURES

Free Game

REEL CONFIGURATION

1-5 Reels Video Slot

PAYLINES

1 Line

DENOMINATIONS

25c, \$1, \$2, \$5, \$10

BET CONFIGURATIONS

1, 5, 10, 20

MAX BET

20 Credits



Relive the golden age of the 1920's in this new game. Players win the amount shown on the reels in this 3-reel, 1-line game. Two silver reels on either side may UNLOCK on any spin, granting one or two additional digits or more free spins. Players will flock to yours floors for a chance at huge payouts on this high denom game.

BASE GAME FEATURE

One pay line. The symbols are digits and a FREE SPINS scatter symbol.

The game pays the amount formed on the pay line by concatenating the digits, with the other symbols excluded.

RANDOM EXTRA REELS

On each paid game, the reels left and right of the main reels may become active.

FREE GAMES



Free games are triggered by 3, 4 or 5 scattered free game symbols.

During the free games the two reels to the left and right of the main reels are activated.

The number of free games awarded are 5, 10 or 15 free spins respectively.

The free spins may be retriggered.



Lucky the Pig eats all the fruit that have landed on the reels. As he eats, he grows larger, and the Free Spins multiplier may increase. The Free Spins multiplier ranges from 2x to 5x. On any spin, 7 Free Spins may be awarded. During the Free Spins all pays are multiplied, including Jackpots. Accrued wins during Free Spins will be awarded after the 7th spin, and the game will return to base game play.

FREE SPINS



After all wins are evaluated, determine if Lucky the Pig will award FREE SPINS.
7 FREE SPINS may awarded on any spin.



TYPE OF FEATURES
Free Game

REEL CONFIGURATION
3-Reel Video Slot

PAYLINES
1-9 Lines

DENOMINATIONS
25c, 50c, \$1, \$2, \$5

BET CONFIGURATIONS
1, 3, 5, 7, 9

MAX BET
9 Credits

CO CO CO COIN

EGYPTIAN TREASURE

CO CO CO COIN

PIRATES TREASURE





Wild keys of fortune possess the power to unlock golden riches. Jackpot, bonus and credit prizes on gold coins are won when appearing in any position on 3 or more consecutive reels beginning with the leftmost reel. More coins appear on the first three reels during free games and even more coins appear on all reels in a respin that is triggered randomly when wild appears during bought games.

TREASURE RESPIN



There is a chance that a TREASURE RESPIN is randomly triggered when 1 or more appear in bought spins only. After all wins are determined in the bought spin that triggers the TREASURE RESPIN, all reels respin automatically in one free spin and any new wins are added.

Different reels with extra on reels 1, 2, 3, 4 and 5 are used in the TREASURE RESPIN. TREASURE RESPIN cannot be triggered again in the TREASURE RESPIN.

FREE GAMES FEATURE



Any 3 or more trigger the free games feature awarding 10 free games. Different reels are used during the free games features. Reels 1, 2 and 3 contain extra during the free games feature compared to bought games.

Free games feature can be triggered again during the free games feature.

If the free games feature and TREASURE RESPIN are triggered in the same bought spin, the free games feature starts after the TREASURE RESPIN.

If the free games feature is then triggered again in the TREASURE RESPIN, the sum of free games awarded for the two triggered free games features are played in a single free games feature that starts after the TREASURE RESPIN ends.

JACKPOT AND BONUS PRIZES



are special bonus symbols that are excluded from wins. Prizes displayed on are paid one time only for all appearing in any position on 3 or more consecutive reels beginning with the leftmost reel.

Each displays 1 of the available prizes below:

- PRIZE AMOUNT: equal to the total credits bet multiplied by a randomly determined multiplier as displayed. Available multipliers correspond to the reel that appears on:
 - Reels 1 to 3: multipliers 1, 2, 3, 4, 5, 6, 8 and 10.
 - Reel 4: multipliers 1, 2, 3, 4, 5, 6, 8, 10, 15, 20, 30 and 40.
 - Reel 5: multipliers 1, 2, 3, 4, 5, 6, 8, 10, 15, 20, 30, 40, 50, 60, 100 and 200.
- MAJOR BONUS, MINOR BONUS or MINI BONUS
- GRAND JACKPOT or MEGA JACKPOT



TYPE OF FEATURES

Free Game

REEL CONFIGURATION

5-Reel 3-Row Video Slot

PAYLINES

243 Ways

DENOMINATIONS

1	2	3	4	5	6
1c	2c	5c	10c	\$1	\$2
5c	10c	25c	50c	\$5	\$10
10c	20c	50c	\$1	\$10	\$20
50c	\$1	\$2.50	\$5	\$50	\$100
\$1	\$2	\$5	\$10	\$100	\$200
1c	2c	5c	10c		
2c	5c	10c	20c		
5c	10c	25c	50c		
10c	20c	50c	\$1		
20c	50c	\$1	\$2		
50c	\$1	\$2.50	\$5		
\$1	\$2	\$5	\$10		
\$5	\$10	\$25	\$50		
\$10	\$20	\$50	\$100		

BET CONFIGURATIONS

- 1, 2, 3, 4, 5
- 1, 2, 3, 5, 8
- 1, 2, 3, 5, 10
- 1, 2, 5, 10, 20

MAX BET

- 250, 400, 500, 1000 (Denomination 1, 2)
- 125, 200, 250, 500 (Denomination 3, 4)
- 25, 40, 50, 100 (Denomination 5, 6)



Wild keys of fortune possess the power to unlock golden riches. Jackpot, bonus and credit prizes on gold coins are won when appearing in any position on 3 or more consecutive reels beginning with the leftmost reel. More coins appear on the first three reels during free games and even more coins appear on all reels in a respin that is triggered randomly when wild appears during bought games.

TREASURE RESPIN



There is a chance that a TREASURE RESPIN is randomly triggered when 1 or more  appear in bought spins only. After all wins are determined in the bought spin that triggers the TREASURE RESPIN, all reels respin automatically in one free spin and any new wins are added.

Different reels with extra  on reels 1, 2, 3, 4 and 5 are used in the TREASURE RESPIN. TREASURE RESPIN cannot be triggered again in the TREASURE RESPIN.

FREE GAMES FEATURE



Any 3 or more  trigger the free games feature awarding 10 free games. Different reels are used during the free games features. Reels 1, 2 and 3 contain extra  during the free games feature compared to bought games.



Free games feature can be triggered again during the free games feature.

If the free games feature and TREASURE RESPIN are triggered in the same bought spin, the free games feature starts after the TREASURE RESPIN.

If the free games feature is then triggered again in the TREASURE RESPIN, the sum of free games awarded for the two triggered free games features are played in a single free games feature that starts after the TREASURE RESPIN ends.

JACKPOT AND BONUS PRIZES



 are special bonus symbols that are excluded from wins. Prizes displayed on  are paid one time only for all  appearing in any position on 3 or more consecutive reels beginning with the leftmost reel.

Each  displays 1 of the available prizes below:

- PRIZE AMOUNT: equal to the total credits bet multiplied by a randomly determined multiplier as displayed. Available multipliers correspond to the reel that  appears on:
 - Reels 1 to 3: multipliers 1, 2, 3, 4, 5, 6, 8 and 10.
 - Reel 4: multipliers 1, 2, 3, 4, 5, 6, 8, 10, 15, 20, 30 and 40.
 - Reel 5: multipliers 1, 2, 3, 4, 5, 6, 8, 10, 15, 20, 30, 40, 50, 60, 100 and 200.
- MAJOR BONUS, MINOR BONUS or MINI BONUS
- GRAND JACKPOT or MEGA JACKPOT

TYPE OF FEATURES

Free Game

REEL CONFIGURATION

5-Reel 3-Row Video Slot

PAYLINES

243 Ways

DENOMINATIONS

1	2	3	4	5	6
1c	2c	5c	10c	\$1	\$2
5c	10c	25c	50c	\$5	\$10
10c	20c	50c	\$1	\$10	\$20
50c	\$1	\$2.50	\$5	\$50	\$100
\$1	\$2	\$5	\$10	\$100	\$200
1c	2c	5c	10c		
2c	5c	10c	20c		
5c	10c	25c	50c		
10c	20c	50c	\$1		
20c	50c	\$1	\$2		
50c	\$1	\$2.50	\$5		
\$1	\$2	\$5	\$10		
\$5	\$10	\$25	\$50		
\$10	\$20	\$50	\$100		

BET CONFIGURATIONS

1, 2, 3, 4, 5
 1, 2, 3, 5, 8
 1, 2, 3, 5, 10
 1, 2, 5, 10, 20

MAX BET

250, 400, 500, 1000 (Denomination 1, 2)
 125, 200, 250, 500 (Denomination 3, 4)
 25, 40, 50, 100 (Denomination 5, 6)

DANCING PANDA™ FORTUNE

DANCING PANDA™ FESTIVAL





Happy blessings come from wild surprises. During bought games and free games, multiple lower-paying symbol kinds on all reels may randomly become a single higher-paying symbol kind. Alternatively, line wins may be multiplied by randomly appearing multiplier wild symbols. When wild symbols appear, there is a chance to trigger a special prize reel that awards jackpots, free games or both. Multiple jackpots may be won on the special prize reel.

RANDOM FEATURES

RANDOM WILD

RANDOM WILD randomly occurs during bought games and free games. All / substituting in a line win multiply the pay for that line only.

CHANGE UP

CHANGE UP randomly occurs during bought games and free games.

In the spin that CHANGE UP occurs, all **A, K, Q, J, 10** and **9** on the reels change to 1 of the following symbols: , , , , or .



TYPE OF FEATURES

Free Game + LP

REEL CONFIGURATION

5-Reel 3-4-4-4-3-Row Video Slot

PAYLINES

32 Lines

DENOMINATIONS

1¢

BET CONFIGURATIONS

1, 2, 3, 4, 5, 6, 7, 8, 9, 10

MAX BET

Up to 680

(Depends on the above Bet Configurations)

FREE GAMES

3 or more scattered trigger the free games. During the free games, each awards 1, 2 or 3 additional free games.



PRIZE REEL

There is a chance PRIZE REEL may be triggered when / / appear during any bought game or free game.

When the PRIZE REEL is triggered, a large PRIZE REEL is displayed on the game screen and spun once only. If the PRIZE REEL indicates only a jackpot win, the jackpot is won and there is a chance that the PRIZE REEL may spin again.





Happy blessings come from wild surprises. During bought games, multiple symbol kinds on all reels may randomly become wild symbols. During bought games and free games, line wins may be multiplied by randomly appearing multiplier wild symbols. When wild symbols appear, there is a chance to trigger a special prize reel that awards jackpots, free games or both. Multiple jackpots may be won on the special prize reel.

RANDOM FEATURES

RANDOM WILD

RANDOM WILD randomly occurs during bought games and free games. All / substituting in a line win multiply the pay for that line only.

WILD CHANGE

WILD CHANGE randomly occurs during bought games only.

In the game that WILD CHANGE occurs, 3 or more of the symbol kinds / / / / on all reels randomly change to .



FREE GAMES

Free games consist of 8 free games. During free games, 3 or more scattered award 5 additional free games. Different reels are used during the free games.



PRIZE REEL

There is a chance PRIZE REEL may be triggered when / / appear during any bought game or free game.

When the PRIZE REEL is triggered, a large PRIZE REEL is displayed on the game screen and spun once only. If the PRIZE REEL indicates only a jackpot win, the jackpot is won and there is a chance that the PRIZE REEL may spin again.



TYPE OF FEATURES

Free Game + LP

REEL CONFIGURATION

5-Reel 3-4-4-4-3-Row Video Slot

PAYLINES

32 Lines

DENOMINATIONS

1¢

BET CONFIGURATIONS

1, 2, 3, 4, 5, 6, 7, 8, 9, 10

MAX BET

Up to 680
(Depends on the above Bet Configurations)

FU LAI CAI LAI 福来财来

5 SEA
LEGENDS™

TRIPLE
FESTIVAL™

STACK WILD
LUXURY™

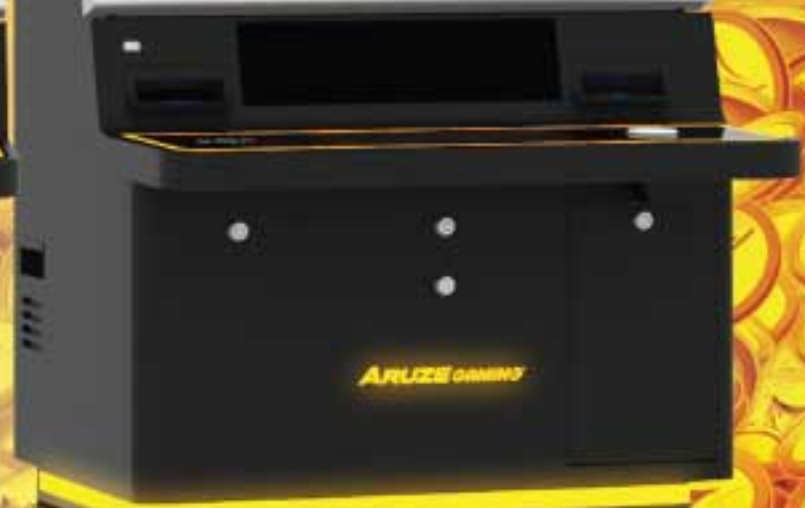



Experience an enriching variety of gameplay and surprising riches. Increasing the bet level and credit per play improve several elements of gameplay.

TYPE OF FEATURES

Free Game + LP

REEL CONFIGURATION

5-Reel 3-Row Video Slot

PAYLINES

243 Ways

DENOMINATIONS

1¢

BET CONFIGURATIONS

1, 2, 3, 6, 10

MAX BET

880

FU LAI CAI LAI TRIPLE FESTIVAL

appearing on 3 or more consecutive reels beginning with the leftmost reel trigger the free games feature with 8 free games. During free games feature, reels contains Picture symbols only.

Free games feature can be triggered again during the free games feature.

If the free games feature is triggered in the same game as the JACKPOT FEATURE, the free games feature starts after the JACKPOT FEATURE ends.

FU LAI CAI LAI 5 SEA LEGENDS

appearing on 3 or more consecutive reels beginning with the leftmost reel trigger the free games feature with 6 free games.

Before free games start, select 1 of the symbols from the available options.

If the free games feature was triggered when playing bet level 2 or higher, the reels used during the free games are composed with the following symbols only: the symbol selected from the available options, , , .

, , , , and .

If the free games feature was triggered when playing bet level 1, the reels used during the free games are composed with the following symbols only: the symbol selected from the available options, , .

, , , , and .

During the free games, appearing on 3 or more consecutive reels beginning with the leftmost reel award an additional 6 free games, however the selection of the symbol option is not made again.

If the free games feature is triggered in the same game as the JACKPOT FEATURE, the free games feature starts after the JACKPOT FEATURE ends.

FU LAI CAI LAI STACK WILD LUXURY

appearing on 3 or more consecutive reels beginning with the leftmost reel trigger the free games feature with 8 free games.

During the free games, all symbols on 1 or more reels (reels 2, 3, 4 and 5 according to bet level played) may randomly become .

Free games feature cannot be triggered again during the free games feature.

If the free games feature is triggered in the same game as the JACKPOT FEATURE, the free games feature starts after the JACKPOT FEATURE ends.



JACKPOT FEATURE

The JACKPOT FEATURE can be triggered when playing bet level 2, 3, 4 or 5 only. There is a chance the JACKPOT FEATURE may be triggered when appears.

Alternatively, the JACKPOT FEATURE is triggered when the large drops down to be displayed on the game screen randomly in bought games and free games.

According to the bet level played, up to 4 jackpot levels may be available. In the JACKPOT FEATURE, select from 15 ingots until 3 matching symbols corresponding to a jackpot level are revealed.

If 3 are revealed, an additional JACKPOT FEATURE is awarded and the feature continues until a jackpot level is won.

When 3 matching jackpot level symbols have been revealed, the corresponding jackpot level is won and the JACKPOT FEATURE ends. Any additional JACKPOT FEATURE awarded, starts after the preceding JACKPOT FEATURE ends.

WILD COIN BONUS

There is a chance the WILD COIN BONUS may occur when 1 or more appear on the reels in a bought game or free game. When the WILD COIN BONUS occurs, a special credit prize displayed on the game screen is awarded. Special Credit Prize: total credits bet multiplied by either 10, 20, 30, 50 or 100 randomly as displayed.



Watch for rolling WILD snowballs to multiply your wins. Players will love watching the snowball WILDS roll up the screen and increase the multipliers, and then fly up and make the snowman grow. When the snowman gets too big, he will award the FREE SPINS bonus, with more chances of bigger multiplier WILDS!



TYPE OF FEATURES

Free Game

REEL CONFIGURATION

5-Reel 3-Row Video Slot

PAYLINES

243 Ways

DENOMINATIONS

1¢, 2¢, 5¢, 10¢

BET CONFIGURATIONS

60, 120, 180, 360, 540

MAX BET

540 Credits

SNOWMAN FEATURE

Perceived persistence Free Spins trigger and multiplicative snowball WILDS.

Snowman may award 15 Free Games on any spin.

Snowball WILD symbols fly to snowman when they roll off top reel.

Snowman may grow fatter, or coin pile may grow larger.

WILD SNOWBALL FEATURE



WILD snowball symbols persist for 3 spins.

WILD snowballs may land on bottom of reels 2 through 4.

WILDS persistent until they 'roll' upward off screen; then fly up to top screen to grow the snowman character.

Snowballs start as a 1x WILD, each 'roll' up the screen increases the multiplier by 1x to a maximum of 3x.



FORTUNE DRUMS™





Spinning riches stir up excitement. Picture symbols are increased on reels according to the credits bet played. Special reels comprised exclusively of Picture, "Feature" and "Wild" symbols are used during the 10 free games. In DON DON DON, a big win awaits as either a bonus credit prize or 1 of 4 progressive levels is won.

FREE GAMES



DON DON DON



TYPE OF FEATURES

Video Wheel / Free Game + LP

REEL CONFIGURATION

5-Reel 3-Row Video Slot

PAYLINES

243 Ways

DENOMINATIONS

1c

BET CONFIGURATIONS

1, 2, 3, 4, 5
1, 2, 3, 5, 10
1, 2, 5, 10, 15
1, 2, 5, 10, 20

MAX BET

440, 880, 1320, 1760



Spinning riches stir up excitement. Picture symbols are increased on reels according to the credits bet played. When the feature is triggered a mini game occurs, improving the reels used during 6 free games. In DON DON DON, a big win awaits as either a bonus credit prize or 1 of 4 progressive levels is won.

ZODIAC FEATURE



DON DON DON



TYPE OF FEATURES

Video Wheel / Free Game + LP

REEL CONFIGURATION

5-Reel 3-Row Video Slot

PAYLINES

243 Ways

DENOMINATIONS

1c

BET CONFIGURATIONS

1, 2, 3, 4, 5
1, 2, 3, 5, 10
1, 2, 5, 10, 15
1, 2, 5, 10, 20

MAX BET

440, 880, 1320, 1760



Spinning riches stir up excitement. Picture symbols are increased on reels according to the credits bet played. 3 symbols held on reel 3 are used during 10 free games. In DON DON DON, a big win awaits as either a bonus credit prize or 1 of 4 progressive levels is won.

TYPE OF FEATURES

Video Wheel / Free Game + LP

REEL CONFIGURATION

5-Reel 3-Row Video Slot

PAYLINES

243 Ways

DENOMINATIONS

1¢

BET CONFIGURATIONS

- 1, 2, 3, 4, 5
- 1, 2, 3, 5, 10
- 1, 2, 5, 10, 15
- 1, 2, 5, 10, 20

MAX BET

440, 880, 1320, 1760

FREE GAMES



DON DON DON



Spinning riches stir up excitement. Picture symbols are increased on reels according to the credits bet played. Special reels with consecutive wild symbols and no Royal symbols are used during the 8 free games. In DON DON DON, a big win awaits as either a bonus credit prize or 1 of 4 progressive levels is won.

TYPE OF FEATURES

Video Wheel / Free Game + LP

REEL CONFIGURATION

5-Reel 3-Row Video Slot

PAYLINES

243 Ways

DENOMINATIONS

1¢

BET CONFIGURATIONS

- 1, 2, 3, 4, 5
- 1, 2, 3, 5, 10
- 1, 2, 5, 10, 15
- 1, 2, 5, 10, 20

MAX BET

440, 880, 1320, 1760

FREE GAMES



DON DON DON



COIN COLLECTOR™



COIN COLLECTOR™



Amass golden riches and rack up lots of free games. The number of free games awarded is determined by a number drawing conducted on each triggering feature symbol. Transforming symbols in bought games and free games all become the same symbol. Special scatters can trigger a collect feature in which all prizes displayed on the collected scatters are won, including bonuses and jackpots. Additionally, jackpots can be won randomly during bought games.

TYPE OF FEATURES

Free Game + LP

REEL CONFIGURATION

5-Reel 4-Row Video Slot

PAYLINES

50 Lines

25 Lines

4 Lines (Denomination 4, 5, 6 only)

DENOMINATIONS

1	2	3	4	5	6
1c	2c	5c	10c	\$1	\$2
5c	10c	25c	50c	\$5	\$10
10c	20c	50c	\$1	\$10	\$20
50c	\$1	\$2.50	\$5	\$50	\$100
2c	5c	10c	20c	\$2	\$5
20c	50c	\$1	\$2	\$20	\$50
1c	2c	5c	10c		
10c	20c	50c	\$1		
50c	\$1	\$2.50	\$5		
\$1	\$2	\$5	\$10		
\$5	\$10	\$25	\$50		
\$10	\$20	\$50	\$100		
2c	5c	10c	20c		
20c	50c	\$1	\$2		

BET CONFIGURATIONS

1, 2, 3, 4, 5

1, 2, 3, 5, 10

MIN/MAX BET

250, 500

125, 250

20, 40 (Denomination 4, 5, 6 only)

5 GUARDIANS / AUSSIE 5 FEATURE

appearing on 3 or more consecutive reels beginning with the leftmost reel trigger 5 GUARDIANS / AUSSIE 5 FEATURE.

When the GUARDIANS / AUSSIE 5 FEATURE is triggered, a number appears on each that was involved in triggering the feature.

The sum of the numbers that appeared is awarded as free games in the GUARDIANS / AUSSIE 5 FEATURE.



MYSTERY SYMBOL

COIN COLLECTOR 5 GUARDIANS

appearing on the reels changes to after all reels finish spinning. All appearing in the same game randomly change to the same symbol.

COIN COLLECTOR AUSSIE 5

appearing on the reels changes to after all reels finish spinning. All appearing in the same game randomly change to the same symbol.



DREAM COLLECTOR

Any 6 or more scattered in a bought game or free game trigger DREAM COLLECTOR and are held for the duration of DREAM COLLECTOR. When DREAM COLLECTOR is triggered, 3 free spins are awarded.

Each newly appearing in DREAM COLLECTOR resets the number of remaining free spins to 3.

DREAM COLLECTOR ends after all awarded free spins have been played or if appears in all 20 symbol positions. GRAND JACKPOT is won if appears in all 20 symbol positions. prizes are added to the GRAND JACKPOT win.



JACKPOT SURPRISE

JACKPOT SURPRISE randomly occurs in bought games only.

When the JACKPOT SURPRISE occurs, 1 of the following prizes is randomly awarded:

- MAJOR JACKPOT
- GRAND JACKPOT
- BONUS



SUNLIGHT™ SAVANNA 5

SUNLIGHT™ JOYFUL LION



SUNLIGHT™

HYPER SYMBOL wins multiplied by total number of all matching symbols on the same reels. Rather than lines or ways, standard wins are based on the number of left-to-right reels with matching HYPER SYMBOL that are then multiplied by the total number of all matching HYPER SYMBOL on those winning reels.

TYPE OF FEATURES

Free Game + LP

REEL CONFIGURATION

5-Reel 3-Row Video Slot

PAYLINES

Hyper Symbols

DENOMINATIONS

1¢

BET CONFIGURATIONS

1, 2, 3, 4, 5

1, 2, 3, 5, 10

1, 2, 5, 10, 20

MAX BET

250, 500, 1000

FREE GAMES FEATURE

SUNLIGHT SAVANNA 5



Any 6 or more trigger the FREE GAMES FEATURE with an initial 5 free games and an initial x4 special multiplier that multiplies the HYPER SYMBOL MULTIPLIER.

Different reels are used during the FREE GAMES FEATURE.

Before the FREE GAMES FEATURE starts, each triggering reveals 1 of the following:

+1 : Each +1 revealed awards 1 additional free game.

x1 : Each x1 revealed increases the special multiplier applied during all free games by 1.

During the FREE GAMES FEATURE, any 6 or more each reveal +1 awarding a total number of additional free games equal to the number of appearing only.

FREE GAMES FEATURE starts after the JACKPOT FEATURE ends if triggered in the same game.

If the JACKPOT FEATURE is triggered during the FREE GAMES FEATURE, any remaining free games resume after the JACKPOT FEATURE ends.

SUNLIGHT JOYFUL LION



Any 6 or more trigger the FREE GAMES FEATURE with 10 free games.

Different reels are used during the FREE GAMES FEATURE.

Reels used during the FREE GAMES FEATURE contain an additional 30 , 60 or 120 randomly.

During the FREE GAMES FEATURE, any 6 or more award 10 additional free games. FREE GAMES FEATURE starts after the JACKPOT FEATURE ends if triggered in the same game.

If the JACKPOT FEATURE is triggered during the FREE GAMES FEATURE, any remaining free games resume after the JACKPOT FEATURE ends. Credits bet during the FREE GAMES FEATURE are the same as the game that triggered the FREE GAMES FEATURE.

JACKPOT FEATURE



Any combination of SUN SYMBOLS appearing on 3 or more consecutive reels beginning with the leftmost reel trigger the JACKPOT FEATURE.

In the JACKPOT FEATURE, the triggering SUN SYMBOLS are shuffled and then each is hidden behind a . SUN SYMBOL prizes are revealed after the is selected in the JACKPOT FEATURE.

Select 1 only to reveal the SUN SYMBOL and corresponding prize won for the JACKPOT FEATURE.

JACKPOT FEATURE win is added to any HYPER SYMBOL wins from the triggering game.

Jack's HAUNTED WINS

Jack's WINNING SPELL



In addition to free games, there is a chance to trigger a wide variety of unique features whenever wild symbols appear. Enjoy special prize reels, scattered wild, cascading wild, merging reels, a bonus collect feature and a special multiplier reel that increases all bonus wins and also awards jackpots.

TYPE OF FEATURES

Free Game + LP

REEL CONFIGURATION

5-Reel 3-4-4-4-3-Row Video Slot

PAYLINES

40 Lines

DENOMINATIONS

1¢

BET CONFIGURATIONS

1, 2, 3, 4, 5, 6, 7, 8, 9, 10

MAX BET

Up to 600

(Depends on the above Bet Configurations)

MEGA SYMBOL

After all wins are determined in the game that MEGA SYMBOL is awarded, reels 2, 3 and 4 merge to form one large center reel for 1 free spin only.

In the free spin, reels 1 and 5 are held and only the large center reel is spun.

PRIZE REEL

In PRIZE REEL, select 1 of 3 TOMBSTONE to reveal the number of prize reel spins awarded: 1 SPIN, 2 SPINS or 3 SPINS.

After the number of awarded prize reel spins has been revealed, a large pumpkin containing the prize reel appears on the game screen.

WILD REEL SPIN

After all wins are determined in the game that WILD REEL SPIN is awarded, overlaying WILD symbol cascade down all reels and may appear in any symbol position.

After the overlaying WILD symbol have cascaded down the reels, all wins are determined one more time.

RANDOM WILD

After all wins are determined in the game that RANDOM WILD is awarded, extra WILD symbol appears in 4 to 10 random symbol positions.

After the extra WILD symbol have appeared in random symbol positions, all wins are determined one more time.

HOLD SPIN BONUS

HOLD SPIN BONUS consists of 3 free spins.

Each new BONUS symbol that appears during HOLD SPIN BONUS resets the number of remaining free spins to 3 and is held in position until HOLD SPIN BONUS ends.

After the credit prize or special credit prize is awarded, a MULTIPLIER REEL on the top screen is spun once only.

JACK'S HAUNTED WINS

FREE GAMES



Free games consists of a mini game and 8 free games.

In the mini game, select 1 of 5 to reveal the number of extra added to the free games reels.

JACK'S WINNING SPELL

FREE GAMES



Free games consists of 7 free games.

In each free game during the free games, from 1 to 2 randomly selected reels change to .

DRAGONGONG™



Machine 1	Machine 2	Machine 3	Machine 4	Machine 5	Machine 6
\$100,000.01	\$100,000.01	\$100,000.01	\$100,000.01	\$100,000.01	\$100,000.01
\$1,000.01	\$1,000.01	\$1,000.01	\$1,000.01	\$1,000.01	\$1,000.01
\$22.52 \$13.57	\$22.53 \$13.59	\$22.52 \$13.57	\$22.53 \$13.59	\$22.52 \$13.57	\$22.53 \$13.59
1 0000	3 0000	1 0000	3 0000	4 0000	2 0000
GRAND	MINI	MAJOR	MINI	MINOR	MINI
2 0000	5 0000	2 0000	5 0000	1 0000	3 0000
MINI	4 0000	2 0000	MINI	GRAND	5 0000

DRAGONG LION

DRAGONG PHOENIX

Spinning riches stir up excitement. Picture symbols are increased on reels according to the credits bet played. In DRAGONG, a big win awaits as either a bonus credit prize or 1 of 4 progressive levels is won.

TYPE OF FEATURES

Video Wheel / Free Game + LP

REEL CONFIGURATION

5-Reel 3-Row Video Slot

PAYLINES

243 Ways

DENOMINATIONS

1¢

BET CONFIGURATIONS

1, 2, 3, 4, 5

1, 2, 3, 5, 10

1, 2, 5, 10, 15

1, 2, 5, 10, 20

MAX BET

440, 880, 1320, 1760

3 POD



4 POD



4 UNITS





6 UNITS













DRAGONG LION



LION FEATURE

 appearing on 3 or more consecutive reels beginning with the leftmost reel trigger the LION FEATURE. The LION FEATURE consists of a mini game and 6 free games. In the mini game, select 1 of 5  to reveal .

Different reels are used during the free games. Reels used during the free games are composed with the following symbols only: the revealed symbol from the mini game, , , , , , , ,  and . During the free games,  appearing on 3 or more consecutive reels beginning with the leftmost reel award an additional 6 free games, however the mini game is not played again.

If LION FEATURE and DRAGONG are triggered in the same game, LION FEATURE starts after DRAGONG ends. If DRAGONG is triggered during free games, any remaining free games resume after DRAGONG ends.

DRAGONG PHOENIX



FREE GAMES

 appearing on 3 or more consecutive reels beginning with the leftmost reel trigger 10 free games. Different reels are used during the free games. Free games can be triggered again during the free games. If free games and DRAGONG are triggered in the same game, free games start after DRAGONG ends. If DRAGONG is triggered during free games, any remaining free games resume after DRAGONG ends.



DRAGONG

There is a chance DRAGONG may be triggered when  appears.

Alternatively during bought games only, the top-paying symbol appearing on 3 or more consecutive reels beginning with the leftmost reel may trigger DRAGONG.

In DRAGONG, the large prize reel displayed on the screen is spun once only.

After the reel is spun, 1 prize is won as indicated by the pointer at the bottom of the reel.

Prizes displayed on the reel are from among the following available prizes.

Credit Prizes: 1000, 1200, 1500, 2000, 2500, 3000, 4000 and 5000.

Jackpots: GRAND, MAJOR, MINOR and MINI.

JIJIFU™



Machine 1	Machine 2	Machine 3	Machine 4	Machine 5	Machine 6
JIJIFU \$2,500.07 \$500.09 \$25.00 \$10.00	JIJIFU \$2,500.06 \$500.08 \$25.00 \$10.00	JIJIFU \$2,500.07 \$500.09 \$25.00 \$10.00	JIJIFU \$2,500.06 \$500.08 \$25.00 \$10.00	JIJIFU \$2,500.07 \$500.09 \$25.00 \$10.00	JIJIFU \$2,500.06 \$500.08 \$25.00 \$10.00
1054	1046	1054	1046	1054	1046

Collecting Mystery orb with amazing chance of prizes. Feature symbols trigger collect and super collect in which all transform into higher valued orb prize. Msytery Orbs triggered can win all prizes on features which gives bigger prizes. Additionally, jackpots may be won during bought games.

TYPE OF FEATURES

Free Game + LP

REEL CONFIGURATION

5-Reel 5-Row Video Slot

PAYLINES

7 Lines

DENOMINATIONS

1¢

BET CONFIGURATIONS

1, 2, 3, 4, 5, 6, 7, 8, 9, 10

MAX BET

880

(Depends on the above Bet Configurations)

COLLECT FEATURE



☘ appearing on 3 or more consecutive reels beginning with the leftmost reel trigger the COLLECT FEATURE. The triggering ☘ becomes ☑ and are held in position for the duration of the COLLECT FEATURE. When COLLECT FEATURE is triggered, 3 free spins are awarded. Each newly appearing ☑ in a free spin resets the number of remaining free spins to 3 and is held in position until the COLLECT FEATURE ends. COLLECT FEATURE starts after JACKPOT WHEEL ends if triggered in the same bought game. COLLECT FEATURE ends after all awarded free spins have been played or ☑ appears in all 25 symbol positions. Prizes displayed on ☑ are paid one time only for held ☑ on the reels at the end of COLLECT FEATURE only. GRAND JACKPOT is won if ☑ appears in all 25 symbol positions. ☑ prizes are added to the GRAND JACKPOT WIN. ☑ prizes won at the end of the COLLECT FEATURE are added to the prizes from the game that triggered the COLLECT FEATURE.

SUPER COLLECT FEATURE



Any combination of ☘ and ☙ appearing on 3 or more consecutive reels beginning with the leftmost reel trigger the SUPER COLLECT FEATURE.

Before the SUPER COLLECT FEATURE starts, each of the triggering ☘ becomes ☑ and each of the triggering ☙ becomes ☚, and all are held in position until the SUPER COLLECT FEATURE ends. When SUPER COLLECT FEATURE is triggered, 3 free spins are awarded.

Each newly appearing ☑ / ☚ in a free spin resets the number of remaining free spins to 3 and is held in position until the SUPER COLLECT FEATURE ends. SUPER COLLECT FEATURE starts after JACKPOT WHEEL ends if triggered in the same bought game. COLLECT FEATURE ends after all awarded free spins have been played or ☑ / ☚ appears in all 25 symbol positions. Prizes displayed on ☑ / ☚ are paid one time only for held ☑ / ☚ on the reels at the end of SUPER COLLECT FEATURE only.

If ☑ / ☚ appears in all 25 symbol positions, prizes displayed on ☑ / ☚ are doubled and paid one time only.

☑ / ☚ prizes won at the end of SUPER COLLECT FEATURE are added to the prizes from the game that triggered the SUPER COLLECT FEATURE.

JACKPOT WHEEL



There is a chance that the JACKPOT WHEEL may be triggered when 1 or more ☛ appears in bought games only. When the JACKPOT WHEEL is triggered, a wheel appears on the screen and is spun once only. After the wheel is spun, 1 wheel segment indicated by the pointer at the top of the wheel is selected.

The wheel contains the following:

BONUSES: MINI BONUS and MINOR BONUS

JACKPOTS: MAJOR JACKPOT and GRAND JACKPOT

JACKPOT WHEEL ends after a JACKPOT or BONUS is won.



ROCK PAPER SCISSORS

INSTANT WIN™



ROCK PAPER SCISSORS

INSTANT WIN



From simple hand game to a level-up Wheel Prize excitement. Win at Rock Paper Scissors to get one of the Wheel Prizes. A tie result will step up your prize level. 5 prize levels are available on the Prize Wheel, including two jackpots: and .

GAME DETAILS

GAME TYPE
ACTIV-PLAY

DENOMINATIONS
1¢

MIN/MAX BET
1 Bet up to 500 Bet

DIMENSIONS

Upright Height
(Signage Included)
125.7 in (3192 mm)

Upright Height
(Tower Light Included)
108.3 in (2756.9 mm)

Upright Height
(Tower Light Excluded)
104.4 in (2652.5 mm)

Signage Height
31.9 in (810 mm)

Width
31.9 in (810 mm)

Depth
27 in (686.6 mm)



GAME FEATURES

		GAMES COMPUTER HAND		
PLAYER'S HAND		ROCK	PAPER	SCISSORS
	ROCK	TIE	LOSE	WIN
PAPER	WIN	TIE	LOSE	
SCISSORS	LOSE	WIN	TIE	

The player wins the game by winning at rock paper scissors against the machine.

If the player wins, a prize from the Prize Wheel is won.

When the player's HAND wins, 1 prize is won as indicated by the prize wheel on the game screen, and the game ends.

If both the player and the game machine throw the same HAND, the game is a TIE and 1 more game is played at no cost.

The prize wheel level starts at 1 in the first game and increments 1 level higher in each game following a TIE until the maximum prize wheel level of 5 is reached.



BET CONFIGURATIONS



Default: 5, 10, 15, 20, 25
Available Bet: 1, 2, 3, 4, 5, 6, 7, 8, 9, 10, 12, 15, 20, 25, 30, 40, 50, 75, 100, 150, 200, 250, 500

Client can select from any AVAILABLE BET and from 1 to 5 free layout display.

JACKPOT STARTUP (\$1)

SETTINGS	GRAND	MAJOR
Setting 1	\$2,000	\$250
Setting 2	\$2,000	\$500
Setting 3	\$5,000	\$250
Setting 4	\$5,000	\$500
Setting 5	\$10,000	\$250
Setting 6	\$10,000	\$500
Setting 7	\$20,000	\$5,000
Setting 8	\$50,000	\$5,000

Client can set desired Jackpot start up value.

MULTI-GAME BAR SUITE

CLASSIC VIDEO POKER, KENO
& SKILL-INFLUENCED THEMES



Draw your way to big wins with your favorite video poker themes designed with a classic look and sounds that keep players engaged. Combined with Keno & popular Skill-Influenced themes, this Multi-Game suite will quickly become a player's favorite.

GAME FEATURES

- Touchscreen or button play
- Traditional paytables
- Speed selection
- Supported Languages: English, Spanish, French, German, Korean, Chinese (Simplified & Traditional)

DENOMINATIONS

1¢

WAGER AMOUNT

- 5, 10, 15, 20, 25
10, 20, 30, 40, 50
25, 50, 75, 100, 125
50, 100, 150, 200, 250
100, 200, 300, 400, 500
(Game displays denomination of base wager amount)

SKILL-INFLUENCED SUITE



SAFARI MATCH



SAFARI KENO



CANDY PATROL



MAHJONG



LUCKY JELLY JACKPOT





CLASS II SYSTEM OVERVIEW

Jogo Bingo Core 2 is a Class 2 solution with a complete EGM platform + Bingo Server solution + Game Runtime for quick land-based game porting of Class 3 games to the tribal Class 2 market.

Providing mathematical tools for Class 3 to Class 2 math model conversion and a rapid game development framework, JBC2 class 2 solution uncomplacates and speeds up the time to market of Class 2 variants of Class 3 game libraries.

FEATURES & BENEFITS

- Excellent Player Retention
- Performance Tested Solutions
- Easy Integration to Loyalty Programs
- Stand Out Play Synergy Slot Content in Class 2
- Legal and Regulated – compliant and certified game content
- Jackpots and Bonuses – engaging and compelling game content
- Expanded Game Library – no restrictions on what can be achieved
- Compared to other Class game content,
Class 2 usually operates with lower costs for casinos

GAMES AVAILABLE ON THE CLASS II SYSTEM

- Super Sun Mayan Heat
- Super Sun Savannah Heat



Bar Top Games (Class 2)



TYPE OF FEATURES

Multi Game
5 Most Popular Poker Games

DENOMINATIONS

1c, 5c, 25c, 50c, \$1

NUMBER OF HANDS

1, 3, 6, 9, 12

MAX BET

\$60
(12 Hands @ \$1)



No more fixed poker. Big Bear Poker is real skill-based video poker. Our USPTO patent protected intellectual property is a Class II bingo math model that mimics Class II with a simulated accuracy of 99%.

SKILL-BASED CLASS II VIDEO POKER



Our bingo games use patterns to draw draw cards and symbols just like Class II.
Highly configurable: support low, medium and high limits.
Operator can configure up to 5 games.



Deuces Wild!
3 Hand Play



Jacks or Better!
6 Hand Play



2x 2x Bonus!
12 Hand Play



27" 2600 Bar Top Cabinet



The Golden Frog Baccarat is a commission free version* of baccarat where a three-card Banker win with a total of 7 results in a Banker push. The Player and Tie bets pay the same as standard baccarat. Our SMRT SHOE and SMRT BOARD allows casinos to eliminate dealer errors and needless keypad entries, while providing valuable gaming data for analytics and game protection.

In addition to the base game, there are five more betting options:

- Koi 8: A wager that the Player hand will win with a three-card total of 8 pays 25 to 1
- Jin Chan 7: A wager that the Banker hand will win with a three-card total of 7 pays 40 to 1
- Three-Card 9 wins against a Three-Card 1 pays 150 to 1**
- Two-Card 9 wins against a Two-Card 7 pays 50 to 1**
- Any 8 wins against any 6 pays 25 to 1**

* Can be played on Traditional Baccarat

** The hand values are interchangeable between the Player and Banker hands



EMPIRE[®] Multiplier BLACKJACK



MAKE EMPIRE MULTIPLIER BLACKJACK[®]/BLACKJACK WAGER

Player makes EITHER OR BOTH the Empire Multiplier Blackjack[®] Wager and/or the Blackjack Wager in any amounts within the table limits. Player receives two cards as the initial Blackjack Hand and Dealer two card, one face down and one face up. Player evaluates his Blackjack Hand.

All Other Player wins in Empire Multiplier Blackjack[®]/Blackjack pay Even Money. Blackjack wins pay per House Rules.

PLAY & PROCEDURES

Game is dealt and played as traditional Blackjack with the above special provision and Pay Table. All standard Blackjack House Rules apply, including those for splitting hands and doubling down. Dealer hit soft 17.

Empire Multiplier Blackjack[®]
Up to two Wager on the same Blackjack Hand

ODDS PAID UP TO 4X IN PLAY OF THE GAME

When Player wins on a Dealer bust, Dealer pays up to 4X all winning Empire Multiplier Blackjack[®] Wager still in action per the following Pay Table:

PAYTABLE	
BUST WITH 6	4:1
BUST WITH 7	3:1
BUST WITH 8	3:2
BUST WITH 9	3:2
BUST WITH J, Q, or K	1:2
BUST WITH NATURAL 10	PUSH
ANY OTHER WIN	1:1
BLACKJACK	3:2



play synergy

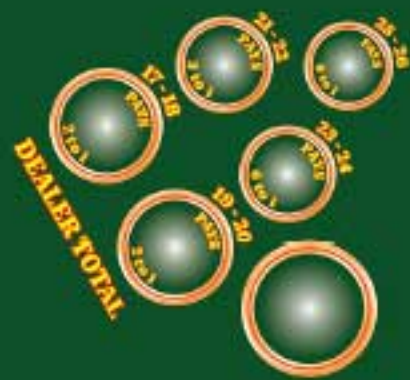

Dealer Total	Pays
17 / 18	2 to 1
19 / 20	3 to 1
21 / 22	6 to 1
23 / 24	9 to 1

DEALER MUST HIT A SOFT 17
PAYS 2 to 1
INSURANCE PAYS 2 to 1
BLACKJACK PAYS 3 to 2

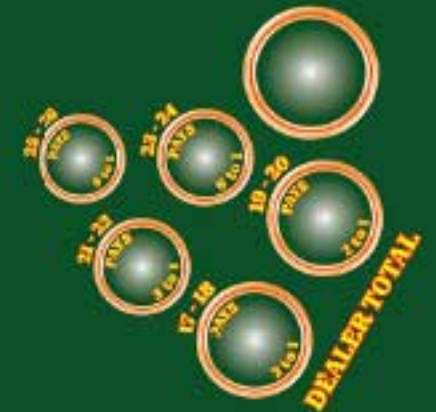

Dealer Total	Pays
17 / 18	2 to 1
19 / 20	3 to 1
21 / 22	6 to 1
23 / 24	9 to 1
25 / 26	9 to 1



Dealer Total	Pays
17 / 18	2 to 1
19 / 20	3 to 1
21 / 22	6 to 1
23 / 24	9 to 1
25 / 26	9 to 1



Players want more ways to win and "Step It Up" Blackjack gives them what they want. Blackjack with extra bets on the dealers total – it's easy. Simple to understand and more fun to play!

Traditional Blackjack rules apply and the dealer hits on Soft 17.

Players place the primary wager and may place a "Step it Up" wager on one or more of the side bet locations.

The player wins the "Step it Up" Blackjack side wager if they placed a wager in the betting location that corresponds with the dealer's final card total.

Winning wagers are paid according to the pay table.

Table Game Directors love "Step it Up" Blackjack:

- Simple game with a short learning curve
- No special training required for dealers
- Easy game for Surveillance viewing
- Casinos can offer an exciting new way to play Blackjack with a higher net win per table
- Attractive payable for players, balanced with profitable house edge percentages



**A NEW WAY TO PLAY HOLD'EM SHORTER DECK.
BETTER HAND!**

**SHORTER DECK (6+)
HOLD'EM HAND RANKINGS**

- Royal Flush
- Straight Flush (including A-6-7-8-9)
- Four-of-a-Kind
- Flush
- Full House
- Three-of-a-Kind
- Straight (including A-6-7-8-9)
- Two Pair
- One Pair
- High Card



Hole Cards Bonus Pay Table

Hand	Pays "to 1"
Black AA vs. Red AA	1000
AA vs. AA	250
AA	15
AK Suited	13
A with Q or J Suited	9
AK Unsuitd	7
A with Q or J Unsuitd	4
Any Pair	2

6+ Bonus Pay Table

Hand(s)	Pays "to 1"
Royal Flush	100 to 1
Straight Flush	50 to 1
4 of a Kind	15 to 1
Flush	7 to 1
Full House	4 to 1
3 of a Kind	2 to 1

Play Aruze's best games online!

For inquiries, contact: info@aruze-interactive.com



Aruze has brought its high performing land-based content online with a library of over 30 games and growing.

Enjoy Free to Play games at your leisure!

Aruze Interactive is a key growth segment for Aruze Gaming.

Aruze has begun development of new and innovative "Digital First" games.

We are targeting the regulated real money gaming markets in North America, Latin America, and Europe.

Aruze content is also available for Social Gaming.

Aruze has been live in NJ for over a year and will be expanding into other regulated states in the US soon.



Whether you are at home or on the go, you can always locate your favorite Aruze games!



Zynga - HIT IT RICH



LUCKY NORTH CASINO



BEST BET CASINO



SUPER LUCKY CASINO



TROPWORLD CASINO



GSN - WHEEL OF FORTUNE



MAGICIAN CASINO 2



INNOVATION REBORN



Aruze Gaming Global HQ
1106 Palms Airport Dr
Las Vegas, NV 89119
TEL: +1 702-781-8080
EMAIL: info@aruze-gaming.com

Aruze Gaming Global Central Office

10447 Lemoyne Blvd Biloxi, MS 39532
TEL: +1 702-781-8080

Customer Technical Support

Available 24 hours a day / 7 days a week
TEL: +1 877-438-0569
EMAIL: tech@aruze-gaming.com

Empire Technological Group Japan K.K

1-2-7, Kandasudacho Awajichouekimae Bldg. 3F.
Chiyoda-Ku, Tokyo, 101-0041 Japan

Empire Shared Services Philippines, Inc.

Ayala Tower One 1105-1106, 6767 Ayala Avenue
Corner Paseo de Roxas, Makati, Philippines

Aruze Gaming Africa PTY LTD.

P.O. Box 11484, Vorna Valley 1684 Unit 1/2/3 Kyalami
Village 57 Fornsman Close, Barbeque Downs Ext. 1
Kyalami, Midrand, Gauteng, South Africa
TEL: +27 11-466-3388 FAX: +27 11-466-3389

Aruze Gaming Australia PTY LTD.

Unit 6, 463 Victoria Street, Wetherill Park,
NSW 2164, Australia
TEL: +61 2-8332-6000
EMAIL: sales@aruzegaming.com.au

**Empire Technological Group Limited
- Macau Branch**

Avenida Xian Xing Hai, Centro Golden Dragon,
11 Andar N, Macau

CONFIDENTIAL

For Aruze Customer's Internal use only
Do Not Otherwise Reproduce or Disclose

Follow us @AruzeGaming



www.aruzegaming.com